



elcom 2.0

INDICE INDEX

STRIPLED & NEONFLEX

STRIPLED



da pag. 28 a pag.107

NEONFLEX

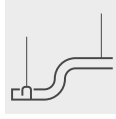

da pag. 108 a pag.123

PROFILI/PROFILE

TERMOPLASTICI/THERMOPLASTICS



1710TP
plafone
ceiling-wall
Pag. 132



1912TP
plafone
ceiling-wall
Pag. 133



2020TP
angolare
angular
Pag. 134



2612TP
plafone
ceiling-wall
Pag. 135

ECO

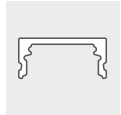

38
surface
Pag. 138

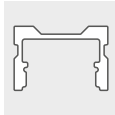

42
surface
low
Pag. 139

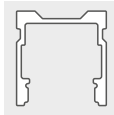

43
surface
Pag. 140



40
corner
Pag. 141

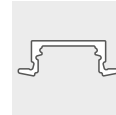

39
recessed
Pag. 142

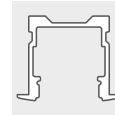

45
recessed
Pag. 143

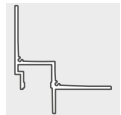

44
recessed
trimless
Pag. 144

PLAFONE/APPLIQUE/CEILING-WALL/APPLIQUE

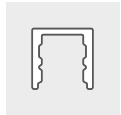

0808
plafone
ceiling-wall
Pag. 148



1508/1510
plafone
ceiling-wall
Pag. 149



1805 flex
plafone
ceiling-wall
Pag. 150



**1807T
TESATA**
stretched
Pag. 151

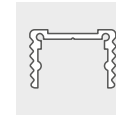

1813
plafone
ceiling-wall
Pag. 152

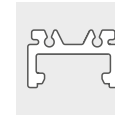

1912
plafone
ceiling-wall
Pag. 154

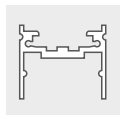

2421
plafone
ceiling-wall
Pag. 155

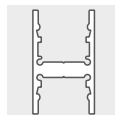

3031
applique
Pag. 156

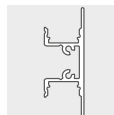

4817
applique
Pag. 158

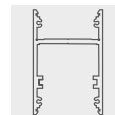

4731
applique/
plafone
ceiling-wall
Pag. 160

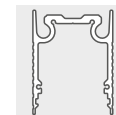

3546
plafone
ceiling-wall
Pag. 162

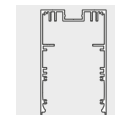

5690
plafone
ceiling-wall
Pag. 163

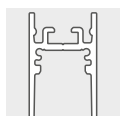

1828
plafone
ceiling-wall
Pag. 164

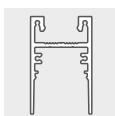

2743
plafone
ceiling-wall
Pag. 165

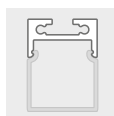

2027
plafone
ceiling-wall
Pag. 166

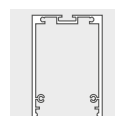

7336
plafone
ceiling-wall
Pag. 167

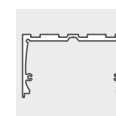

5634
plafone
ceiling-wall
Pag. 168



2110
plafone
ceiling-wall
Pag. 169

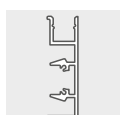

5015
plafone
ceiling-wall
Pag. 170



4317
applique
Pag. 171

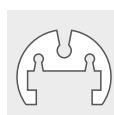

D20
plafone
ceiling-wall
Pag. 172



D40
plafone
ceiling-wall
Pag. 173

SOSPENSIONE/SUSPENSION

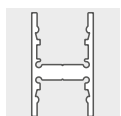

3031
Pag. 156

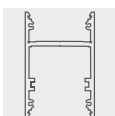

4731
Pag. 160

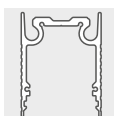

3546
Pag. 162

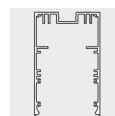

5690
Pag. 163

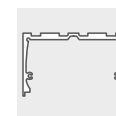

5634
Pag. 168

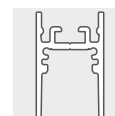

1828
Pag. 164

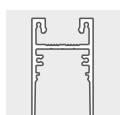

2743
Pag. 165

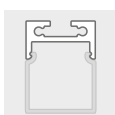

2027
Pag. 166

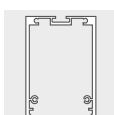

7336
Pag. 167



D40
Pag. 173

INDICE INDEX

ANGOLARI/ANGULAR



INCASSO A BATTUTA/RECESSED DOWNLIGHT

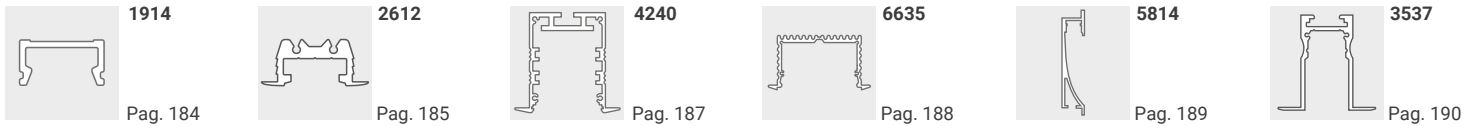

INCASSO CALPESTABILE/WALKABLE RECESSED

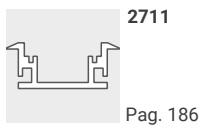

DRYWALL - SISTEMA CARTONGESSO / SYSTEM FRAMEWORK



INCASSO A RASO/FLUSH RECESSED

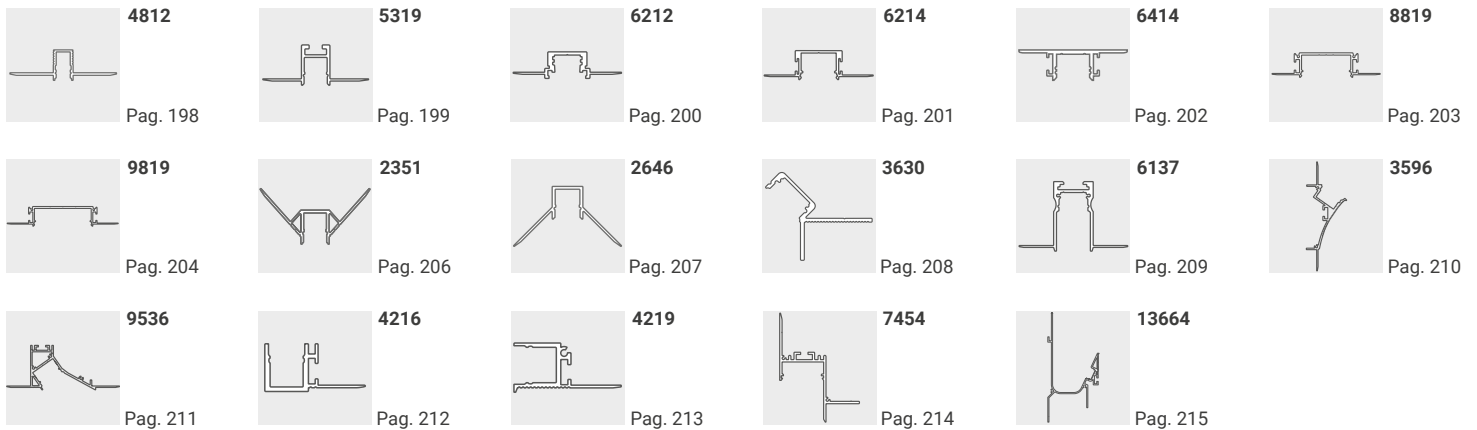

XPS/PU/EPS INCASSI IN CARTONGESSO/RECESSED IN PLASTERBOARD

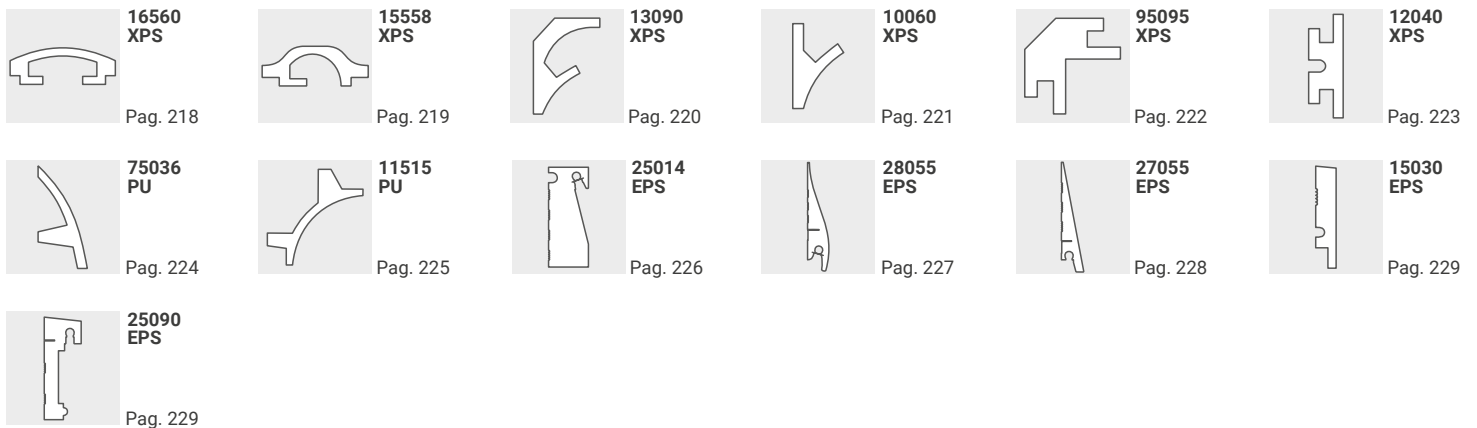

PROFILI ESTERNO/PROFILE OUTDOOR

PLAFONE/CEILING-WALL



INCASSO CALPESTABILE/WALKABLE RECESSED

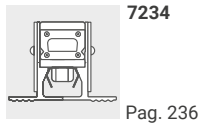

BINARI/TRACKS

BINARI ELETTRIFICATI/ELECTRIFIED TRACKS

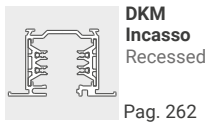
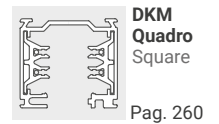
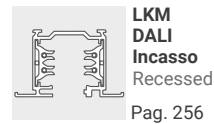
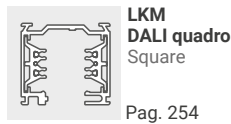
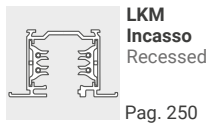
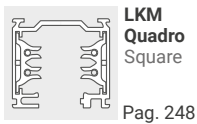
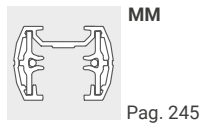

FARETTI A BINARIO/TRACK LIGHTS

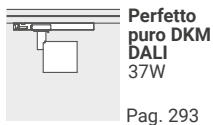
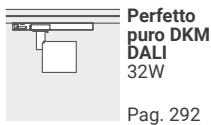
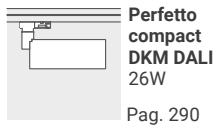
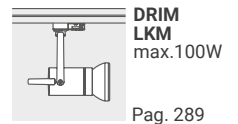
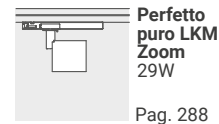
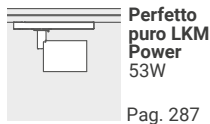
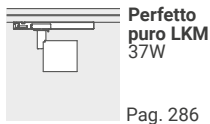
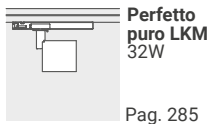
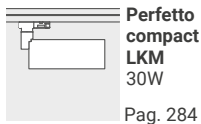
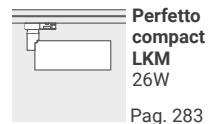
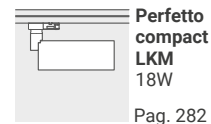
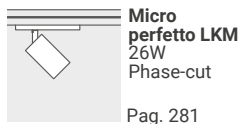
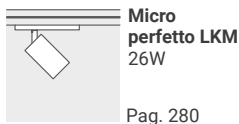
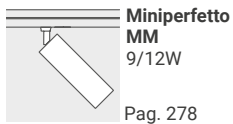

BINARI ELETTRIFICATI 48VDC/ELECTRIFIED TRACKS 48VDC

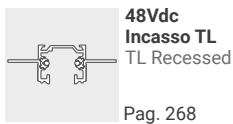
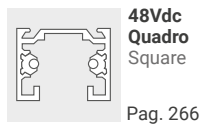



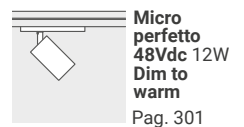
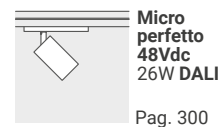
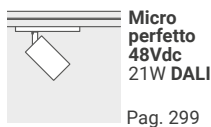
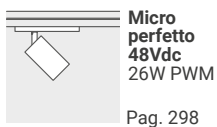
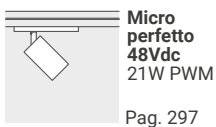
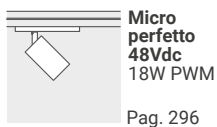







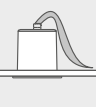
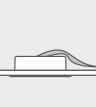
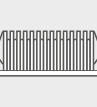
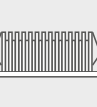
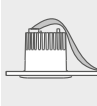
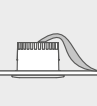
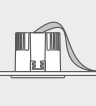
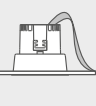
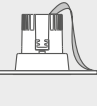

FARETTI A BINARIO 48VDC/TRACK LIGHTS 48VDC

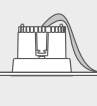





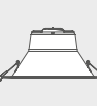
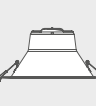
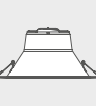

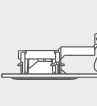
INDICE INDEX

FARETTI/SPOTLIGHTS

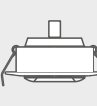
FARETTI DA INCASSO/RECESSED SPOTLIGHTS

 Nary 30 1,2W Pag. 304	 Copenhagen 41 3W Pag. 305	 RA 4 4,6W Pag. 306	 RA 7 4,6W Pag. 307	 Vienna 70 4,5W Pag. 308	 Monaco 70 4,5W Pag. 309
 RA 8 DIXIT LED 9/12W Pag. 310	 RA 8 L DIXIT LED 5,5/8,5W Pag. 311	 RA 8 Q DIXIT LED 9/12W Pag. 312	 RA 8 L TL DIXIT LED 5,5/8,5W Pag. 314	 RA 8 TL DIXIT LED 9/12W Pag. 315	 RA 11 DIXIT LED 12/18/26W Pag. 316
 RA 11 Q DIXIT LED 12/18/26W Pag. 317	 RA 11 TL DIXIT LED 12/18/26W Pag. 318	 RA 16 18/26W Pag. 319	 Sao 113 10W Pag. 320	 Sao 174 17W Pag. 321	 Sao 244 25W Pag. 322
 Sao 279 40W Pag. 323	 Downlight 113 10W Pag. 324	 Downlight 174 20W Pag. 325	 Downlight 232 35W Pag. 326	 RA 14 DIXIT LED 26/33/38W Pag. 327	 RA 20 DIXIT LED 51W Pag. 328
 RA 23 SP DIXIT LED 51/75W Pag. 329					

FARETTI INCASSO ORIENTABILE/ADJUSTABLE RECESSED SPOTLIGHTS







 NICOSIA 51 3W Pag. 330	 RA 8 DIXIT LED 9/12W Pag. 331	 RA 11 DIXIT LED 12/18/26W Pag. 332	 RA 17 DIXIT LED 33W Pag. 333	 KIEV 158 38W Pag. 334	 KIEV 188 40W Pag. 335
---	---	--	--	---	---

CIELO STELLATO/STARRY SKY

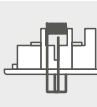
 Cielo stellato 3/9W Pag. 338

CESTELLI/BASKETS

INCASSO FISSO O ORIENTABILE/FIXED OR ADJUSTABLE RECESSED

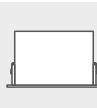
 Lakin 83 Pag. 342	 Ardea 102 Pag. 342	 Nemi 93T Pag. 343	 Nemi 93Q Pag. 343	 Madama 79 Fisso Fixed Pag. 344	 Latina 76 Fisso Fixed Pag. 344
 Sandy 86 Fisso Fixed Pag. 345	 Clark 90 Fisso Fixed Pag. 345				

INDICE INDEX

SPOTLED

■ ø50

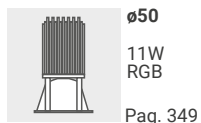
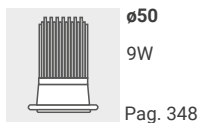
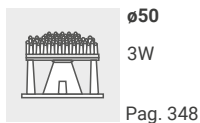

FARETTI/SPOTLIGHTS

■ FARETTI A PLAFONE/CEILING LIGHTS

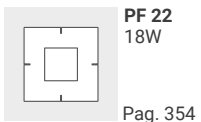
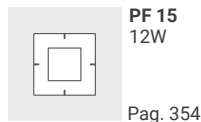
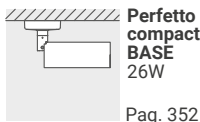

■ APPLIQUE/WALL LIGHTS

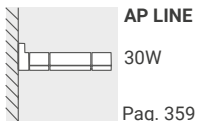
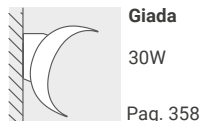

■ SOSPENSIONI/SUSPENSIONS

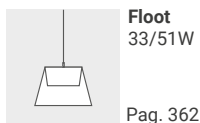

FARETTI ESTERNO/OUTDOOR SPOTLIGHTS

■ INCASSO CALPESTABILE/WALKABLE RECESSED

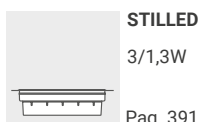
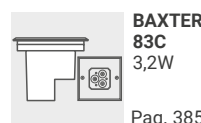
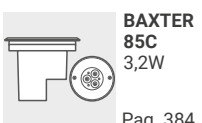
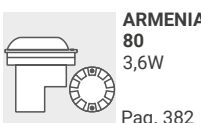
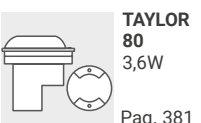
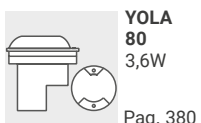
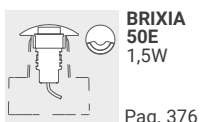
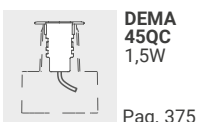
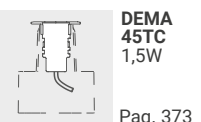
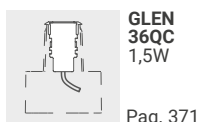

■ INCASSO A SOFFITTO/CEILING RECESSED

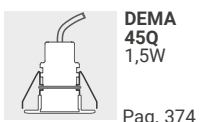
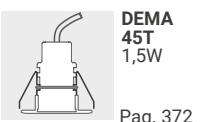

INDICE INDEX

PROIETTORI/FLOODLIGHT

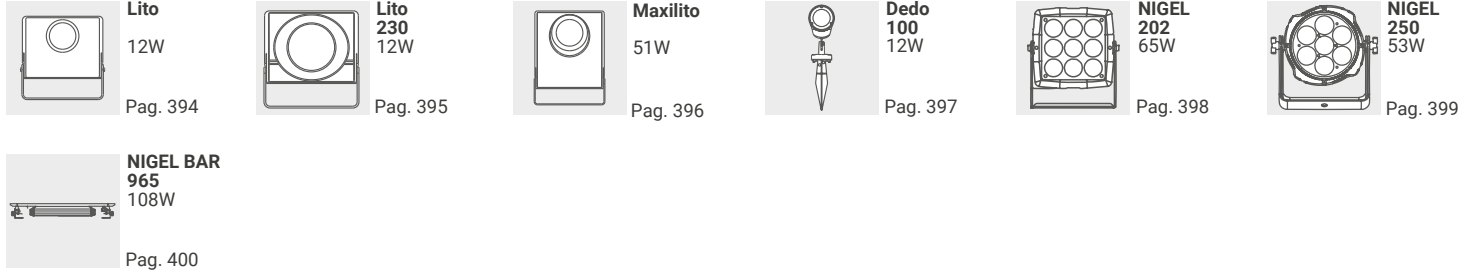

INCASSO A MURO/WALL RECESSED

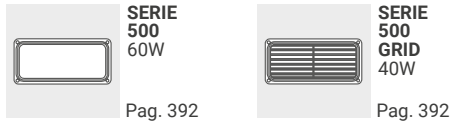

PLAFONE/CEILING

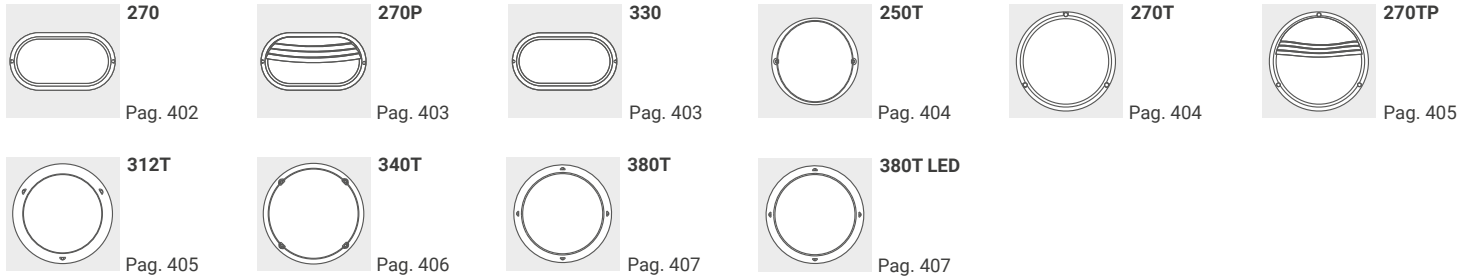

PANNELLI LED/LED PANELS

BACKLIGHT

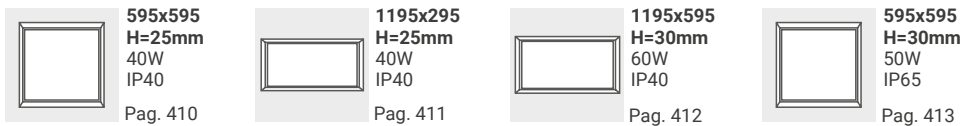

EDGE LIGHT

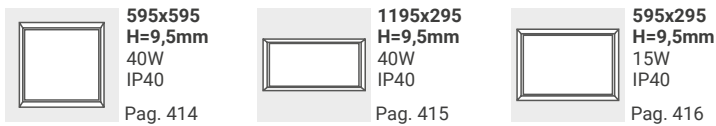

TONDO - QUADRO/ROUND - SQUARE

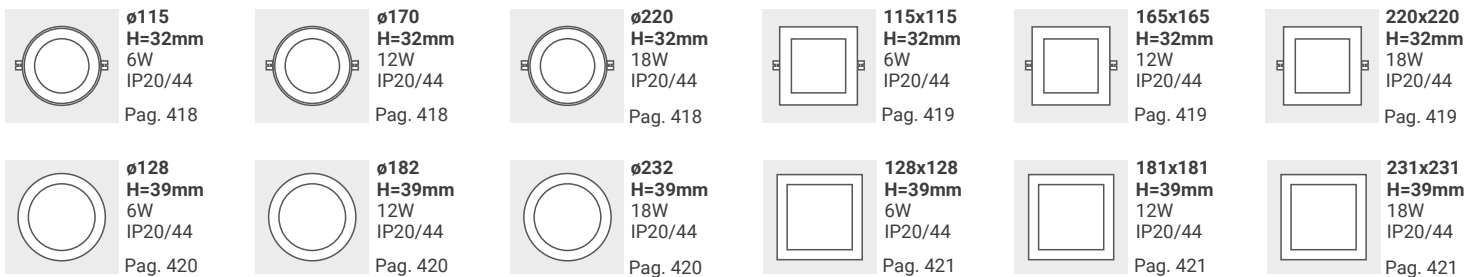

ACCESSORI PANNELLI/PANELS ACCESSORIES



ALIMENTATORI/POWER SUPPLIES

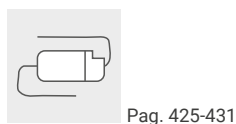

CONTROLLER

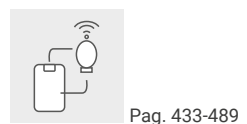

ANGOLARE
ANGULAR

INCASSI IN BATTUTA
RECESSED DOWNLIGHT

INCASSI A RASO
FLUSH RECESSED

	D20	D40	1010	1616	2020	2115	7676	6730	1914	2612	2711	4240	6635	5814	3537	4812	5319	6212	6214	6414	8819	9819	2351	2646	3630	6137	3596	9536	4216	4219	7454	13664	STRIPLED Pag.
	<input checked="" type="checkbox"/>	<input checked="" type="checkbox"/>	<input type="checkbox"/>	<input checked="" type="checkbox"/>	<input checked="" type="checkbox"/>	<input checked="" type="checkbox"/>	<input checked="" type="checkbox"/>	<input checked="" type="checkbox"/>	<input checked="" type="checkbox"/>	<input checked="" type="checkbox"/>	<input checked="" type="checkbox"/>	<input checked="" type="checkbox"/>	<input checked="" type="checkbox"/>	<input checked="" type="checkbox"/>	<input checked="" type="checkbox"/>	<input type="checkbox"/>	<input checked="" type="checkbox"/>	<input checked="" type="checkbox"/>	<input checked="" type="checkbox"/>	<input checked="" type="checkbox"/>	<input checked="" type="checkbox"/>	<input checked="" type="checkbox"/>	<input checked="" type="checkbox"/>	<input checked="" type="checkbox"/>	<input checked="" type="checkbox"/>	<input checked="" type="checkbox"/>	<input checked="" type="checkbox"/>	<input checked="" type="checkbox"/>	<input checked="" type="checkbox"/>	<input checked="" type="checkbox"/>	<input checked="" type="checkbox"/>	<input checked="" type="checkbox"/>	34
	<input checked="" type="checkbox"/>	<input checked="" type="checkbox"/>	<input type="checkbox"/>	<input type="checkbox"/>	<input checked="" type="checkbox"/>	<input checked="" type="checkbox"/>	<input checked="" type="checkbox"/>	<input checked="" type="checkbox"/>	<input type="checkbox"/>	<input checked="" type="checkbox"/>	<input checked="" type="checkbox"/>	<input checked="" type="checkbox"/>	<input checked="" type="checkbox"/>	<input checked="" type="checkbox"/>	<input checked="" type="checkbox"/>	<input type="checkbox"/>	<input checked="" type="checkbox"/>	<input checked="" type="checkbox"/>	<input checked="" type="checkbox"/>	<input checked="" type="checkbox"/>	<input checked="" type="checkbox"/>	<input checked="" type="checkbox"/>	<input checked="" type="checkbox"/>	<input checked="" type="checkbox"/>	<input checked="" type="checkbox"/>	<input checked="" type="checkbox"/>	<input checked="" type="checkbox"/>	<input checked="" type="checkbox"/>	<input checked="" type="checkbox"/>	<input checked="" type="checkbox"/>	<input checked="" type="checkbox"/>	<input checked="" type="checkbox"/>	35
	<input checked="" type="checkbox"/>	<input checked="" type="checkbox"/>	<input type="checkbox"/>	<input checked="" type="checkbox"/>	<input checked="" type="checkbox"/>	<input checked="" type="checkbox"/>	<input checked="" type="checkbox"/>	<input checked="" type="checkbox"/>	<input checked="" type="checkbox"/>	<input checked="" type="checkbox"/>	<input checked="" type="checkbox"/>	<input checked="" type="checkbox"/>	<input checked="" type="checkbox"/>	<input checked="" type="checkbox"/>	<input checked="" type="checkbox"/>	<input type="checkbox"/>	<input checked="" type="checkbox"/>	<input checked="" type="checkbox"/>	<input checked="" type="checkbox"/>	<input checked="" type="checkbox"/>	<input checked="" type="checkbox"/>	<input checked="" type="checkbox"/>	<input checked="" type="checkbox"/>	<input checked="" type="checkbox"/>	<input checked="" type="checkbox"/>	<input checked="" type="checkbox"/>	<input checked="" type="checkbox"/>	<input checked="" type="checkbox"/>	<input checked="" type="checkbox"/>	<input checked="" type="checkbox"/>	<input checked="" type="checkbox"/>	<input checked="" type="checkbox"/>	36
	<input checked="" type="checkbox"/>	<input checked="" type="checkbox"/>	<input type="checkbox"/>	<input checked="" type="checkbox"/>	<input checked="" type="checkbox"/>	<input checked="" type="checkbox"/>	<input checked="" type="checkbox"/>	<input checked="" type="checkbox"/>	<input checked="" type="checkbox"/>	<input checked="" type="checkbox"/>	<input checked="" type="checkbox"/>	<input checked="" type="checkbox"/>	<input checked="" type="checkbox"/>	<input checked="" type="checkbox"/>	<input checked="" type="checkbox"/>	<input type="checkbox"/>	<input checked="" type="checkbox"/>	<input checked="" type="checkbox"/>	<input checked="" type="checkbox"/>	<input checked="" type="checkbox"/>	<input checked="" type="checkbox"/>	<input checked="" type="checkbox"/>	<input checked="" type="checkbox"/>	<input checked="" type="checkbox"/>	<input checked="" type="checkbox"/>	<input checked="" type="checkbox"/>	<input checked="" type="checkbox"/>	<input checked="" type="checkbox"/>	<input checked="" type="checkbox"/>	<input checked="" type="checkbox"/>	<input checked="" type="checkbox"/>	<input checked="" type="checkbox"/>	37
	<input checked="" type="checkbox"/>	<input checked="" type="checkbox"/>	<input type="checkbox"/>	<input type="checkbox"/>	<input checked="" type="checkbox"/>	<input checked="" type="checkbox"/>	<input checked="" type="checkbox"/>	<input checked="" type="checkbox"/>	<input type="checkbox"/>	<input checked="" type="checkbox"/>	<input checked="" type="checkbox"/>	<input checked="" type="checkbox"/>	<input checked="" type="checkbox"/>	<input checked="" type="checkbox"/>	<input checked="" type="checkbox"/>	<input type="checkbox"/>	<input checked="" type="checkbox"/>	<input checked="" type="checkbox"/>	<input checked="" type="checkbox"/>	<input checked="" type="checkbox"/>	<input checked="" type="checkbox"/>	<input checked="" type="checkbox"/>	<input checked="" type="checkbox"/>	<input checked="" type="checkbox"/>	<input checked="" type="checkbox"/>	<input checked="" type="checkbox"/>	<input checked="" type="checkbox"/>	<input checked="" type="checkbox"/>	<input checked="" type="checkbox"/>	<input checked="" type="checkbox"/>	<input checked="" type="checkbox"/>	<input checked="" type="checkbox"/>	38
	<input checked="" type="checkbox"/>	<input checked="" type="checkbox"/>	<input type="checkbox"/>	<input checked="" type="checkbox"/>	<input checked="" type="checkbox"/>	<input checked="" type="checkbox"/>	<input checked="" type="checkbox"/>	<input checked="" type="checkbox"/>	<input checked="" type="checkbox"/>	<input checked="" type="checkbox"/>	<input checked="" type="checkbox"/>	<input checked="" type="checkbox"/>	<input checked="" type="checkbox"/>	<input checked="" type="checkbox"/>	<input checked="" type="checkbox"/>	<input type="checkbox"/>	<input checked="" type="checkbox"/>	<input checked="" type="checkbox"/>	<input checked="" type="checkbox"/>	<input checked="" type="checkbox"/>	<input checked="" type="checkbox"/>	<input checked="" type="checkbox"/>	<input checked="" type="checkbox"/>	<input checked="" type="checkbox"/>	<input checked="" type="checkbox"/>	<input checked="" type="checkbox"/>	<input checked="" type="checkbox"/>	<input checked="" type="checkbox"/>	<input checked="" type="checkbox"/>	<input checked="" type="checkbox"/>	<input checked="" type="checkbox"/>	<input checked="" type="checkbox"/>	42
	<input checked="" type="checkbox"/>	<input checked="" type="checkbox"/>	<input type="checkbox"/>	<input checked="" type="checkbox"/>	<input checked="" type="checkbox"/>	<input checked="" type="checkbox"/>	<input checked="" type="checkbox"/>	<input checked="" type="checkbox"/>	<input checked="" type="checkbox"/>	<input checked="" type="checkbox"/>	<input checked="" type="checkbox"/>	<input checked="" type="checkbox"/>	<input checked="" type="checkbox"/>	<input checked="" type="checkbox"/>	<input checked="" type="checkbox"/>	<input type="checkbox"/>	<input checked="" type="checkbox"/>	<input checked="" type="checkbox"/>	<input checked="" type="checkbox"/>	<input checked="" type="checkbox"/>	<input checked="" type="checkbox"/>	<input checked="" type="checkbox"/>	<input checked="" type="checkbox"/>	<input checked="" type="checkbox"/>	<input checked="" type="checkbox"/>	<input checked="" type="checkbox"/>	<input checked="" type="checkbox"/>	<input checked="" type="checkbox"/>	<input checked="" type="checkbox"/>	<input checked="" type="checkbox"/>	<input checked="" type="checkbox"/>	<input checked="" type="checkbox"/>	43
	<input checked="" type="checkbox"/>	<input checked="" type="checkbox"/>	<input type="checkbox"/>	<input checked="" type="checkbox"/>	<input checked="" type="checkbox"/>	<input checked="" type="checkbox"/>	<input checked="" type="checkbox"/>	<input checked="" type="checkbox"/>	<input checked="" type="checkbox"/>	<input checked="" type="checkbox"/>	<input checked="" type="checkbox"/>	<input checked="" type="checkbox"/>	<input checked="" type="checkbox"/>	<input checked="" type="checkbox"/>	<input checked="" type="checkbox"/>	<input type="checkbox"/>	<input checked="" type="checkbox"/>	<input checked="" type="checkbox"/>	<input checked="" type="checkbox"/>	<input checked="" type="checkbox"/>	<input checked="" type="checkbox"/>	<input checked="" type="checkbox"/>	<input checked="" type="checkbox"/>	<input checked="" type="checkbox"/>	<input checked="" type="checkbox"/>	<input checked="" type="checkbox"/>	<input checked="" type="checkbox"/>	<input checked="" type="checkbox"/>	<input checked="" type="checkbox"/>	<input checked="" type="checkbox"/>	<input checked="" type="checkbox"/>	<input checked="" type="checkbox"/>	44
	<input checked="" type="checkbox"/>	<input checked="" type="checkbox"/>	<input type="checkbox"/>	<input checked="" type="checkbox"/>	<input checked="" type="checkbox"/>	<input checked="" type="checkbox"/>	<input checked="" type="checkbox"/>	<input checked="" type="checkbox"/>	<input type="checkbox"/>	<input checked="" type="checkbox"/>	<input checked="" type="checkbox"/>	<input checked="" type="checkbox"/>	<input checked="" type="checkbox"/>	<input checked="" type="checkbox"/>	<input checked="" type="checkbox"/>	<input type="checkbox"/>	<input checked="" type="checkbox"/>	<input checked="" type="checkbox"/>	<input checked="" type="checkbox"/>	<input checked="" type="checkbox"/>	<input checked="" type="checkbox"/>	<input checked="" type="checkbox"/>	<input checked="" type="checkbox"/>	<input checked="" type="checkbox"/>	<input checked="" type="checkbox"/>	<input checked="" type="checkbox"/>	<input checked="" type="checkbox"/>	<input checked="" type="checkbox"/>	<input checked="" type="checkbox"/>	<input checked="" type="checkbox"/>	<input checked="" type="checkbox"/>	<input checked="" type="checkbox"/>	45
	<input checked="" type="checkbox"/>	<input checked="" type="checkbox"/>	<input type="checkbox"/>	<input checked="" type="checkbox"/>	<input checked="" type="checkbox"/>	<input checked="" type="checkbox"/>	<input checked="" type="checkbox"/>	<input checked="" type="checkbox"/>	<input checked="" type="checkbox"/>	<input checked="" type="checkbox"/>	<input checked="" type="checkbox"/>	<input checked="" type="checkbox"/>	<input checked="" type="checkbox"/>	<input checked="" type="checkbox"/>	<input checked="" type="checkbox"/>	<input type="checkbox"/>	<input checked="" type="checkbox"/>	<input checked="" type="checkbox"/>	<input checked="" type="checkbox"/>	<input checked="" type="checkbox"/>	<input checked="" type="checkbox"/>	<input checked="" type="checkbox"/>	<input checked="" type="checkbox"/>	<input checked="" type="checkbox"/>	<input checked="" type="checkbox"/>	<input checked="" type="checkbox"/>	<input checked="" type="checkbox"/>	<input checked="" type="checkbox"/>	<input checked="" type="checkbox"/>	<input checked="" type="checkbox"/>	<input checked="" type="checkbox"/>	<input checked="" type="checkbox"/>	48
	<input checked="" type="checkbox"/>	<input checked="" type="checkbox"/>	<input type="checkbox"/>	<input checked="" type="checkbox"/>	<input checked="" type="checkbox"/>	<input checked="" type="checkbox"/>	<input checked="" type="checkbox"/>	<input checked="" type="checkbox"/>	<input checked="" type="checkbox"/>	<input checked="" type="checkbox"/>	<input checked="" type="checkbox"/>	<input checked="" type="checkbox"/>	<input checked="" type="checkbox"/>	<input checked="" type="checkbox"/>	<input checked="" type="checkbox"/>	<input type="checkbox"/>	<input checked="" type="checkbox"/>	<input checked="" type="checkbox"/>	<input checked="" type="checkbox"/>	<input checked="" type="checkbox"/>	<input checked="" type="checkbox"/>	<input checked="" type="checkbox"/>	<input checked="" type="checkbox"/>	<input checked="" type="checkbox"/>	<input checked="" type="checkbox"/>	<input checked="" type="checkbox"/>	<input checked="" type="checkbox"/>	<input checked="" type="checkbox"/>	<input checked="" type="checkbox"/>	<input checked="" type="checkbox"/>	<input checked="" type="checkbox"/>	<input checked="" type="checkbox"/>	49
	<input checked="" type="checkbox"/>	<input checked="" type="checkbox"/>	<input type="checkbox"/>	<input checked="" type="checkbox"/>	<input checked="" type="checkbox"/>	<input checked="" type="checkbox"/>	<input checked="" type="checkbox"/>	<input checked="" type="checkbox"/>	<input checked="" type="checkbox"/>	<input checked="" type="checkbox"/>	<input checked="" type="checkbox"/>	<input checked="" type="checkbox"/>	<input checked="" type="checkbox"/>	<input checked="" type="checkbox"/>	<input checked="" type="checkbox"/>	<input type="checkbox"/>	<input checked="" type="checkbox"/>	<input checked="" type="checkbox"/>	<input checked="" type="checkbox"/>	<input checked="" type="checkbox"/>	<input checked="" type="checkbox"/>	<input checked="" type="checkbox"/>	<input checked="" type="checkbox"/>	<input checked="" type="checkbox"/>	<input checked="" type="checkbox"/>	<input checked="" type="checkbox"/>	<input checked="" type="checkbox"/>	<input checked="" type="checkbox"/>	<input checked="" type="checkbox"/>	<input checked="" type="checkbox"/>	<input checked="" type="checkbox"/>	<input checked="" type="checkbox"/>	50
	<input checked="" type="checkbox"/>	<input checked="" type="checkbox"/>	<input type="checkbox"/>	<input checked="" type="checkbox"/>	<input checked="" type="checkbox"/>	<input checked="" type="checkbox"/>	<input checked="" type="checkbox"/>	<input checked="" type="checkbox"/>	<input checked="" type="checkbox"/>	<input checked="" type="checkbox"/>	<input checked="" type="checkbox"/>	<input checked="" type="checkbox"/>	<input checked="" type="checkbox"/>	<input checked="" type="checkbox"/>	<input checked="" type="checkbox"/>	<input type="checkbox"/>	<input checked="" type="checkbox"/>	<input checked="" type="checkbox"/>	<input checked="" type="checkbox"/>	<input checked="" type="checkbox"/>	<input checked="" type="checkbox"/>	<input checked="" type="checkbox"/>	<input checked="" type="checkbox"/>	<input checked="" type="checkbox"/>	<input checked="" type="checkbox"/>	<input checked="" type="checkbox"/>	<input checked="" type="checkbox"/>	<input checked="" type="checkbox"/>	<input checked="" type="checkbox"/>	<input checked="" type="checkbox"/>	<input checked="" type="checkbox"/>	<input checked="" type="checkbox"/>	51
	<input type="checkbox"/>	<input type="checkbox"/>	<input type="checkbox"/>	<input type="checkbox"/>	<input type="checkbox"/>	<input type="checkbox"/>	<input type="checkbox"/>	<input type="checkbox"/>	<input type="checkbox"/>	<input type="checkbox"/>	<input type="checkbox"/>	<input type="checkbox"/>	<input type="checkbox"/>	<input type="checkbox"/>	<input type="checkbox"/>	<input type="checkbox"/>	<input type="checkbox"/>	<input type="checkbox"/>	<input type="checkbox"/>	<input type="checkbox"/>	<input type="checkbox"/>	<input type="checkbox"/>	<input type="checkbox"/>	<input type="checkbox"/>	<input type="checkbox"/>	<input type="checkbox"/>	<input type="checkbox"/>	<input type="checkbox"/>	<input type="checkbox"/>	<input type="checkbox"/>	<input type="checkbox"/>	<input type="checkbox"/>	52
	<input checked="" type="checkbox"/>	<input checked="" type="checkbox"/>	<input type="checkbox"/>	<input checked="" type="checkbox"/>	<input checked="" type="checkbox"/>	<input checked="" type="checkbox"/>	<input type="checkbox"/>	<input checked="" type="checkbox"/>	<input checked="" type="checkbox"/>	<input checked="" type="checkbox"/>	<input checked="" type="checkbox"/>	<input checked="" type="checkbox"/>	<input checked="" type="checkbox"/>	<input checked="" type="checkbox"/>	<input checked="" type="checkbox"/>	<input type="checkbox"/>	<input checked="" type="checkbox"/>	<input checked="" type="checkbox"/>	<input checked="" type="checkbox"/>	<input checked="" type="checkbox"/>	<input checked="" type="checkbox"/>	<input checked="" type="checkbox"/>	<input checked="" type="checkbox"/>	<input checked="" type="checkbox"/>	<input checked="" type="checkbox"/>	<input checked="" type="checkbox"/>	<input checked="" type="checkbox"/>	<input checked="" type="checkbox"/>	<input checked="" type="checkbox"/>	<input checked="" type="checkbox"/>	<input checked="" type="checkbox"/>	<input checked="" type="checkbox"/>	56
	<input checked="" type="checkbox"/>	<input checked="" type="checkbox"/>	<input type="checkbox"/>	<input checked="" type="checkbox"/>	<input checked="" type="checkbox"/>	<input checked="" type="checkbox"/>	<input type="checkbox"/>	<input checked="" type="checkbox"/>	<input checked="" type="checkbox"/>	<input checked="" type="checkbox"/>	<input checked="" type="checkbox"/>	<input checked="" type="checkbox"/>	<input checked="" type="checkbox"/>	<input checked="" type="checkbox"/>	<input checked="" type="checkbox"/>	<input type="checkbox"/>	<input checked="" type="checkbox"/>	<input checked="" type="checkbox"/>	<input checked="" type="checkbox"/>	<input checked="" type="checkbox"/>	<input checked="" type="checkbox"/>	<input checked="" type="checkbox"/>	<input checked="" type="checkbox"/>	<input checked="" type="checkbox"/>	<input checked="" type="checkbox"/>	<input checked="" type="checkbox"/>	<input checked="" type="checkbox"/>	<input checked="" type="checkbox"/>	<input checked="" type="checkbox"/>	<input checked="" type="checkbox"/>	<input checked="" type="checkbox"/>	<input checked="" type="checkbox"/>	57
	<input checked="" type="checkbox"/>	<input checked="" type="checkbox"/>	<input type="checkbox"/>	<input checked="" type="checkbox"/>	<input checked="" type="checkbox"/>	<input checked="" type="checkbox"/>	<input type="checkbox"/>	<input checked="" type="checkbox"/>	<input checked="" type="checkbox"/>	<input checked="" type="checkbox"/>	<input checked="" type="checkbox"/>	<input checked="" type="checkbox"/>	<input checked="" type="checkbox"/>	<input checked="" type="checkbox"/>	<input checked="" type="checkbox"/>	<input type="checkbox"/>	<input checked="" type="checkbox"/>	<input checked="" type="checkbox"/>	<input checked="" type="checkbox"/>	<input checked="" type="checkbox"/>	<input checked="" type="checkbox"/>	<input checked="" type="checkbox"/>	<input checked="" type="checkbox"/>	<input checked="" type="checkbox"/>	<input checked="" type="checkbox"/>	<input checked="" type="checkbox"/>	<input checked="" type="checkbox"/>	<input checked="" type="checkbox"/>	<input checked="" type="checkbox"/>	<input checked="" type="checkbox"/>	<input checked="" type="checkbox"/>	<input checked="" type="checkbox"/>	58
	<input checked="" type="checkbox"/>	<input checked="" type="checkbox"/>	<input type="checkbox"/>	<input checked="" type="checkbox"/>	<input checked="" type="checkbox"/>	<input checked="" type="checkbox"/>	<input type="checkbox"/>	<input checked="" type="checkbox"/>	<input type="checkbox"/>	<input checked="" type="checkbox"/>	<input checked="" type="checkbox"/>	<input checked="" type="checkbox"/>	<input checked="" type="checkbox"/>	<input checked="" type="checkbox"/>	<input checked="" type="checkbox"/>	<input type="checkbox"/>	<input checked="" type="checkbox"/>	<input checked="" type="checkbox"/>	<input checked="" type="checkbox"/>	<input checked="" type="checkbox"/>	<input checked="" type="checkbox"/>	<input checked="" type="checkbox"/>	<input checked="" type="checkbox"/>	<input checked="" type="checkbox"/>	<input checked="" type="checkbox"/>	<input checked="" type="checkbox"/>	<input checked="" type="checkbox"/>	<input checked="" type="checkbox"/>	<input checked="" type="checkbox"/>	<input checked="" type="checkbox"/>	<input checked="" type="checkbox"/>	<input checked="" type="checkbox"/>	59
	<input checked="" type="checkbox"/>	<input checked="" type="checkbox"/>	<input type="checkbox"/>	<input type="checkbox"/>	<input checked="" type="checkbox"/>	<input checked="" type="checkbox"/>	<input type="checkbox"/>	<input checked="" type="checkbox"/>	<input type="checkbox"/>	<input checked="" type="checkbox"/>	<input checked="" type="checkbox"/>	<input checked="" type="checkbox"/>	<input checked="" type="checkbox"/>	<input checked="" type="checkbox"/>	<input checked="" type="checkbox"/>	<input type="checkbox"/>	<input checked="" type="checkbox"/>	<input checked="" type="checkbox"/>	<input checked="" type="checkbox"/>	<input checked="" type="checkbox"/>	<input checked="" type="checkbox"/>	<input checked="" type="checkbox"/>	<input checked="" type="checkbox"/>	<input checked="" type="checkbox"/>	<input checked="" type="checkbox"/>	<input checked="" type="checkbox"/>	<input checked="" type="checkbox"/>	<input checked="" type="checkbox"/>	<input checked="" type="checkbox"/>	<input checked="" type="checkbox"/>	<input checked="" type="checkbox"/>	<input checked="" type="checkbox"/>	60
	<input checked="" type="checkbox"/>	<input checked="" type="checkbox"/>	<input type="checkbox"/>	<input checked="" type="checkbox"/>	<input checked="" type="checkbox"/>	<input checked="" type="checkbox"/>	<input checked="" type="checkbox"/>	<input checked="" type="checkbox"/>	<input checked="" type="checkbox"/>	<input checked="" type="checkbox"/>	<input checked="" type="checkbox"/>	<input checked="" type="checkbox"/>	<input checked="" type="checkbox"/>	<input checked="" type="checkbox"/>	<input checked="" type="checkbox"/>	<input type="checkbox"/>	<input checked="" type="checkbox"/>	<input checked="" type="checkbox"/>	<input checked="" type="checkbox"/>	<input checked="" type="checkbox"/>	<input checked="" type="checkbox"/>	<input checked="" type="checkbox"/>	<input checked="" type="checkbox"/>	<input checked="" type="checkbox"/>	<input checked="" type="checkbox"/>	<input checked="" type="checkbox"/>	<input checked="" type="checkbox"/>	<input checked="" type="checkbox"/>	<input checked="" type="checkbox"/>	<input checked="" type="checkbox"/>	<input checked="" type="checkbox"/>	<input checked="" type="checkbox"/>	66
	<input checked="" type="checkbox"/>	<input checked="" type="checkbox"/>	<input type="checkbox"/>	<input checked="" type="checkbox"/>	<input checked="" type="checkbox"/>	<input checked="" type="checkbox"/>	<input checked="" type="checkbox"/>	<input checked="" type="checkbox"/>	<input checked="" type="checkbox"/>	<input checked="" type="checkbox"/>	<input checked="" type="checkbox"/>	<input checked="" type="checkbox"/>	<input checked="" type="checkbox"/>	<input checked="" type="checkbox"/>	<input checked="" type="checkbox"/>	<input type="checkbox"/>	<input checked="" type="checkbox"/>	<input checked="" type="checkbox"/>	<input checked="" type="checkbox"/>	<input checked="" type="checkbox"/>	<input checked="" type="checkbox"/>	<input checked="" type="checkbox"/>	<input checked="" type="checkbox"/>	<input checked="" type="checkbox"/>	<input checked="" type="checkbox"/>	<input checked="" type="checkbox"/>	<input checked="" type="checkbox"/>	<input checked="" type="checkbox"/>	<input checked="" type="checkbox"/>	<input checked="" type="checkbox"/>	<input checked="" type="checkbox"/>	<input checked="" type="checkbox"/>	67
	<input checked="" type="checkbox"/>	<input checked="" type="checkbox"/>	<input type="checkbox"/>	<input checked="" type="checkbox"/>	<input checked="" type="checkbox"/>	<input checked="" type="checkbox"/>	<input checked="" type="checkbox"/>	<input checked="" type="checkbox"/>	<input checked="" type="checkbox"/>	<input checked="" type="checkbox"/>	<input checked="" type="checkbox"/>	<input checked="" type="checkbox"/>	<input checked="" type="checkbox"/>	<input checked="" type="checkbox"/>	<input checked="" type="checkbox"/>	<input type="checkbox"/>	<input checked="" type="checkbox"/>	<input checked="" type="checkbox"/>	<input checked="" type="checkbox"/>	<input checked="" type="checkbox"/>	<input checked="" type="checkbox"/>	<input checked="" type="checkbox"/>	<input checked="" type="checkbox"/>	<input checked="" type="checkbox"/>	<input checked="" type="checkbox"/>	<input checked="" type="checkbox"/>	<input checked="" type="checkbox"/>	<input checked="" type="checkbox"/>	<input checked="" type="checkbox"/>	<input checked="" type="checkbox"/>	<input checked="" type="checkbox"/>	<input checked="" type="checkbox"/>	68
	<input checked="" type="checkbox"/>	<input checked="" type="checkbox"/>	<input type="checkbox"/>	<input checked="" type="checkbox"/>	<input checked="" type="checkbox"/>	<input checked="" type="checkbox"/>	<input checked="" type="checkbox"/>	<input checked="" type="checkbox"/>	<input type="checkbox"/>	<input checked="" type="checkbox"/>	<input checked="" type="checkbox"/>	<input checked="" type="checkbox"/>	<input checked="" type="checkbox"/>	<input checked="" type="checkbox"/>	<input checked="" type="checkbox"/>	<input type="checkbox"/>	<input type="checkbox"/>	<input type="checkbox"/>	<input type="checkbox"/>	<input type="checkbox"/>	<input type="checkbox"/>	<input type="checkbox"/>	<input type="checkbox"/>	<input type="checkbox"/>	<input type="checkbox"/>	<input type="checkbox"/>	<input type="checkbox"/>	<input type="checkbox"/>	<input type="checkbox"/>	<input type="checkbox"/>	<input type="checkbox"/>	<input type="checkbox"/>	69
	<input checked="" type="checkbox"/>	<input checked="" type="checkbox"/>	<input type="checkbox"/>	<input checked="" type="checkbox"/>	<input checked="" type="checkbox"/>	<input checked="" type="checkbox"/>	<input checked="" type="checkbox"/>	<input checked="" type="checkbox"/>	<input type="checkbox"/>	<input checked="" type="checkbox"/>	<input checked="" type="checkbox"/>	<input checked="" type="checkbox"/>	<input checked="" type="checkbox"/>	<input checked="" type="checkbox"/>	<input checked="" type="checkbox"/>	<input type="checkbox"/>	<input type="checkbox"/>	<input type="checkbox"/>	<input type="checkbox"/>	<input type="checkbox"/>	<input type="checkbox"/>	<input type="checkbox"/>	<input type="checkbox"/>	<input type="checkbox"/>	<input type="checkbox"/>	<input type="checkbox"/>	<input type="checkbox"/>	<input type="checkbox"/>	<input type="checkbox"/>	<input type="checkbox"/>	<input type="checkbox"/>	<input type="checkbox"/>	74
	<input checked="" type="checkbox"/>	<input checked="" type="checkbox"/>	<input type="checkbox"/>	<input checked="" type="checkbox"/>	<input checked="" type="checkbox"/>	<input checked="" type="checkbox"/>	<input checked="" type="checkbox"/>	<input checked="" type="checkbox"/>	<input type="checkbox"/>	<input checked="" type="checkbox"/>	<input checked="" type="checkbox"/>	<input checked="" type="checkbox"/>	<input checked="" type="checkbox"/>	<input checked="" type="checkbox"/>	<input checked="" type="checkbox"/>	<input type="checkbox"/>	<input type="checkbox"/>	<input type="checkbox"/>	<input type="checkbox"/>	<input type="checkbox"/>	<input type="checkbox"/>	<input type="checkbox"/>	<input type="checkbox"/>	<input type="checkbox"/>	<input type="checkbox"/>	<input type="checkbox"/>	<input type="checkbox"/>	<input type="checkbox"/>	<input type="checkbox"/>	<input type="checkbox"/>	<input type="checkbox"/>	<input type="checkbox"/>	74
	<input checked="" type="checkbox"/>	<input checked="" type="checkbox"/>	<input type="checkbox"/>	<input checked="" type="checkbox"/>	<input checked="" type="checkbox"/>	<input checked="" type="checkbox"/>	<input checked="" type="checkbox"/>	<input checked="" type="checkbox"/>	<input type="checkbox"/>	<input checked="" type="checkbox"/>	<input checked="" type="checkbox"/>	<input checked="" type="checkbox"/>	<input checked="" type="checkbox"/>	<input checked="" type="checkbox"/>	<input checked="" type="checkbox"/>	<input type="checkbox"/>	<input type="checkbox"/>	<input type="checkbox"/>	<input type="checkbox"/>	<input type="checkbox"/>	<input type="checkbox"/>	<input type="checkbox"/>	<input type="checkbox"/>	<input type="checkbox"/>	<input type="checkbox"/>	<input type="checkbox"/>	<input type="checkbox"/>	<input type="checkbox"/>	<input type="checkbox"/>	<input type="checkbox"/>	<input type="checkbox"/>	<input type="checkbox"/>	74
	<input checked="" type="checkbox"/>	<input checked="" type="checkbox"/>	<input checked="" type="checkbox"/>	<input checked="" type="checkbox"/>	<input checked="" type="checkbox"/>	<input checked="" type="checkbox"/>	<input checked="" type="checkbox"/>	<input checked="" type="checkbox"/>	<input checked="" type="checkbox"/>	<input checked="" type="checkbox"/>	<input checked="" type="checkbox"/>	<input checked="" type="checkbox"/>	<input checked="" type="checkbox"/>	<input checked="" type="checkbox"/>	<input checked="" type="checkbox"/>	<input checked="" type="checkbox"/>	<input checked="" type="checkbox"/>	<input checked="" type="checkbox"/>	<input checked="" type="checkbox"/>	<input checked="" type="checkbox"/>	<input checked="" type="checkbox"/>	<input checked="" type="checkbox"/>	<input checked="" type="checkbox"/>	<input checked="" type="checkbox"/>	<input checked="" type="checkbox"/>	<input checked="" type="checkbox"/>	<input checked="" type="checkbox"/>	<input checked="" type="checkbox"/>	<input checked="" type="checkbox"/>	<input checked="" type="checkbox"/>	<input checked="" type="checkbox"/>	<input checked="" type="checkbox"/>	75
	<input checked="" type="checkbox"/>	<input checked="" type="checkbox"/>	<input type="checkbox"/>	<input checked="" type="checkbox"/>	<input checked="" type="checkbox"/>	<input checked="" type="checkbox"/>	<input checked="" type="checkbox"/>	<input checked="" type="checkbox"/>	<input checked="" type="checkbox"/>	<input checked="" type="checkbox"/>	<input checked="" type="checkbox"/>	<input checked="" type="checkbox"/>	<input checked="" type="checkbox"/>	<input checked="" type="checkbox"/>	<input checked="" type="checkbox"/>	<input type="checkbox"/>	<input checked="" type="checkbox"/>	<input checked="" type="checkbox"/>	<input checked="" type="checkbox"/>	<input checked="" type="checkbox"/>	<input checked="" type="checkbox"/>	<input checked="" type="checkbox"/>	<input checked="" type="checkbox"/>	<input checked="" type="checkbox"/>	<input checked="" type="checkbox"/>	<input checked="" type="checkbox"/>	<input checked="" type="checkbox"/>	<input checked="" type="checkbox"/>	<input checked="" type="checkbox"/>	<input checked="" type="checkbox"/>	<input checked="" type="checkbox"/>	<input checked="" type="checkbox"/>	76
	<input checked="" type="checkbox"/>	<input checked="" type="checkbox"/>	<input type="checkbox"/>	<input checked="" type="checkbox"/>	<input checked="" type="checkbox"/>	<input checked="" type="checkbox"/>	<input type="checkbox"/>	<input checked="" type="checkbox"/>	<input type="checkbox"/>	<input checked="" type="checkbox"/>	<input checked="" type="checkbox"/>	<input type="checkbox"/>	<input checked="" type="checkbox"/>	<input checked="" type="checkbox"/>	<input checked="" type="checkbox"/>	<input type="checkbox"/>	<input checked="" type="checkbox"/>	<input checked="" type="checkbox"/>	<input checked="" type="checkbox"/>	<input checked="" type="checkbox"/>	<input checked="" type="checkbox"/>	<input checked="" type="checkbox"/>	<input checked="" type="checkbox"/>	<input checked="" type="checkbox"/>	<input checked="" type="checkbox"/>	<input checked="" type="checkbox"/>	<input checked="" type="checkbox"/>	<input checked="" type="checkbox"/>	<input checked="" type="checkbox"/>	<input checked="" type="checkbox"/>	<input checked="" type="checkbox"/>	<input checked="" type="checkbox"/>	78
	<input checked="" type="checkbox"/>	<input checked="" type="checkbox"/>	<input type="checkbox"/>	<input checked="" type="checkbox"/>	<input checked="" type="checkbox"/>	<input checked="" type="checkbox"/>	<input checked="" type="checkbox"/>	<input checked="" type="checkbox"/>	<input checked="" type="checkbox"/>	<input checked="" type="checkbox"/>	<input checked="" type="checkbox"/>	<input checked="" type="checkbox"/>	<input checked="" type="checkbox"/>	<input checked="" type="checkbox"/>	<input checked="" type="checkbox"/>	<input type="checkbox"/>	<input checked="" type="checkbox"/>	<input checked="" type="checkbox"/>	<input checked="" type="checkbox"/>	<input checked="" type="checkbox"/>	<input checked="" type="checkbox"/>	<input checked="" type="checkbox"/>	<input checked="" type="checkbox"/>	<input checked="" type="checkbox"/>	<input checked="" type="checkbox"/>	<input checked="" type="checkbox"/>	<input checked="" type="checkbox"/>	<input checked="" type="checkbox"/>	<input checked="" type="checkbox"/>	<input checked="" type="checkbox"/>	<input checked="" type="checkbox"/>	<input checked="" type="checkbox"/>	79
	<input checked="" type="checkbox"/>	<input checked="" type="checkbox"/>	<input type="checkbox"/>	<input checked="" type="checkbox"/>	<input checked="" type="checkbox"/>	<input checked="" type="checkbox"/>	<input checked="" type="checkbox"/>	<input checked="" type="checkbox"/>	<input checked="" type="checkbox"/>	<input checked="" type="checkbox"/>	<input checked="" type="checkbox"/>	<input checked="" type="checkbox"/>	<input checked="" type="checkbox"/>	<input checked="" type="checkbox"/>	<input checked="" type="checkbox"/>	<input type="checkbox"/>	<input checked="" type="checkbox"/>	<input checked="" type="checkbox"/>	<input checked="" type="checkbox"/>	<input checked="" type="checkbox"/>	<input checked="" type="checkbox"/>	<input checked="" type="checkbox"/>	<input checked="" type="checkbox"/>	<input checked="" type="checkbox"/>	<input checked="" type="checkbox"/>	<input checked="" type="checkbox"/>	<input checked="" type="checkbox"/>	<input checked="" type="checkbox"/>	<input checked="" type="checkbox"/>	<input checked="" type="checkbox"/>	<input checked="" type="checkbox"/>	<input checked="" type="checkbox"/>	79
	<input checked="" type="checkbox"/>	<input checked="" type="checkbox"/>	<input type="checkbox"/>	<input checked="" type="checkbox"/>	<input checked="" type="checkbox"/>	<input checked="" type="checkbox"/>	<input checked="" type="checkbox"/>	<input checked="" type="checkbox"/>	<input checked="" type="checkbox"/>	<input checked="" type="checkbox"/>	<input checked="" type="checkbox"/>	<input checked="" type="checkbox"/>	<input checked="" type="checkbox"/>	<input checked="" type="checkbox"/>	<input checked="" type="checkbox"/>	<input type="checkbox"/>	<input checked="" type="checkbox"/>	<input checked="" type="checkbox"/>	<input checked="" type="checkbox"/>	<input checked="" type="checkbox"/>	<input checked="" type="checkbox"/>	<input checked="" type="checkbox"/>	<input checked="" type="checkbox"/>	<input checked="" type="checkbox"/>	<input checked="" type="checkbox"/>	<input checked="" type="checkbox"/>	<input checked="" type="checkbox"/>	<input checked="" type="checkbox"/>	<input checked="" type="checkbox"/>	<input checked="" type="checkbox"/>	<input checked="" type="checkbox"/>	<input checked="" type="checkbox"/>	88
	<input checked="" type="checkbox"/>	<input checked="" type="checkbox"/>	<input type="checkbox"/>	<input checked="" type="checkbox"/>	<input checked="" type="checkbox"/>	<input checked="" type="checkbox"/>	<input checked="" type="checkbox"/>	<input checked="" type="checkbox"/>	<input checked="" type="checkbox"/>	<input checked="" type="checkbox"/>	<input checked="" type="checkbox"/>	<input checked="" type="checkbox"/>	<input checked="" type="checkbox"/>	<input checked="" type="checkbox"/>	<input checked="" type="checkbox"/>	<input type="checkbox"/>	<input checked="" type="checkbox"/>	<input checked="" type="checkbox"/>	<input checked="" type="checkbox"/>	<input checked="" type="checkbox"/>	<input checked="" type="checkbox"/>	<input checked="" type="checkbox"/>	<input checked="" type="checkbox"/>	<input checked="" type="checkbox"/>	<input checked="" type="checkbox"/>	<input checked="" type="checkbox"/>	<input checked="" type="checkbox"/>	<input checked="" type="checkbox"/>	<input checked="" type="checkbox"/>	<input checked="" type="checkbox"/>	<input checked="" type="checkbox"/>	<input checked="" type="checkbox"/>	89
	<input checked="" type="checkbox"/>	<input checked="" type="checkbox"/>	<input type="checkbox"/>	<input checked="" type="checkbox"/>																													

STRIPLED IP65	PROFILI THERMOPLASTIC	TERMOPLASTICO THERMOPLASTIC												ECO ECO												PLAFONE CEILING											
		1710TP	1912TP	2020TP	2612TP	38	42	43	40	39	45	44	0808	1508	1805	1813	1912	2421	3031	4817	4731	3546	5690	5634	1828	2743	2027	7336	2110	5015	4317						
PROFESSIONAL	13W	✓	✓	□	✓	✓	✓	✓	✓	✓	✓	□	□	□	✓	✓	✓	✓	✓	✓	✓	✓	✓	✓	✓	✓	✓	✓	□	✓	✓						
	8,5W	✓	✓	□	✓	✓	✓	✓	✓	✓	✓	□	□	□	✓	✓	✓	✓	✓	✓	✓	✓	✓	✓	✓	✓	✓	✓	□	✓	✓						
	16W	✓	✓	□	✓	✓	✓	✓	✓	✓	✓	□	□	□	✓	✓	✓	✓	✓	✓	✓	✓	✓	✓	✓	✓	✓	✓	□	✓	✓						
	4,9W	✓	✓	□	✓	✓	✓	✓	✓	✓	✓	□	□	□	✓	✓	✓	✓	✓	✓	✓	✓	✓	✓	✓	✓	✓	✓	□	✓	✓						
	9,9W	✓	✓	□	✓	✓	✓	✓	✓	✓	✓	□	□	□	✓	✓	✓	✓	✓	✓	✓	✓	✓	✓	✓	✓	✓	✓	□	✓	✓						
	14,9W	✓	✓	□	✓	✓	✓	✓	✓	✓	✓	□	□	□	✓	✓	✓	✓	✓	✓	✓	✓	✓	✓	✓	✓	✓	✓	□	✓	✓						
BUSINESS	6,5W	✓	✓	□	✓	✓	✓	✓	✓	✓	✓	□	□	□	✓	✓	✓	✓	✓	✓	✓	✓	✓	✓	✓	✓	✓	□	✓	✓							
	12,5W	✓	✓	□	✓	✓	✓	✓	✓	✓	✓	□	□	□	✓	✓	✓	✓	✓	✓	✓	✓	✓	✓	✓	✓	✓	□	✓	✓							
	17,5W	□	✓	□	✓	✓	✓	✓	✓	✓	✓	□	□	□	✓	✓	✓	✓	✓	✓	✓	✓	✓	✓	✓	✓	✓	□	✓	✓							
EFFICIENT	14,5W	✓	✓	□	✓	✓	✓	✓	✓	✓	✓	□	□	□	✓	✓	✓	✓	✓	□	✓	✓	✓	✓	✓	✓	✓	□	✓	✓							
	9W	□	✓	□	✓	□	✓	✓	□	✓	✓	□	□	□	✓	✓	✓	✓	✓	□	✓	✓	✓	✓	□	✓	✓	□	□	✓							
	14W	□	✓	□	✓	□	✓	✓	□	✓	✓	□	□	□	✓	✓	✓	✓	✓	□	✓	✓	✓	✓	□	✓	✓	□	□	✓							
	19,2W	□	✓	□	✓	□	✓	✓	□	✓	✓	□	□	□	✓	✓	✓	✓	✓	□	✓	✓	✓	✓	□	✓	✓	□	□	✓							
ECONOMY	9,6W	✓	✓	□	✓	✓	✓	✓	✓	✓	✓	□	□	□	✓	✓	✓	✓	✓	✓	✓	✓	✓	✓	✓	✓	✓	□	✓	✓							
	12W	✓	✓	□	✓	✓	✓	✓	✓	✓	✓	□	□	□	✓	✓	✓	✓	✓	✓	✓	✓	✓	✓	✓	✓	✓	□	✓	✓							
	17W	□	□	□	□	□	✓	✓	✓	□	✓	✓	□	□	□	✓	✓	✓	✓	□	✓	✓	✓	✓	□	✓	✓	□	□	✓							
	22W	□	□	□	□	□	✓	✓	✓	□	✓	✓	□	□	□	✓	✓	✓	✓	□	✓	✓	✓	✓	□	✓	✓	□	□	✓							
SPECIAL	11W (4mm)	✓	✓	✓	✓	✓	✓	✓	✓	✓	✓	□	✓	□	✓	✓	✓	✓	✓	✓	✓	✓	✓	✓	✓	✓	✓	□	✓	✓							
	12W (10m)	□	✓	□	✓	□	✓	✓	□	✓	✓	□	□	□	✓	✓	✓	✓	✓	□	✓	✓	✓	✓	□	✓	✓	□	□	✓							
	9,6W (48Vdc)	□	✓	□	✓	□	✓	✓	□	✓	✓	□	□	□	✓	✓	✓	✓	✓	□	✓	✓	✓	✓	□	✓	✓	□	□	✓							
	14W (COB)	✓	✓	□	✓	✓	✓	✓	✓	✓	✓	□	□	□	✓	✓	✓	✓	✓	✓	✓	✓	✓	✓	✓	✓	✓	□	✓	✓							
SCENOGRAPHIC	14,4W (TW)	□	✓	□	✓	□	✓	✓	□	✓	✓	□	□	□	✓	✓	✓	✓	✓	✓	✓	✓	✓	✓	□	✓	✓	✓	□	✓							
	14,4W (RGB)	□	✓	□	✓	□	✓	✓	□	✓	✓	□	□	□	✓	✓	✓	✓	✓	✓	✓	✓	✓	✓	□	✓	✓	✓	□	✓							
	14,4W (RGB+W)	□	✓	□	✓	□	✓	✓	□	✓	✓	□	□	□	✓	✓	✓	✓	✓	✓	✓	✓	✓	✓	□	✓	✓	✓	□	✓							

PROFILI Pag.	132	133	134	135	138	139	140	141	142	143	144	148	149	150	152	154	155	156	158	160	162	163	164	165	166	167	168	169	170	171
-----------------	-----	-----	-----	-----	-----	-----	-----	-----	-----	-----	-----	-----	-----	-----	-----	-----	-----	-----	-----	-----	-----	-----	-----	-----	-----	-----	-----	-----	-----	-----

ANGOLARE
ANGULAR

INCASSI IN BATTUTA
RECESSED DOWNLIGHT

INCASSI A RASO
FLUSH RECESSED

	D20	D40	1010	1616	2020	2115	7676	6730	1914	2612	2711	4240	6635	5814	3537	4812	5319	6212	6214	6414	8819	9819	2351	2646	3630	6137	3596	9536	4216	4219	7454	13664	STRIPLED Pag.		
	✓	✓	□	✓	□	✓	✓	✓	□	✓	✓	✓	✓	□	✓	□	✓	✓	✓	✓	✓	✓	✓	✓	✓	✓	✓	✓	✓	✓	✓	✓	✓	34	
	✓	✓	□	✓	□	✓	✓	✓	□	✓	✓	✓	✓	□	✓	□	✓	✓	✓	✓	✓	✓	✓	✓	✓	✓	✓	✓	✓	✓	✓	✓	✓	36	
	✓	✓	□	✓	□	✓	✓	✓	□	✓	✓	✓	✓	□	✓	□	✓	✓	✓	✓	✓	✓	✓	✓	✓	✓	✓	✓	✓	✓	✓	✓	✓	37	
	✓	✓	□	✓	□	✓	✓	✓	□	✓	✓	✓	✓	□	✓	□	✓	✓	✓	✓	✓	✓	✓	✓	✓	✓	✓	✓	✓	✓	✓	✓	✓	42	
	✓	✓	□	✓	□	✓	✓	✓	□	✓	✓	✓	✓	□	✓	□	✓	✓	✓	✓	✓	✓	✓	✓	✓	✓	✓	✓	✓	✓	✓	✓	✓	43	
	✓	✓	□	✓	□	✓	✓	✓	□	✓	✓	✓	✓	□	✓	□	✓	✓	✓	✓	✓	✓	✓	✓	✓	✓	✓	✓	✓	✓	✓	✓	✓	44	
	✓	✓	□	✓	□	✓	✓	✓	□	✓	✓	✓	✓	□	✓	□	✓	✓	✓	✓	✓	✓	✓	✓	✓	✓	✓	✓	✓	✓	✓	✓	✓	48	
	✓	✓	□	✓	□	✓	✓	✓	□	✓	✓	✓	✓	□	✓	□	✓	✓	✓	✓	✓	✓	✓	✓	✓	✓	✓	✓	✓	✓	✓	✓	✓	49	
	✓	✓	□	✓	□	✓	✓	✓	□	✓	✓	✓	✓	□	✓	□	✓	✓	✓	✓	✓	✓	✓	✓	✓	✓	✓	✓	✓	✓	✓	✓	✓	50	
	✓	✓	□	✓	□	✓	✓	✓	□	✓	✓	✓	✓	□	✓	□	✓	✓	✓	✓	✓	✓	✓	✓	✓	✓	✓	✓	✓	✓	✓	✓	✓	56	
	✓	✓	□	□	□	□	✓	✓	□	✓	✓	✓	✓	□	✓	□	□	✓	✓	✓	✓	✓	✓	□	□	✓	✓	✓	✓	✓	✓	✓	✓	57	
	✓	✓	□	□	□	□	✓	✓	□	✓	✓	✓	✓	□	✓	□	□	✓	✓	✓	✓	✓	✓	□	□	✓	✓	✓	✓	✓	✓	✓	✓	58	
	✓	✓	□	□	□	□	✓	✓	□	✓	✓	✓	✓	□	✓	□	□	✓	✓	✓	✓	✓	✓	□	□	✓	✓	✓	✓	✓	✓	✓	✓	59	
	✓	✓	□	✓	□	✓	✓	✓	□	✓	✓	✓	✓	□	✓	□	✓	✓	✓	✓	✓	✓	✓	✓	✓	✓	✓	✓	✓	✓	✓	✓	✓	66	
	✓	✓	□	✓	□	✓	✓	✓	□	✓	✓	✓	✓	□	✓	□	✓	✓	✓	✓	✓	✓	✓	✓	✓	✓	✓	✓	✓	✓	✓	✓	✓	67	
	✓	✓	□	□	□	□	✓	✓	□	✓	✓	✓	✓	□	✓	□	□	✓	✓	✓	✓	✓	✓	□	□	✓	✓	✓	✓	✓	✓	✓	✓	68	
	✓	✓	□	□	□	□	✓	✓	□	✓	✓	✓	✓	□	✓	□	□	✓	✓	✓	✓	✓	✓	□	□	✓	✓	✓	✓	✓	✓	✓	✓	69	
	✓	✓	□	✓	□	✓	✓	✓	□	✓	✓	✓	✓	□	✓	□	✓	✓	✓	✓	✓	✓	✓	✓	✓	✓	✓	✓	✓	✓	✓	✓	✓	75	
	✓	✓	□	□	□	□	✓	✓	□	✓	✓	✓	✓	□	✓	□	□	✓	✓	✓	✓	✓	✓	□	□	✓	✓	✓	✓	✓	✓	✓	✓	77	
	✓	✓	□	□	□	□	✓	✓	□	✓	✓	✓	✓	□	✓	□	□	✓	✓	✓	✓	✓	✓	□	□	✓	✓	✓	✓	✓	✓	✓	✓	78	
	✓	✓	□	✓	□	✓	✓	✓	□	✓	✓	✓	✓	□	✓	□	✓	✓	✓	✓	✓	✓	✓	✓	✓	✓	✓	✓	✓	✓	✓	✓	✓	79	
	✓	✓	□	□	□	□	✓	✓	□	✓	✓	✓	✓	□	✓	□	□	✓	✓	✓	✓	✓	✓	□	□	✓	✓	✓	✓	✓	✓	✓	✓	88	
	✓	✓	□	□	□	□	✓	✓	□	✓	✓	✓	✓	□	✓	□	□	✓	✓	✓	✓	✓	✓	□	□	✓	✓	✓	✓	✓	✓	✓	✓	90	
	✓	✓	□	□	□	□	✓	✓	□	✓	✓	✓	✓	□	✓	□	□	✓	✓	✓	✓	✓	✓	□	□	✓	✓	✓	✓	✓	✓	✓	✓	92	
172																																			
173																																			
176																																			
177																																			
178																																			
179																																			
180																																			
181																																			
184																																			
185																																			
186																																			
187																																			
188																																			
189																																			
190																																			
198																																			
199																																			
200																																			
201																																			
202																																			
203																																			
204																																			
206																																			
207																																			
208																																			
209																																			
210																																			
211																																			
212																																			
213																																			
214																																			
215																																			

elco
STARLIGHT

illuminazione professionale realizzata con cura artigianale

Professional lighting crafted with care





Soluzioni di illuminazione personalizzate

Customized lighting solutions

Da quasi 40 anni ci dedichiamo alla progettazione e produzione su misura dei prodotti di illuminazione. La nostra forza è creare soluzioni personalizzate per ogni richiesta specifica.

Siamo il vostro partner affidabile per trasformare gli spazi in luoghi straordinari.

For almost 40 years, we have been dedicated to the custom design and production of lighting products. Our strength lies in creating personalized solutions for each specific request.

We are your reliable partner in transforming spaces into extraordinary places.

Il punto di riferimento per le soluzioni a LED



The benchmark for LED solutions

Nata nel 1984, Elcom è una realtà dinamica, che sin da subito si afferma sul mercato dell'illuminazione per interni ed esterni con soluzioni studiate per i professionisti dell'architettura. Negli anni l'azienda si specializza nella tecnologia a LED, rivolgendosi al mercato professionale con una vasta gamma di prodotti tecnici, in particolare i profili lineari miniaturizzati e le grandi superfici luminose.

Founded in 1984, Elcom is a dynamic reality, which immediately established itself on the market of indoor and outdoor lighting with solutions designed for architecture professionals. Over the years the company has specialized in LED technology, addressing the professional market with a wide range of technical products, in particular miniature linear profiles and large light surfaces.





Il nuovo futuro

The new future

Dal 2021 facciamo parte di Starlight Group, un'unione di aziende italiane specializzate nell'illuminazione. Insieme, offriamo soluzioni integrate su misura, controllo wireless, gestione completa del progetto e design per soddisfare ogni esigenza illuminotecnica. I valori di Starlight Group si riflettono in ogni progetto, guidando le attività dei singoli brand.

Since 2021, we have been part of Starlight Group, a union of Italian companies specialized in lighting. Together, we offer customized integrated solutions, wireless control, comprehensive project management, and design to meet every lighting requirement. The values of Starlight Group are reflected in every project, guiding the activities of our brands.

STARLIGHT

light in your hands

IVELA

elcom

ZETAQLAB

IALUX

O. CREATIONS

Affidabilità e qualità



Reliability and quality

L'esperienza decennale dell'ufficio tecnico Elcom nella progettazione di circuiti LED e di prodotti luce ad alto contenuto tecnologico è garanzia della loro qualità e affidabilità. Strip LED, profili flessibili a NEON, faretto, controller, alimentatori e molto altro. Il focus di Elcom è trovare soluzioni sempre nuove adatte a tutte le esigenze.

The ten-year experience of the Elcom technical office in the design of LED circuits and hightech light products is a guarantee of their quality and reliability. LED strips, flexible NEON profiles, spotlights, controllers, power supplies and much more. The focus of Elcom is to find always new solutions suitable for all needs.



INNOVAZIONE

Innovation

Il comparto Ricerca & Sviluppo di Elcom si occupa di progettare nuove tecnologie per creare prodotti all'avanguardia, ottimizzando al contempo i processi produttivi.

Elcom's Research & Development department designs new technologies to create innovative products, while optimizing production processes.



PERSONALIZZAZIONE

Customization

Elcom è in grado di adattare ogni prodotto alle necessità del cliente, alla tipologia dello spazio in cui sarà inserito, all'atmosfera che si desidera creare per dar vita ad un'autentica "esperienza luminosa".

Elcom is able to adapt each product to the needs of the customer, the type of space in which it will be placed, the atmosphere that you want to create to create an authentic "experience of light".



PERFORMANCE

L'azienda è in grado di offrire al cliente prodotti con un'altissimo Indice di Resa Cromatica (CRI). Ogni prodotto, infatti, riesce a far risaltare il colore reale degli oggetti illuminati in modo ineguagliabile.

The company is able to offer the customer products with a very high Color Rendering Index (CRI). Each product, in fact, manages to bring out the real color of the illuminated objects in an incomparable way.



SOSTENIBILITÀ

Sustainability

Design ecosostenibile, dalla A alla Z. Elcom utilizza componenti e materiali privi di piombo e s'impegna ogni anno a migliorare la classe energetica dei propri prodotti, creando LED che consumano sempre meno.

Eco-friendly design, from A to Z. Elcom uses lead-free components and materials and is committed every year to improving the energy class of its products with always better performing LEDs.



ASSISTENZA

Assistance

La creazione di un'esperienza d'acquisto positiva, la soddisfazione del cliente e la sua fidelizzazione sono alla base della politica di assistenza alla clientela di Elcom.

Positive purchase experience, customer satisfaction and loyalty are the main focus of Elcom's customer policy.



MADE IN ITALY

Le soluzioni di illuminazione Elcom sono progettate in Italia dai nostri designer e riflettono il gusto e il saper fare italiano.

Elcom lighting solutions are designed, in Italy by our experienced designers and reflect the Italian taste and know-how.

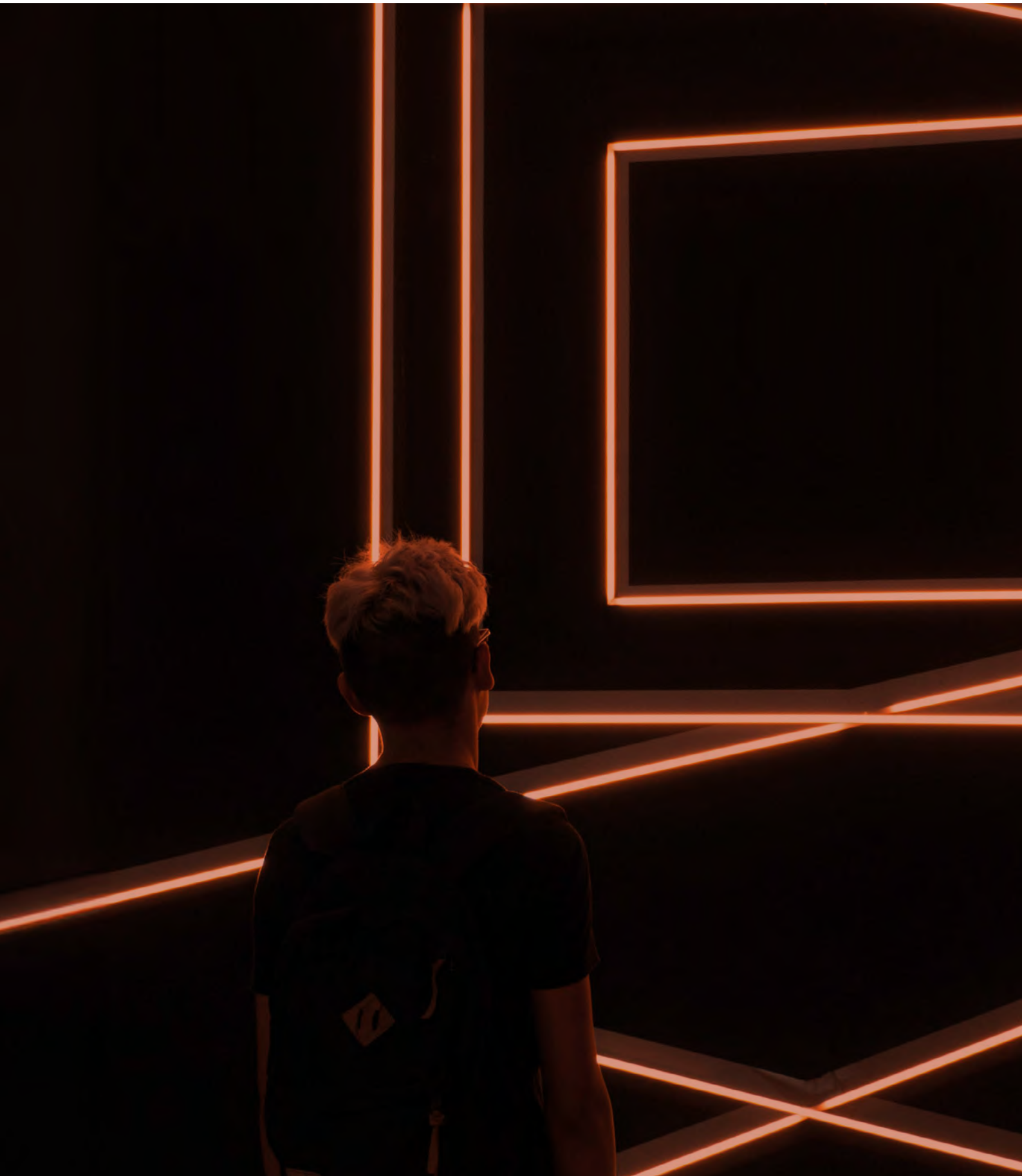

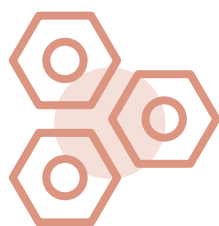

Tecnologie

Technologies

Investiamo costantemente in tecnologie e macchinari all'avanguardia per garantire un processo di produzione efficiente e di alta precisione. L'attenzione ai dettagli e l'uso di tecnologie avanzate ci permettono di mantenere gli standard più elevati durante tutto il processo produttivo, assicurando che i nostri prodotti siano realizzati con la massima cura e precisione.

We constantly invest in cutting-edge technologies and machinery to ensure an efficient and high-precision production process. Attention to detail and the use of advanced technologies enable us to maintain the highest standards throughout the manufacturing process, ensuring that our products are crafted with utmost care and precision.

Non solo StripLED

Not only LED strip lights

Leader nella produzione di StripLED, Elcom ha implementato negli anni il proprio know-how intorno a questa speciale tecnologia, creando decine di soluzioni all'avanguardia e adatte ad ogni esigenza e applicazione.

Dalle linee professional e business fino a quelle scenografiche con effetti di luce dinamici e colorati, fino ai profili a neon flessibili, ai faretto a LED, all'illuminazione da esterno calpestabile.

Leader in the production of StripLED, Elcom has implemented over the years its know-how around this special technology, creating dozens of innovative solutions suitable for every need and application.

From professional and business lines to scenic lines with dynamic and colorful light effects, up to flexible neon profiles, LED spotlights, outdoor walk-over lightings.





La tecnologia Elcom include i sistemi di controllo e gestione dell'illuminazione, dai telecomandi alle soluzioni dimmer, oltre a un'ampia gamma di accessori complementari e apparecchi per l'illuminazione di spazi indoor e outdoor.

Elcom technology includes lighting control and management systems, from remote controls to dimmer solutions, as well as a wide range of complementary accessories and luminaires for indoor and outdoor applications.



Prodotti

Products





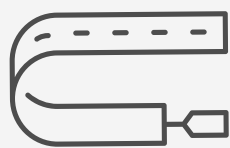

Strip LED

LED strips

Questa innovativa soluzione luminosa consente di creare una vasta gamma di esperienze d'illuminazione, offrendo versatilità e flessibilità nella progettazione degli ambienti. Le stripLED sono ideali per mettere in risalto specifiche aree di una stanza, come nicchie o punti focali, creando un'illuminazione accattivante e personalizzata. Inoltre, sono in grado di creare atmosfere intime e suggestive, contribuendo a creare l'ambiente desiderato.

Possibilità di customizzazione su richiesta fino a 25mt. Contatta il nostro servizio clienti.

This innovative lighting solution allows to create a wide range of lighting experiences, offering versatility and flexibility in space design. StripLEDs are ideal for highlighting specific areas of a room, such as niches or focal points, creating captivating and personalized atmospheres.

**Custom service on demand up to 25mt.
Please contact our Customer Care Dept.**

Linee di luce

Lines of light

Grazie al loro design flessibile e autoadesivo, possono essere posizionate con facilità su superfici piane o curve. Ciò rende il processo di installazione rapido e conveniente, permettendo agli utenti finali di ottenere un risultato di illuminazione eccezionale senza la necessità di interventi complessi.

Thanks to their flexible and self-adhesive design, they can be easily positioned on flat or curved surfaces. This makes the installation process quick and convenient, allowing end-users to achieve exceptional lighting results without the need for complex interventions.





Le stripLED sono disponibili in diverse forme, dimensioni, potenze e colori, offrendo molteplici opzioni di personalizzazione. Ciò consente di adattare le stripLED a diverse applicazioni e progetti, sia per ambienti residenziali che commerciali. Inoltre, molte stripLED possono essere controllate da remoto tramite app dedicate o dispositivi smart consentendo un controllo comodo e intuitivo dell'illuminazione.



LED strips are available in various shapes, sizes, power options, and colors, offering multiple customization choices to meet different residential and commercial demands for specific applications and projects. Additionally, many LED strips can be remotely controlled through dedicated apps or smart devices enabling convenient and intuitive lighting control.

StripLED / StripLED

Index

1. Professional Line

	Pag.
STRIPILED 154 LED/m 13W/m	34
STRIPILED 154 LED/m 26W/m	35
STRIPILED 196 LED/m 8,5W/m	36
STRIPILED 196 LED/m 16W/m	37
STRIPILED 196 LED/m 24,5W/m	38
CORNER LINE 196LED/m	40
STRIPILED 96 LED/m 4,9W/m	42
STRIPILED 96 LED/m 9,9W/m	43
STRIPILED 96 LED/m 14,9W/m	44
STRIPILED 96 LED/m 19,9W/m	45

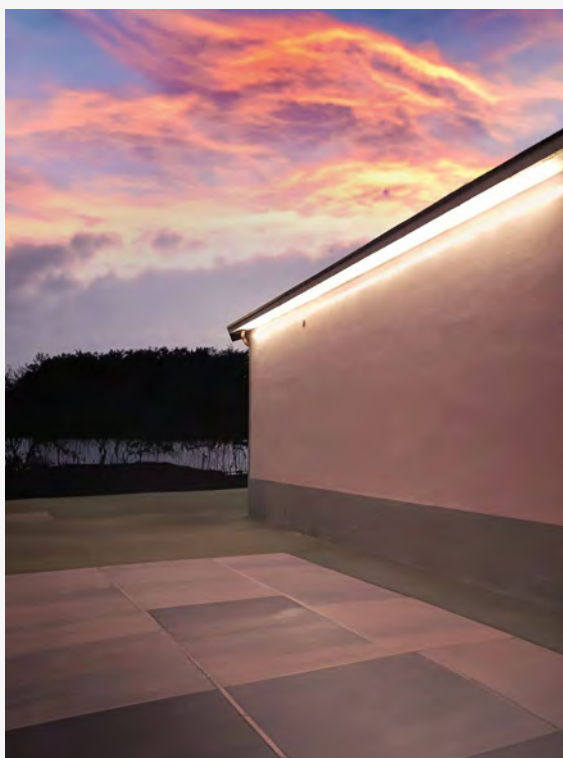

2. Business Line

	Pag.
STRIPILED 133 LED/m 6,5W/m	48
STRIPILED 140 LED/m 12,5W/m	49
STRIPILED 204 LED/m 17,5W/m	50
STRIPILED 204 LED/m 20,5W/m	51
STRIPILED 210 LED/m 35W/m	52

3. Efficient Line

	Pag.
STRIPILED 140 LED/m 14,5W/m	56
STRIPILED 210 LED/m 9W/m	57
STRIPILED 210 LED/m 14W/m	58
STRIPILED 210 LED/m 19,2W/m	59
STRIPILED 210 LED/m 22W/m	60
CORNER LINE 210LED/m	62

4. Economy Line

	Pag.
STRIPILED 120 LED/m 9,6W/m	66
STRIPILED 120 LED/m 12W/m	67
STRIPILED 180 LED/m 17W/m	68
STRIPILED 240 LED/m 22W/m	69



5. Special Line

	Pag.
STRIPILED 210 LED/m 3 IN 1	74
STRIPILED 180 LED/m 11W/m MICRO	75
STRIPILED 120 LED/m 12W/m IP20	76
STRIPILED 120 LED/m 12W/m IP65	77
STRIPILED 150 LED/m 9,6W/m 48Vdc	78
STRIPILED COB 14W/m e 18W/m	79
STRIPILED 140 LED/m 5W/m ETL	80
STRIPILED 210 LED/m 14,4W ETL	81
STRIPILED 60LED/m 4,8W ZIG-ZAG	82

6. Scenographic Line

	Pag.
STRIPILED 60+60 LED/m 14,4W/m	88
STRIPILED 120+120 LED/m 19,2W/m	89
STRIPILED 60 LED/m 14,4W/m	90
STRIPILED 120 LED/m 21W/m	91
STRIPILED 60 LED/m 14,4W/m	92
STRIPILED 140 LED/m 28,8W/m	93
STRIPILED 120 LED/m 24W/m	94
STRIPILED 60 LED/m 10,5W/m	95
STRIPILED 240 LED/m 20W/m	96
STRIPILED DIGITALE 60LED/m 7,8W	98
STRIPILED DIGITALE RGB+W PIXEL	99

7. Food

STRIPILED 112 LED/m 16,8W/m

Pag.

102

8. 220Vac

STRIPILED 120 LED/m 18W

Pag.

106

INDICE STRIP LED / INDEX STRIP LED

Su richiesta personalizzazione StripLED a 360°
On request customization StripLED to 360°

LUMEN
REAL

Guida alla scelta della Strip LED:
Scegli i lumen di cui necessiti e verifica la Strip
che soddisfa la tua richiesta

LED Strip Selection Guide:
Choose the lumens you need and check the Strip
that meets your request

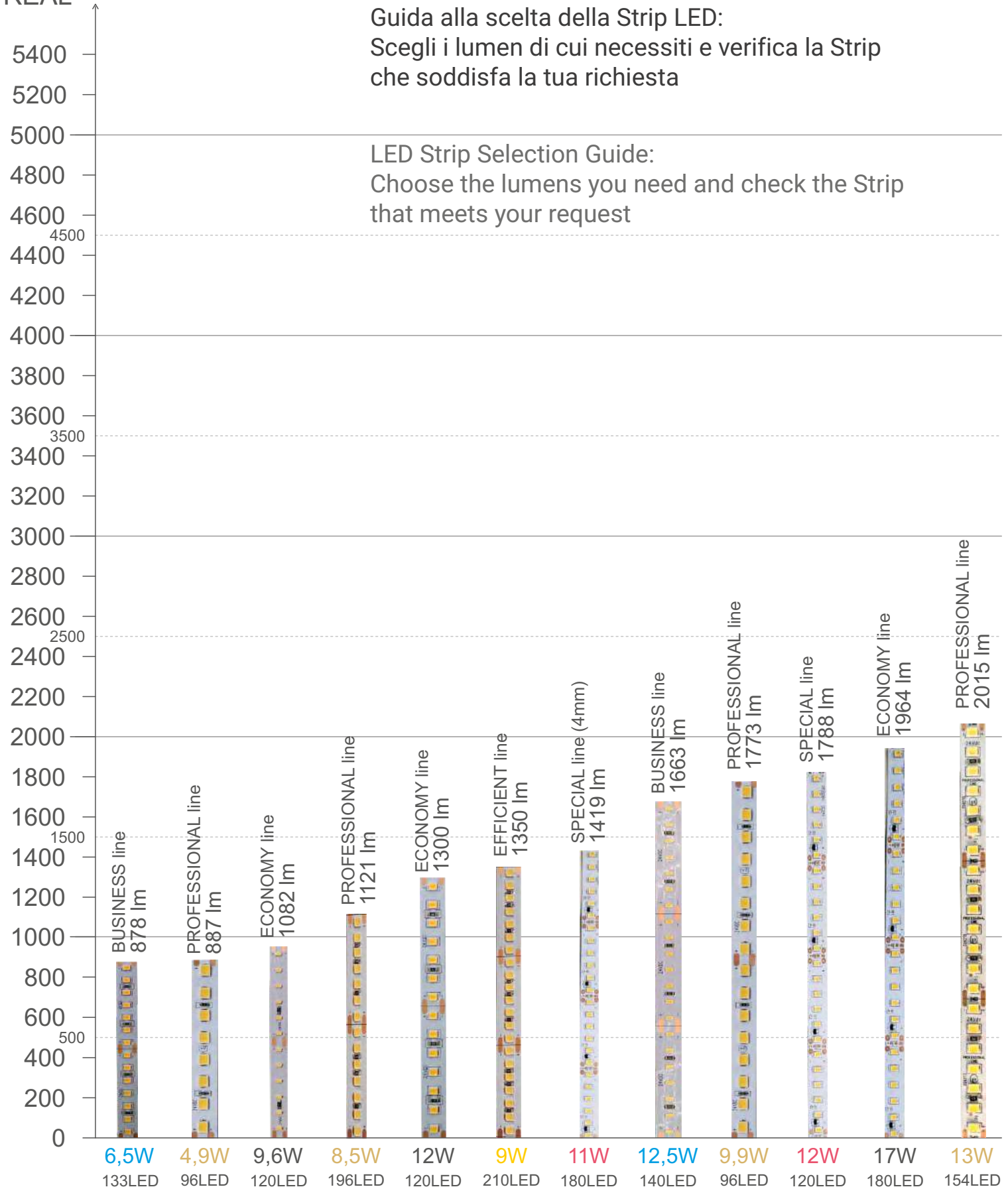

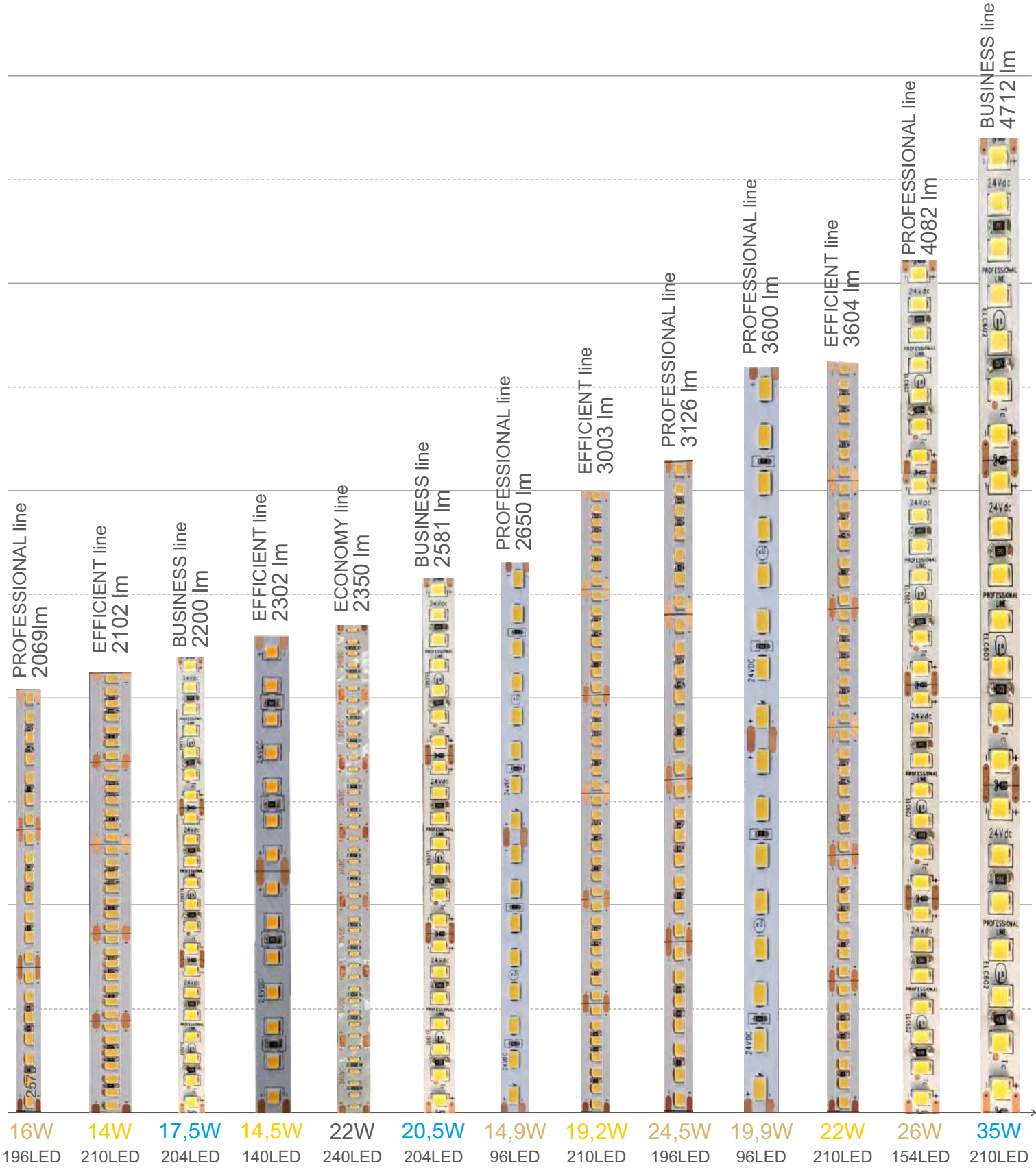

Professional, il TOP di gamma

PROFESSIONAL
LINE



Professional, top of the line

Le StripLED Professional rappresentano la scelta migliore in termini di prestazioni, efficienza e qualità della luce.

Sono la risposta ideale ad ogni progetto che richieda risultati top!

The Professional StripLED represent the best choice in terms of performance, efficiency, and light quality.

They are the ideal answer to any project that requires top-notch results!





Caratteristiche Features

- Elevata efficienza luminosa
Great lighting efficiency
- Lunga durata
Durability
- Qualità della luce
Quality of the light
- Colore uniforme
Uniform colours



Indice di resa cromatica Colour Rendering Index

Elevato CRI>93 per una resa cromatica brillante e nitida in ogni contesto.

High CRI>93 for a brilliant and clear colour rendering in every setting.



Applicazioni Applications

- Musei
Museums
- Esibizioni
Exhibitions
- Retail



Temperatura colore CCT

Le stripled Professional coprono una vasta gamma di temperature colore:
2700K / 3000K / 4000K / 5000K / 5800K

The Professional LED Strips cover a wide range of colour temperatures:
2700K / 3000K / 4000K / 5000K / 5800K



Emissione di luce Light emission

Ideali sia per luce diretta che per luce indiretta (cove lighting)

Ideal both for Direct and Indirect light (cove lighting)



Customizzazione Customization

Le nostre StripLED possono essere customizzate su specifica richiesta. Contatta il nostro servizio clienti.

Our StripLED can be customized under specifications. Our customer service can support you.

STRIPILED 154LED/m 13W/m



Scheda tecnica
Datasheet

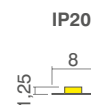
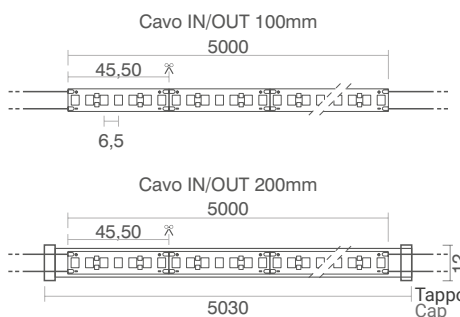

24 Vdc

IP20

IP65

5m



45,50 mm

SEZIONABILITÀ/CUT

misure in mm / measurements in mm

STUDIATE PER APPLICAZIONI IN LUCE DIRETTA
DESIGNED FOR DIRECT LIGHT APPLICATIONS



CODICE: **CODICE:** **CCT (K)** **W/m** **Flusso luminoso/m reale (lm):** **Classe energetica:**
CODE: CODE: Luminous flux/m real (lm): Energy rating:

IP20 IP65

06457	06479	2700	13	1796	E A
06458	06484	3000	13	1863	E A
06459	06485	4000	13	1981	D A
06467	06486	5800	13	2015	D A

CRI:
Ra>93/R9>50

Durata utile:
Useful lifespan:
L70 B50 = 60.000h

Tolleranza cromatica:
Tolerance chromatic:
3 SDCM

CONTROLLER COMPATIBILI:
COMPATIBLE CONTROLLER:

CODICE:	DESCRIZIONE:	PAGINA:
CODE:	DESCRIPTION:	PAGE:
09369	DALI2-PUSH-0/1.10V 24V max.11A	446
ZQ20-04R0	Z-DIM Wireless single channel 24Vdc max.11A control via push button	472

ALIMENTATORI SUGGERITI PER 5 E 10m:
SUGGESTED POWER SUPPLIES FOR 5 AND 10m:

CODICE:	DESCRIZIONE:	PAGINA:
CODE:	DESCRIPTION:	PAGE:
AL00255	DRIVER 24V 75W CLASSE II IP20 (5m)	426
07145	DRIVER 24V 150W CLASSE II IP20 (10m)	426

N.B. Per una scelta più ampia vedere il capitolo "Alimentatori" da pag.425
N.B. For a wider choice, see the chapter "Power supplies" from page 425

STRIPLLED 154LED/m 26W/m



Scheda tecnica
Datasheet

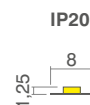
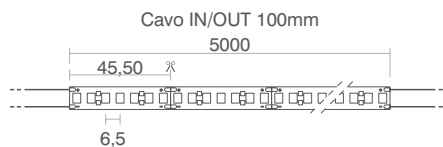

24 Vdc

IP20

5m



45,50 mm

SEZIONABILITÀ/CUT

misure in mm / measurements in mm

STUDIATE PER APPLICAZIONI IN LUCE DIRETTA

DESIGNED FOR DIRECT LIGHT APPLICATIONS



CODICE: **CCT (K)** **W/m** **Flusso luminoso/m reale (lm):** **Classe energetica:**
CODE: DESCRIPTION: Luminous flux/m real (lm): Energy rating:

IP20

06487	2700	26	3642	
06488	3000	26	3760	
06489	4000	26	4014	
06493	5800	26	4082	

CRI:
Ra>93/R9>50

Durata utile:
Useful lifespan:
L70 B50 = 60.000h

Tolleranza cromatica:
Tolerance chromatic:
3 SDCM

CONTROLLER COMPATIBILI: COMPATIBLE CONTROLLER:

CODICE: CODE:	DESCRIZIONE: DESCRIPTION:	PAGINA: PAGE:
09369	DALI2-PUSH-0/1.10V 24V max.11A	446
ZQ20-04R0	Z-DIM Wireless single channel 24Vdc max.11A control via push button	472

ALIMENTATORI SUGGERITI PER 5 E 10m: SUGGESTED POWER SUPPLIES FOR 5 AND 10m:

CODICE: CODE:	DESCRIZIONE: DESCRIPTION:	PAGINA: PAGE:
07145	DRIVER 24V 150W CLASSE II IP20 (5m)	426
AL00251	DRIVER 24V 320W CLASSE II IP20 (10m)	426

N.B. Per una scelta più ampia vedere il capitolo "Alimentatori" da pag.425
N.B. For a wider choice, see the chapter "Power supplies" from page 425

STRIPLLED 196LED/m 8,5W/m



Scheda tecnica
Datasheet

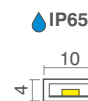
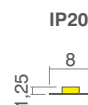
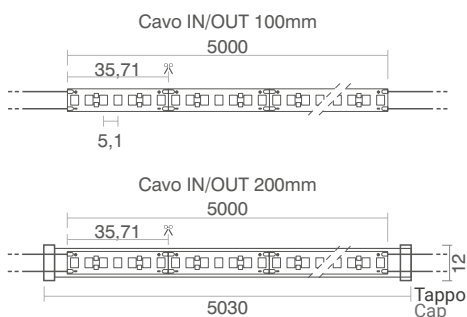

24 Vdc

IP20

IP65

5m

misure in mm / measurements in mm



35,71 mm

SEZIONABILITÀ/CUT

STUDIATE PER APPLICAZIONI IN LUCE DIRETTA
DESIGNED FOR DIRECT LIGHT APPLICATIONS

COMPATIBILE CON CORNER LINE
CORNER LINE COMPATIBLE



CODICE: **CODICE:** **CCT (K)** **W/m** **Flusso luminoso/m reale (lm):** **Classe energetica:**
CODE: CODE: Luminous flux/m real (lm): Energy rating:

CODICE:	CODICE:	CCT (K)	W/m	Flusso luminoso/m reale (lm):	Classe energetica:
CODE:	CODE:			Luminous flux/m real (lm):	Energy rating:
IP20	IP65				
05926	05946	2700	8,5	970	F
05927	05947	3000	8,5	991	F
06685	06687	3500	8,5	1078	E
05928	05948	4000	8,5	1078	E
06688	06690	5000	8,5	1121	E
05929	05949	6500	8,5	1078	E

CRI:
Ra>93

Durata utile:
Useful lifespan:
L70 B50 = 60.000h

Tolleranza cromatica:
Tolerance chromatic:
3 SDCM

CONTROLLER COMPATIBILI:
COMPATIBLE CONTROLLER:

CODICE:	DESCRIZIONE:	PAGINA:
CODE:	DESCRIPTION:	PAGE:
09369	DALI2-PUSH-0/1.10V 24V max.11A	446
ZQ20-04R0	Z-DIM Wireless single channel 24Vdc max.11A control via push button	472

ALIMENTATORI SUGGERITI PER 5 E 10m:
SUGGESTED POWER SUPPLIES FOR 5 AND 10m:

CODICE:	DESCRIZIONE:	PAGINA:
CODE:	DESCRIPTION:	PAGE:
AL00254	DRIVER 24V 60W CLASSE II IP20 (5m)	426
07260	DRIVER 24V 100W CLASSE II IP20 (10m)	426

N.B. Per una scelta più ampia vedere il capitolo "Alimentatori" da pag.425
N.B. For a wider choice, see the chapter "Power supplies" from page 425

STRIPLLED 196LED/m 16W/m



Scheda tecnica
Datasheet

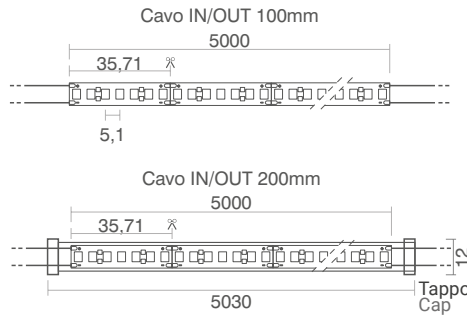

IP20



24 Vdc

IP20

IP65



IP65

5m



35,71 mm

SEZIONABILITÀ/CUT

misure in mm / measurements in mm

STUDIATE PER APPLICAZIONI IN LUCE DIRETTA
DESIGNED FOR DIRECT LIGHT APPLICATIONS

COMPATIBILE CON CORNER LINE
CORNER LINE COMPATIBLE



CODICE: CODE:	CODICE: CODE:	CCT (K)	W/m	Flusso luminoso/m reale (lm): Luminous flux/m real (lm):	Classe energetica: Energy rating:
------------------	------------------	---------	-----	---	--------------------------------------

IP20	IP65				
05978	05986	2700	16	1833	F A B
05979	05987	3000	16	1876	F A B
06694	06696	3500	16	1983	E A B
05980	05988	4000	16	2026	E A B
06697	06699	5000	16	2069	E A B
05981	05989	6500	16	2026	E A B

CRI:
Ra>93

Durata utile:
Useful lifespan:
L70 B50 = 60.000h

Tolleranza cromatica:
Tolerance chromatic:
3 SDCM

CONTROLLER COMPATIBILI: COMPATIBLE CONTROLLER:

CODICE: CODE:	DESCRIZIONE: DESCRIPTION:	PAGINA: PAGE:
09369	DALI2-PUSH-0/1.10V 24V max.11A	446
ZQ20-04R0	Z-DIM Wireless single channel 24Vdc max.11A control via push button	472

ALIMENTATORI SUGGERITI PER 5 E 10m: SUGGESTED POWER SUPPLIES FOR 5 AND 10m:

CODICE: CODE:	DESCRIZIONE: DESCRIPTION:	PAGINA: PAGE:
07260	DRIVER 24V 100W CLASSE II IP20 (5m)	426
AL00251	DRIVER 24V 180W CLASSE II IP20 (10m)	426

N.B. Per una scelta più ampia vedere il capitolo "Alimentatori" da pag.425
N.B. For a wider choice, see the chapter "Power supplies" from page 425

STRIPLLED 196LED/m 24,5W/m



Scheda tecnica
Datasheet

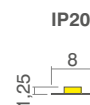
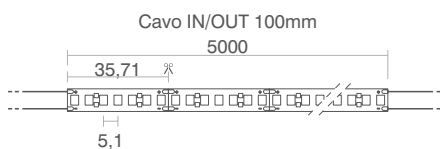

24 Vdc

IP20

5m



35,71 mm

SEZIONABILITÀ/CUT

misure in mm / measurements in mm

STUDIATE PER APPLICAZIONI IN LUCE DIRETTA
DESIGNED FOR DIRECT LIGHT APPLICATIONS

COMPATIBILE CON CORNER LINE
CORNER LINE COMPATIBLE



CODICE: **CCT (K)** **W/m** **Flusso luminoso/m reale (lm):** **Classe energetica:**
CODE: DESCRIPTION: Luminous flux/m real (lm): Energy rating:

IP20

05076	2700	24,5	2738	
05077	3000	24,5	2824	
06702	3500	24,5	2996	
05078	4000	24,5	3018	
06704	5000	24,5	3126	
05079	6500	24,5	3018	

CRI:
Ra>93

Durata utile:
Useful lifespan:
L70 B50 = 60.000h

Tolleranza cromatica:
Tolerance chromatic:
3 SDCM

CONTROLLER COMPATIBILI:
COMPATIBLE CONTROLLER:

CODICE:	DESCRIZIONE:	PAGINA:
CODE:	DESCRIPTION:	PAGE:
09369	DALI2-PUSH-0/1.10V 24V max.11A	446
ZQ20-04R0	Z-DIM Wireless single channel 24Vdc max.11A control via push button	472

ALIMENTATORI SUGGERITI PER 5 E 10m:
SUGGESTED POWER SUPPLIES FOR 5 AND 10m:

CODICE:	DESCRIZIONE:	PAGINA:
CODE:	DESCRIPTION:	PAGE:
07145	DRIVER 24V 150W CLASSE II IP20 (5m)	426
AL00251	DRIVER 24V 320W CLASSE II IP20 (10m)	426

N.B. Per una scelta più ampia vedere il capitolo "Alimentatori" da pag.425
N.B. For a wider choice, see the chapter "Power supplies" from page 425



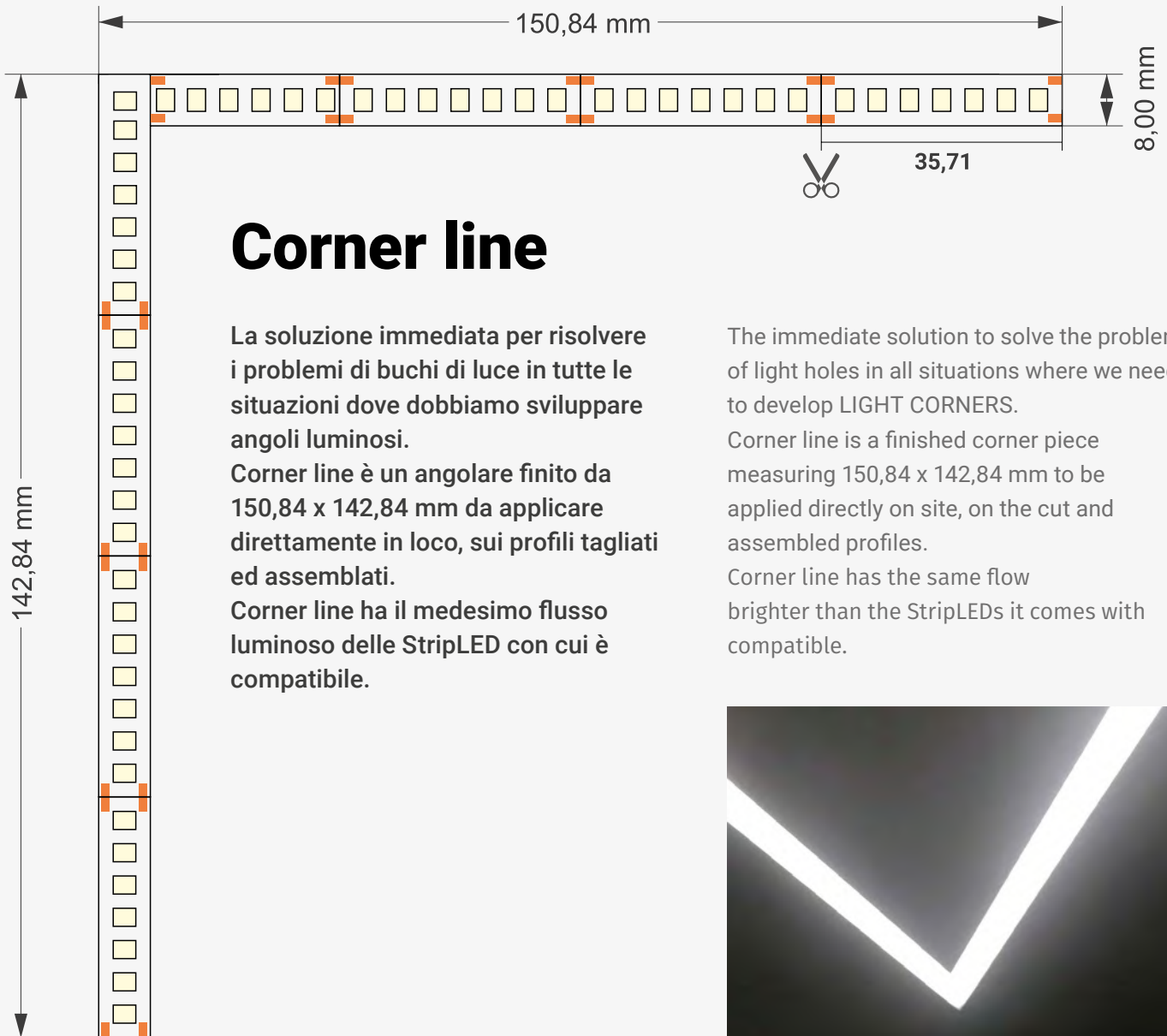

Corner line

La soluzione immediata per risolvere i problemi di buchi di luce in tutte le situazioni dove dobbiamo sviluppare angoli luminosi.

Corner line è un angolare finito da 150,84 x 142,84 mm da applicare direttamente in loco, sui profili tagliati ed assemblati.

Corner line ha il medesimo flusso luminoso delle StripLED con cui è compatibile.

The immediate solution to solve the problem of light holes in all situations where we need to develop LIGHT CORNERS.

Corner line is a finished corner piece measuring 150,84 x 142,84 mm to be applied directly on site, on the cut and assembled profiles.

Corner line has the same flow brighter than the StripLEDs it comes with compatible.



CORNER LINE 196LED/m



Scheda tecnica
Datasheet



STUDIATE PER APPLICAZIONI IN LUCE INDIRECTA
DESIGNED FOR INDIRECT LIGHT APPLICATIONS

CCT (K):	8,5 W (IP20)		16 W (IP20)		24,5 W (IP20)	
	CODICE CODE	* LM REALI REAL LM	CODICE CODE	* LM REALI REAL LM	CODICE CODE	* LM REALI REAL LM
2700	05926-COR	277	05978-COR	524	05076-COR	782
3000	05927-COR	283	05979-COR	536	05077-COR	806
3500	06685-COR	308	06694-COR	566	06702-COR	856
4000	05928-COR	308	05980-COR	578	05078-COR	862
5000	06688-COR	314	06697-COR	591	06704-COR	893
6500	05929-COR	308	05981-COR	578	05079-COR	862

CRI:
Ra>93

Durata utile:
Useful lifespan:
L70 B50 = 60.000h

Tolleranza cromatica:
Tolerance chromatic:
3 SDCM

*Flusso luminoso riferito al modulo corner line. Garantisce lo stesso flusso al m della strip di appartenenza (es. 05927-COR = strip LED 05927)

*Luminous flux refers to the corner line module. Ensures the same flow per m of the strip (es. 05927-COR = strip LED 05927)

COMPATIBILI CON:

COMPATIBLE WITH:

STRIP LED 196 LED/m 8,5 W/m

STRIP LED 196 LED/m 16 W/m

STRIP LED 196 LED/m 24,5 W/m

PAGINA:

PAGE:

36

37

38

STRIPILED 96LED/m 4,9W/m



Scheda tecnica
Datasheet



83,33 mm

SEZIONABILITÀ/CUT

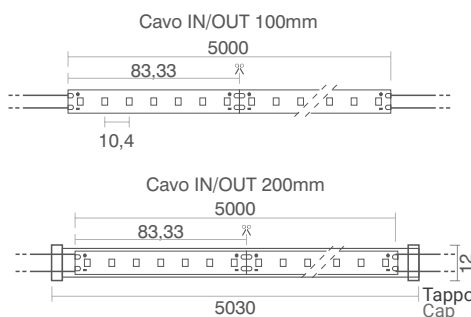

IP20



24 Vdc

IP20

IP65

5m

IP65



misure in mm / measurements in mm

STUDIATE PER APPLICAZIONI IN LUCE INDIRECTA
DESIGNED FOR INDIRECT LIGHT APPLICATIONS



CODICE: **CODICE:** **CCT (K)** **W/m** **Flusso luminoso/m reale (lm):** **Classe energetica:**
CODE: CODE: Luminous flux/m real (lm): Energy rating:

IP20 IP65

05839	05849	2700	4,9	792
05830	05836	3000	4,9	823
05832	05837	4000	4,9	876
05834	05838	5800	4,9	887



CRI:
Ra>93/R9>50

Durata utile:
Useful lifespan:
L70 B50 = 60.000h

Tolleranza cromatica:
Tolerance chromatic:
3 SDCM

CONTROLLER COMPATIBILI:
COMPATIBLE CONTROLLER:

CODICE:	DESCRIZIONE:	PAGINA:
CODE:	DESCRIPTION:	PAGE:
09369	DALI2-PUSH-0/1.10V 24V max.11A	446
ZQ20-04R0	Z-DIM Wireless single channel 24Vdc max.11A control via push button	472

ALIMENTATORI SUGGERITI PER 5 E 10m:
SUGGESTED POWER SUPPLIES FOR 5 AND 10m:

CODICE:	DESCRIZIONE:	PAGINA:
CODE:	DESCRIPTION:	PAGE:
07210	DRIVER 24V 30W CLASSE II IP20 (5m)	426
AL00254	DRIVER 24V 60W CLASSE II IP20 (10m)	426

N.B. Per una scelta più ampia vedere il capitolo "Alimentatori" da pag.425
N.B. For a wider choice, see the chapter "Power supplies" from page 425

STRIPLLED 96LED/m 9,9W/m



Scheda tecnica
Datasheet

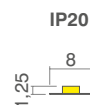
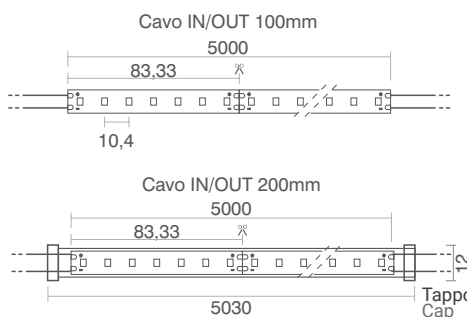

24 Vdc

IP20

IP65

5m



83,33 mm

SEZIONABILITÀ/CUT

misure in mm / measurements in mm

STUDIATE PER APPLICAZIONI IN LUCE INDIRECTA
DESIGNED FOR INDIRECT LIGHT APPLICATIONS



CODICE: **CODICE:** **CCT (K)** **W/m** **Flusso luminoso/m reale (lm):** **Classe energetica:**
CODE: CODE: Luminous flux/m real (lm): Energy rating:

IP20 IP65

05864	05865	2700	9,9	1584
05840	05846	3000	9,9	1637
05842	05847	4000	9,9	1752
05844	05848	5800	9,9	1773



CRI:
Ra>93/R9>50

Durata utile:
Useful lifespan:
L70 B50 = 60.000h

Tolleranza cromatica:
Tolerance chromatic:
3 SDCM

CONTROLLER COMPATIBILI:
COMPATIBLE CONTROLLER:

CODICE:	DESCRIZIONE:	PAGINA:
CODE:	DESCRIPTION:	PAGE:
09369	DALI2-PUSH-0/1.10V 24V max.11A	446
ZQ20-04R0	Z-DIM Wireless single channel 24Vdc max.11A control via push button	472

ALIMENTATORI SUGGERITI PER 5 E 10m:
SUGGESTED POWER SUPPLIES FOR 5 AND 10m:

CODICE:	DESCRIZIONE:	PAGINA:
CODE:	DESCRIPTION:	PAGE:
AL00254	DRIVER 24V 60W CLASSE II IP20 (5m)	426
07145	DRIVER 24V 150W CLASSE II IP20 (10m)	426

N.B. Per una scelta più ampia vedere il capitolo "Alimentatori" da pag.425
N.B. For a wider choice, see the chapter "Power supplies" from page 425

STRIPLLED 96LED/m 14,9W/m



Scheda tecnica
Datasheet



83,33 mm
SEZIONABILITÀ/CUT

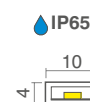
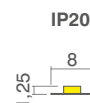
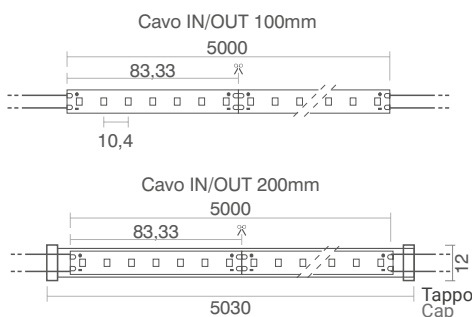

24 Vdc

IP20

IP65

5m

misure in mm / measurements in mm

STUDIATE PER APPLICAZIONI IN LUCE INDIRECTA
DESIGNED FOR INDIRECT LIGHT APPLICATIONS



CODICE: **CODICE:** **CCT (K)** **W/m** **Flusso luminoso/m reale (lm):** **Classe energetica:**
CODE: CODE: Luminous flux/m real (lm): Energy rating:

IP20 **IP65**

CODICE:	CODICE:	CCT (K)	W/m	Flusso luminoso/m reale (lm):
05859	05861	2700	14,9	2354
05850	05857	3000	14,9	2439
05852	05856	4000	14,9	2608
05854	05858	5800	14,9	2650



CRI:
Ra>93/R9>50

Durata utile:
Useful lifespan:
L70 B50 = 60.000h

Tolleranza cromatica:
Tolerance chromatic:
3 SDCM

CONTROLLER COMPATIBILI:
COMPATIBLE CONTROLLER:

CODICE:	DESCRIZIONE:	PAGINA:
09369	DALI2-PUSH-0/1.10V 24V max.11A	446
ZQ20-04R0	Z-DIM Wireless single channel 24Vdc max.11A control via push button	472

ALIMENTATORI SUGGERITI PER 5 E 10m:
SUGGESTED POWER SUPPLIES FOR 5 AND 10m:

CODICE:	DESCRIZIONE:	PAGINA:
07260	DRIVER 24V 100W CLASSE II IP20 (5m)	426
AL00253	DRIVER 24V 180W CLASSE II IP20 (10m)	426

N.B. Per una scelta più ampia vedere il capitolo "Alimentatori" da pag.425
N.B. For a wider choice, see the chapter "Power supplies" from page 425

STRIPLLED 96LED/m 19,9W/m



Scheda tecnica
Datasheet

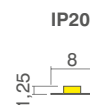
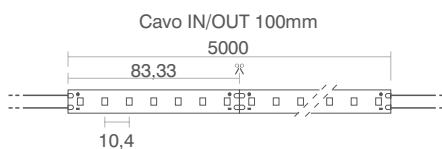

24 Vdc

IP20

5m



83,33 mm

SEZIONABILITÀ/CUT

measure in mm / measurements in mm

STUDIATE PER APPLICAZIONI IN LUCE INDIRECTA

DESIGNED FOR INDIRECT LIGHT APPLICATIONS



CODICE: **CCT (K)** **W/m** **Flusso luminoso/m reale (lm):** **Classe energetica:**
CODE: DESCRIPTION: Luminous flux/m real (lm): Energy rating:

IP20

05873	2700	19,9	3157	
05870	3000	19,9	3274	
05871	4000	19,9	3495	
05872	5800	19,9	3548	

CRI:
Ra>93/R9>50

Durata utile:
Useful lifespan:
L70 B50 = 60.000h

Tolleranza cromatica:
Tolerance chromatic:
3 SDCM

CONTROLLER COMPATIBILI:

COMPATIBLE CONTROLLER:

CODICE:	DESCRIZIONE:	PAGINA:
CODE:	DESCRIPTION:	PAGE:
09369	DALI2-PUSH-0/1.10V 24V max.11A	446
ZQ20-04R0	Z-DIM Wireless single channel 24Vdc max.11A control via push button	472

ALIMENTATORI SUGGERITI PER 5 E 10m:

SUGGESTED POWER SUPPLIES FOR 5 AND 10m:

CODICE:	DESCRIZIONE:	PAGINA:
CODE:	DESCRIPTION:	PAGE:
07145	DRIVER 24V 150W CLASSE II IP20 (5m)	426
AL00251	DRIVER 24V 320W CLASSE II IP20 (10m)	426

N.B. Per una scelta più ampia vedere il capitolo "Alimentatori" da pag.425

N.B. For a wider choice, see the chapter "Power supplies" from page 425

La nostra storia parte da qui

Our history starts from here



Business Line è la storica gamma di StripLED, che esprime il nostro DNA, la nostra evoluzione e l'innovazione alla base di questi prodotti.

Business: la StripLED per ogni esigenza!

Business Line is the longstanding range of StripLED that expresses our DNA, our evolution, and the innovation behind these products.

Business: the StripLED for every need!

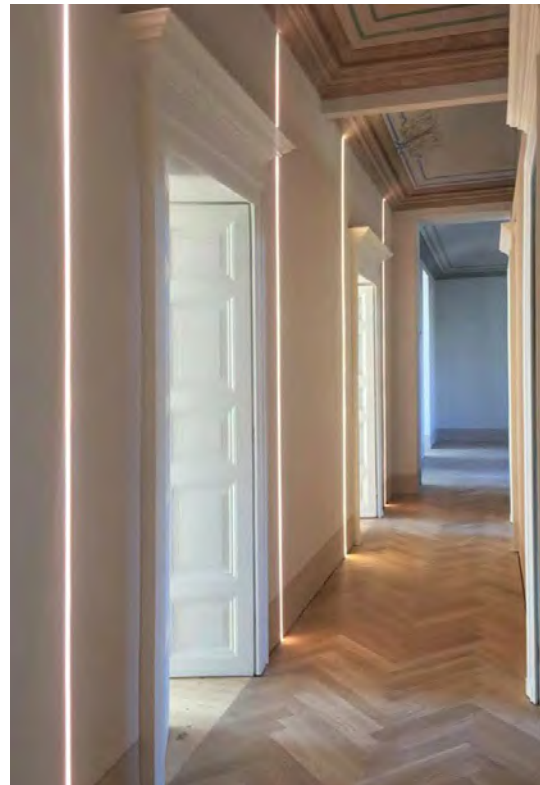



Caratteristiche Features

- **Buona efficienza luminosa**
Good lighting efficiency
- **Lunga durata**
Durability
- **Facilità di installazione**
Ease of installation
- **Versione 35W per elevati flussi luminosi**
35W version for high luminous fluxes



Indice di resa cromatica Colour Rendering Index

CRI<90 per un'ottima qualità della luce e resa del colore.

High CRI<90 for a great lighting quality and colour rendering.



Applicazioni Applications

- **Residenziale**
Residential
- **Hospitality**
- **Retail**



Emissione di luce Light emission

Ideali sia per Luce diretta che per Luce indiretta (cove lighting)

Ideal both for Direct and Indirect light (cove lighting)



Customizzazione Customization

Le nostre StripLED possono essere customizzate su specifica richiesta. Contatta il nostro servizio clienti.

Our StripLED can be customized under specifications. Our customer service can support you.

STRIPILED 133LED/m 6,5W/m



Scheda tecnica
Datasheet

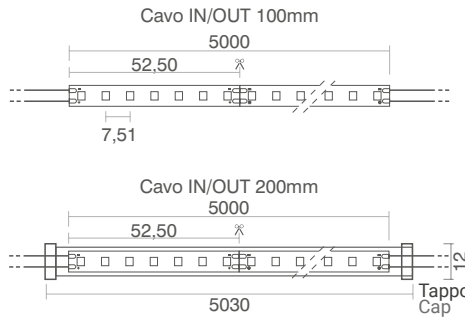

IP20



24 Vdc

IP20

IP65

5m

IP65



misure in mm / measurements in mm



52,50 mm

SEZIONABILITÀ/CUT



CODICE: **CODICE:** **CCT (K)** **W/m** **Flusso luminoso/m reale (lm):** **Classe energetica:**
CODE: CODE: Luminous flux/m real (lm): Energy rating:

IP20 IP65

CODICE:	CODICE:	CCT (K)	W/m	Flusso luminoso/m reale (lm):
CODE:	CODE:			Luminous flux/m real (lm):
05429	05434	2700	6,5	774
05430	05435	3000	6,5	790
05431	05436	4000	6,5	848
05432	05437	6500	6,5	878



CRI:
Ra>90

Durata utile:
Useful lifespan:
L70 B50 = 60.000h

Tolleranza cromatica:
Tolerance chromatic:
3 SDCM

CONTROLLER COMPATIBILI:

COMPATIBLE CONTROLLER:

CODICE:	DESCRIZIONE:	PAGINA:
CODE:	DESCRIPTION:	PAGE:
09369	DALI2-PUSH-0/1.10V 24V max.11A	446
ZQ20-04R0	Z-DIM Wireless single channel 24Vdc max.11A control via push button	472

ALIMENTATORI SUGGERITI PER 5 E 10m:

SUGGESTED POWER SUPPLIES FOR 5 AND 10m:

CODICE:	DESCRIZIONE:	PAGINA:
CODE:	DESCRIPTION:	PAGE:
AL00254	DRIVER 24V 60W CLASSE II IP20 (5m)	426
AL00255	DRIVER 24V 75W CLASSE II IP20 (10m)	426

N.B. Per una scelta più ampia vedere il capitolo "Alimentatori" da pag.425

N.B. For a wider choice, see the chapter "Power supplies" from page 425

STRIPLLED 140LED/m 12,5W/m



Scheda tecnica
Datasheet



50,00 mm
SEZIONABILITÀ/CUT

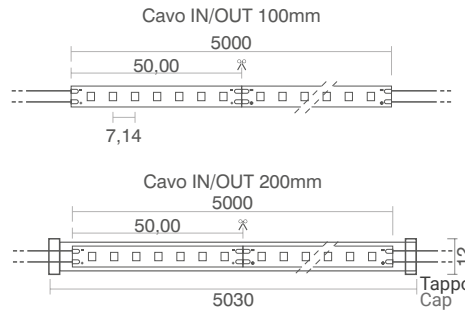

IP20



24 Vdc

IP20

IP65

5m

misure in mm / measurements in mm



CODICE: **CODICE:** **CCT (K)** **W/m** **Flusso luminoso/m reale (lm):** **Classe energetica:**
CODE: CODE: Luminous flux/m real (lm): Energy rating:

IP20 IP65

05355	05375	2700	12,5	1463
05341	05343	3000	12,5	1509
05342	05344	4000	12,5	1617
05356	05357	6500	12,5	1663



CRI:
Ra>90

Durata utile:
Useful lifespan:
L70 B50 = 60.000h

Tolleranza cromatica:
Tolerance chromatic:
3 SDCM

CONTROLLER COMPATIBILI: COMPATIBLE CONTROLLER:

CODICE: CODE:	DESCRIZIONE: DESCRIPTION:	PAGINA: PAGE:
09369	DALI2-PUSH-0/1.10V 24V max.11A	446
ZQ20-04R0	Z-DIM Wireless single channel 24Vdc max.11A control via push button	472

ALIMENTATORI SUGGERITI PER 5 E 10m: SUGGESTED POWER SUPPLIES FOR 5 AND 10m:

CODICE: CODE:	DESCRIZIONE: DESCRIPTION:	PAGINA: PAGE:
AL00255	DRIVER 24V 75W CLASSE II IP20 (5m)	426
07145	DRIVER 24V 150W CLASSE II IP20 (10m)	426

N.B. Per una scelta più ampia vedere il capitolo "Alimentatori" da pag.425
N.B. For a wider choice, see the chapter "Power supplies" from page 425

STRIPILED 204LED/m 17,5W/m



Scheda tecnica
Datasheet

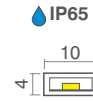
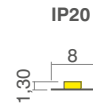
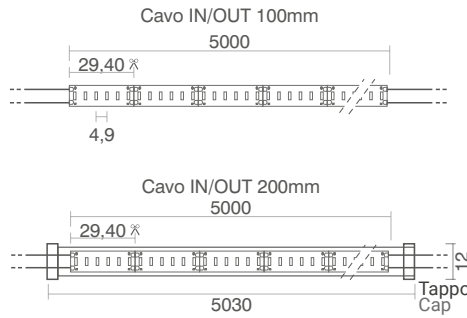

24 Vdc

IP20

IP65

5m



29,40 mm

SEZIONABILITÀ/CUT

misure in mm / measurements in mm



CODICE: **CODICE:** **CCT (K)** **W/m** **Flusso luminoso/m reale (lm):** **Classe energetica:**
CODE: CODE: Luminous flux/m real (lm): Energy rating:

IP20 IP65

05179	05398	2700	17,5	1975	
05176	05396	3000	17,5	2064	
05177	05397	4000	17,5	2200	
05178	05641	6500	17,5	2200	

CRI:
Ra>90

Durata utile:
Useful lifespan:
L70 B50 = 60.000h

Tolleranza cromatica:
Tolerance chromatic:
3 SDCM

CONTROLLER COMPATIBILI: COMPATIBLE CONTROLLER:

CODICE: CODE:	DESCRIZIONE: DESCRIPTION:	PAGINA: PAGE:
09369	DALI2-PUSH-0/1.10V 24V max.11A	446
ZQ20-04R0	Z-DIM Wireless single channel 24Vdc max.11A control via push button	472

ALIMENTATORI SUGGERITI PER 5 E 10m: SUGGESTED POWER SUPPLIES FOR 5 AND 10m:

CODICE: CODE:	DESCRIZIONE: DESCRIPTION:	PAGINA: PAGE:
AL00252	DRIVER 24V 120W CLASSE II IP20 (5m)	426
AL00251	DRIVER 24V 320W CLASSE II IP20 (10m)	426

N.B. Per una scelta più ampia vedere il capitolo "Alimentatori" da pag.425
N.B. For a wider choice, see the chapter "Power supplies" from page 425

STRIPLLED 204LED/m 20,5W/m



Scheda tecnica
Datasheet

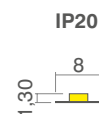
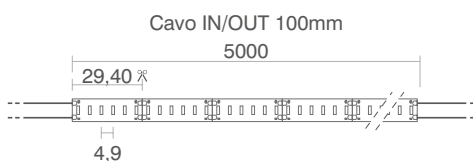

24 Vdc

IP20

5m



29,40 mm

SEZIONABILITÀ/CUT

misure in mm / measurements in mm



CODICE: **CCT (K)** **W/m** **Flusso luminoso/m reale (lm):** **Classe energetica:**
CODE: DESCRIPTION: Luminous flux/m real (lm): Energy rating:

IP20

05655	2700	20,5	2334	
05656	3000	20,5	2423	
05658	4000	20,5	2581	
05659	6500	20,5	2581	

CRI:
Ra>90

Durata utile:
Useful lifespan:
L70 B50 = 60.000h

Tolleranza cromatica:
Tolerance chromatic:
3 SDCM

CONTROLLER COMPATIBILI: COMPATIBLE CONTROLLER:

CODICE: CODE:	DESCRIZIONE: DESCRIPTION:	PAGINA: PAGE:
09369	DALI2-PUSH-0/1.10V 24V max.11A	446
ZQ20-04R0	Z-DIM Wireless single channel 24Vdc max.11A control via push button	472

ALIMENTATORI SUGGERITI PER 5 E 10m: SUGGESTED POWER SUPPLIES FOR 5 AND 10m:

CODICE: CODE:	DESCRIZIONE: DESCRIPTION:	PAGINA: PAGE:
07145	DRIVER 24V 150W CLASSE II IP20 (5m)	426
AL00251	DRIVER 24V 320W CLASSE II IP20 (10m)	426

N.B. Per una scelta più ampia vedere il capitolo "Alimentatori" da pag.425
N.B. For a wider choice, see the chapter "Power supplies" from page 425

STRIPLLED 210LED/m 35W/m



Scheda tecnica
Datasheet

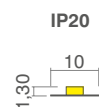
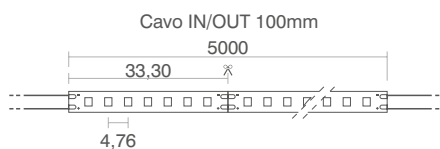

24 Vdc

IP20

5m



33,30 mm

SEZIONABILITÀ/CUT

misure in mm / measurements in mm



CODICE: CCT (K) W/m Flusso luminoso/m reale (lm): Classe energetica:
CODE: DESCRIPTION: Luminous flux/m real (lm): Energy rating:

IP20

CODICE:	CCT (K)	W/m	Flusso luminoso/m reale (lm):	Classe energetica:
05480	2700	35	4227	E A B
05481	3000	35	4435	E A B
05482	4000	35	4712	E A B
05483	6500	35	4712	E A B

CRI:
Ra>90

Durata utile:
Useful lifespan:
L70 B50 = 60.000h

Tolleranza cromatica:
Tolerance chromatic:
3 SDCM

CONTROLLER COMPATIBILI: COMPATIBLE CONTROLLER:

CODICE:	DESCRIZIONE:	PAGINA:
09369	DALI2-PUSH-0/1.10V 24V max.11A	446
ZQ20-04R0	Z-DIM Wireless single channel 24Vdc max.11A control via push button	472

ALIMENTATORI SUGGERITI PER 5 E 10m: SUGGESTED POWER SUPPLIES FOR 5 AND 10m:

CODICE:	DESCRIZIONE:	PAGINA:
AL00251	DRIVER 24V 320W CLASSE II IP20	426

N.B. Per una scelta più ampia vedere il capitolo "Alimentatori" da pag.425
N.B. For a wider choice, see the chapter "Power supplies" from page 425



Efficienza, prima di tutto



First of all, efficiency

Un nome, una certezza.

Le StripLED Efficient Line sono la miglior soluzione se si cercano prodotti con un elevato rapporto Lumen/Watt.

One name, one certainty.

The Efficient Line StripLEDs are the best solution when looking for products with a high Lumen/Watt ratio.





Caratteristiche Features

- Elevato rapporto lm/W
High lm/W ratio
- Efficienza energetica
Energy efficiency
- Brillantezza
Brightness



Indice di resa cromatica Colour Rendering Index

CRI85 per una buona qualità della luce e resa dei colori.

CRI85 for a good quality of light and colour rendering.



Applicazioni Applications

- Residenziale
Residential
- Retail



Customizzazione Customization

Le nostre StripLED possono essere customizzate su specifica richiesta. Contatta il nostro servizio clienti.

Our StripLED can be customized under specifications. Our customer service can support you.



STRIPILED 140LED/m 14,5W/m



Scheda tecnica
Datasheet

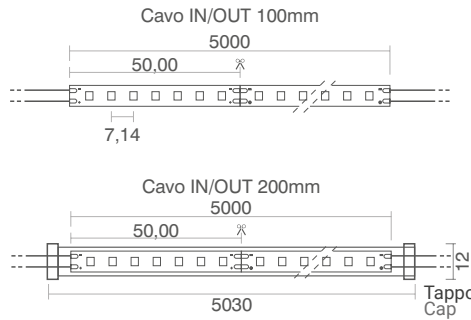

IP20



24 Vdc

IP20

IP65

5m



50,00 mm

SEZIONABILITÀ/CUT

misure in mm / measurements in mm



CODICE: **CODICE:** **CCT (K)** **W/m** **Flusso luminoso/m reale (lm):** **Classe energetica:**
CODE: CODE: Luminous flux/m real (lm): Energy rating:

IP20 IP65

06707	06736	2700	14,5	2054
06708	06737	3000	14,5	2196
06709	06738	4000	14,5	2231
06710	06739	5800	14,5	2302



CRI:
Ra>80

Durata utile:
Useful lifespan:
L70 B50 = 60.000h

Tolleranza cromatica:
Tolerance chromatic:
3 SDCM

CONTROLLER COMPATIBILI: COMPATIBLE CONTROLLER:

CODICE: CODE:	DESCRIZIONE: DESCRIPTION:	PAGINA: PAGE:
09369	DALI2-PUSH-0/1.10V 24V max.11A	446
ZQ20-04R0	Z-DIM Wireless single channel 24Vdc max.11A control via push button	472

ALIMENTATORI SUGGERITI PER 5 E 10m: SUGGESTED POWER SUPPLIES FOR 5 AND 10m:

CODICE: CODE:	DESCRIZIONE: DESCRIPTION:	PAGINA: PAGE:
07260	DRIVER 24V 100W CLASSE II IP20 (5m)	426
AL00253	DRIVER 24V 180W CLASSE II IP20 (10m)	426

N.B. Per una scelta più ampia vedere il capitolo "Alimentatori" da pag.425
N.B. For a wider choice, see the chapter "Power supplies" from page 425

STRIPLLED 210LED/m 9W/m



Scheda tecnica
Datasheet

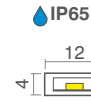
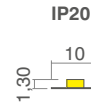
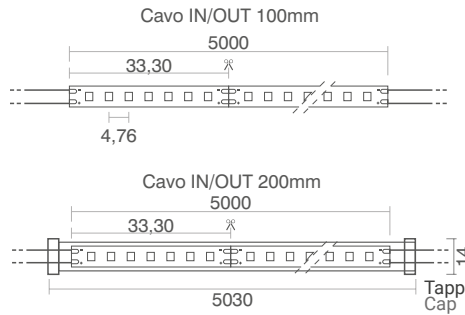
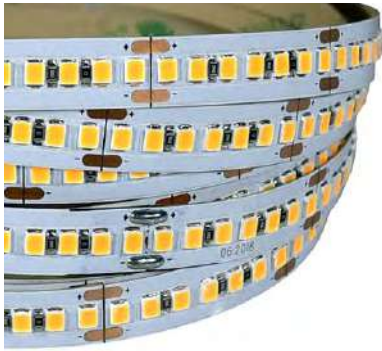

24 Vdc

IP20

IP65

5m

33,30 mm
SEZIONABILITÀ/CUT

misure in mm / measurements in mm

STUDIATE PER APPLICAZIONI IN LUCE DIRETTA
DESIGNED FOR DIRECT LIGHT APPLICATIONS

COMPATIBILE CON CORNER LINE
CORNER LINE COMPATIBLE



CODICE: **CODICE:** **CCT (K)** **W/m** **Flusso luminoso/m reale (lm):** **Classe energetica:**
CODE: CODE: Luminous flux/m real (lm): Energy rating:

IP20 **IP65**

06776	06781	2700	9	1206
06777	06782	3000	9	1288
06778	06783	4000	9	1309
06780	06784	5800	9	1351



CRI:
Ra>80

Durata utile:
Useful lifespan:
L70 B50 = 60.000h

Tolleranza cromatica:
Tolerance chromatic:
3 SDCM

CONTROLLER COMPATIBILI:

COMPATIBLE CONTROLLER:

CODICE: CODE:	DESCRIZIONE: DESCRIPTION:	PAGINA: PAGE:
09369	DALI2-PUSH-0/1.10V 24V max.11A	446
ZQ20-04R0	Z-DIM Wireless single channel 24Vdc max.11A control via push button	472

ALIMENTATORI SUGGERITI PER 5 E 10m:

SUGGESTED POWER SUPPLIES FOR 5 AND 10m:

CODICE: CODE:	DESCRIZIONE: DESCRIPTION:	PAGINA: PAGE:
AL00254	DRIVER 24V 60W CLASSE II IP20 (5m)	426
AL00252	DRIVER 24V 120W CLASSE II IP20 (10m)	426

N.B. Per una scelta più ampia vedere il capitolo "Alimentatori" da pag.425
N.B. For a wider choice, see the chapter "Power supplies" from page 425

STRIPLLED 210LED/m 14W/m



Scheda tecnica
Datasheet

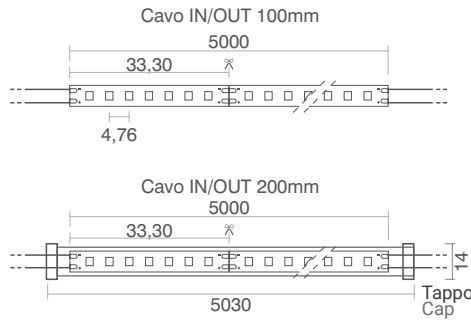

IP20



24 Vdc

IP20

IP65

5m



33,30 mm

SEZIONABILITÀ/CUT

misure in mm / measurements in mm

STUDIATE PER APPLICAZIONI IN LUCE DIRETTA
DESIGNED FOR DIRECT LIGHT APPLICATIONS

COMPATIBILE CON CORNER LINE
CORNER LINE COMPATIBLE



CODICE: **CODICE:** **CCT (K)** **W/m** **Flusso luminoso/m reale (lm):** **Classe energetica:**
CODE: CODE: Luminous flux/m real (lm): Energy rating:

IP20 IP65

06785	06789	2700	14	1876
06786	06790	3000	14	2004
06787	06791	4000	14	2037
06788	06792	5800	14	2102



CRI:
Ra>80

Durata utile:
Useful lifespan:
L70 B50 = 60.000h

Tolleranza cromatica:
Tolerance chromatic:
3 SDCM

CONTROLLER COMPATIBILI:

COMPATIBLE CONTROLLER:

CODICE:	DESCRIZIONE:	PAGINA:
CODE:	DESCRIPTION:	PAGE:
09369	DALI2-PUSH-0/1.10V 24V max.11A	446
ZQ20-04R0	Z-DIM Wireless single channel 24Vdc max.11A control via push button	472

ALIMENTATORI SUGGERITI PER 5 E 10m:

SUGGESTED POWER SUPPLIES FOR 5 AND 10m:

CODICE:	DESCRIZIONE:	PAGINA:
CODE:	DESCRIPTION:	PAGE:
07260	DRIVER 24V 100W CLASSE II IP20 (5m)	426
AL00253	DRIVER 24V 180W CLASSE II IP20 (10m)	426

N.B. Per una scelta più ampia vedere il capitolo "Alimentatori" da pag.425
N.B. For a wider choice, see the chapter "Power supplies" from page 425

STRIPILED 210LED/m 19,2W/m



Scheda tecnica
Datasheet



33,30 mm
SEZIONABILITÀ/CUT

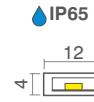
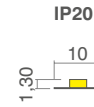
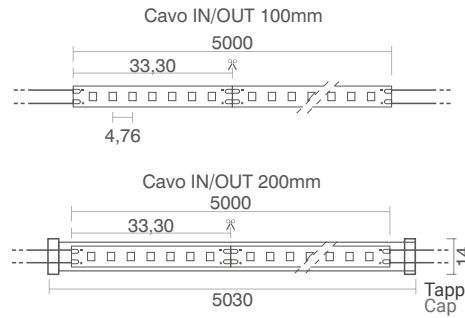

24 Vdc

IP20

IP65

5m

misure in mm / measurements in mm

STUDIATE PER APPLICAZIONI IN LUCE DIRETTA
DESIGNED FOR DIRECT LIGHT APPLICATIONS

COMPATIBILE CON CORNER LINE
CORNER LINE COMPATIBLE



CODICE: **CODICE:** **CCT (K)** **W/m** **Flusso luminoso/m reale (lm):** **Classe energetica:**
CODE: CODE: Luminous flux/m real (lm): Energy rating:

IP20 IP65

06715	06744	2700	19,2	2680	E
06716	06745	3000	19,2	2864	D
06717	06746	4000	19,2	2911	D
06718	06747	5800	19,2	3003	D

CRI:
Ra>80

Durata utile:
Useful lifespan:
L70 B50 = 60.000h

Tolleranza cromatica:
Tolerance chromatic:
3 SDCM

CONTROLLER COMPATIBILI:

COMPATIBLE CONTROLLER:

CODICE:	DESCRIZIONE:	PAGINA:
CODE:	DESCRIPTION:	PAGE:
09369	DALI2-PUSH-0/1.10V 24V max.11A	446
ZQ20-04R0	Z-DIM Wireless single channel 24Vdc max.11A control via push button	472

ALIMENTATORI SUGGERITI PER 5 E 10m:

SUGGESTED POWER SUPPLIES FOR 5 AND 10m:

CODICE:	DESCRIZIONE:	PAGINA:
CODE:	DESCRIPTION:	PAGE:
07145	DRIVER 24V 150W CLASSE II IP20 (5m)	426
AL00251	DRIVER 24V 320W CLASSE II IP20 (10m)	426

N.B. Per una scelta più ampia vedere il capitolo "Alimentatori" da pag.425
N.B. For a wider choice, see the chapter "Power supplies" from page 425

STRIPILED 210LED/m 22W/m



Scheda tecnica
Datasheet

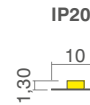
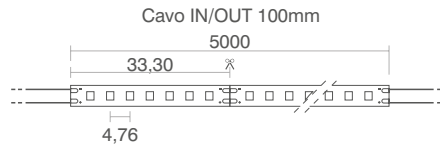

24 Vdc

IP20

5m



33,30 mm

SEZIONABILITÀ/CUT

misure in mm / measurements in mm

STUDIATE PER APPLICAZIONI IN LUCE DIRETTA
DESIGNED FOR DIRECT LIGHT APPLICATIONS

COMPATIBILE CON CORNER LINE
CORNER LINE COMPATIBLE



CODICE: **CCT (K)** **W/m** **Flusso luminoso/m reale (lm):** **Classe energetica:**
CODE: DESCRIPTION: Luminous flux/m real (lm): Energy rating:

IP20

06723	2700	22	3081	
06724	3000	22	3293	
06725	4000	22	3346	
06726	5800	22	3604	

CRI:
Ra>80

Durata utile:
Useful lifespan:
L70 B50 = 60.000h

Tolleranza cromatica:
Tolerance chromatic:
3 SDCM

CONTROLLER COMPATIBILI:
COMPATIBLE CONTROLLER:

CODICE: CODE:	DESCRIZIONE: DESCRIPTION:	PAGINA: PAGE:
09369	DALI2-PUSH-0/1.10V 24V max.11A	446
ZQ20-04R0	Z-DIM Wireless single channel 24Vdc max.11A control via push button	472

ALIMENTATORI SUGGERITI PER 5 E 10m:
SUGGESTED POWER SUPPLIES FOR 5 AND 10m:

CODICE: CODE:	DESCRIZIONE: DESCRIPTION:	PAGINA: PAGE:
07145	DRIVER 24V 150W CLASSE II IP20 (5m)	426
AL00251	DRIVER 24V 320W CLASSE II IP20 (10m)	426

N.B. Per una scelta più ampia vedere il capitolo "Alimentatori" da pag.425
N.B. For a wider choice, see the chapter "Power supplies" from page 425





Corner line

La soluzione immediata per risolvere i problemi di buchi di luce in tutte le situazioni dove dobbiamo sviluppare angoli luminosi.

Corner line è un angolare finito da 143,32 x 133,32 mm da applicare direttamente in loco, sui profili tagliati ed assemblati.

Corner line ha il medesimo flusso luminoso delle StripLED con cui è compatibile.

The immediate solution to solve the problem of light holes in all situations where we need to develop LIGHT CORNERS.

Corner line is a finished corner piece measuring 143,32 x 133,32 mm to be applied directly on site, on the cut and assembled profiles.

Corner line has the same flow brighter than the StripLEDs it comes with compatible.



CORNER LINE 210LED/m



Scheda tecnica
Datasheet



STUDIATE PER APPLICAZIONI IN LUCE INDIRECTA
DESIGNED FOR INDIRECT LIGHT APPLICATIONS

CCT (K):	9 W (IP20)		14 W (IP20)		19,2 W (IP20)		22 W (IP20)		CRI: Ra>80 Durata utile: Useful lifespan: L70 B50 = 60.000h Tolleranza cromatica: Tolerance chromatic: 3 SDCM
	CODICE CODE	LM REALI REAL LM	CODICE CODE	LM REALI REAL LM	CODICE CODE	LM REALI REAL LM	CODICE CODE	LM REALI REAL LM	
2700	06776-COR	321	06785-COR	500	06715-COR	714	06723-COR	822	
3000	06777-COR	343	06786-COR	534	06716-COR	764	06724-COR	878	
4000	06778-COR	349	06787-COR	543	06717-COR	776	06725-COR	892	
5800	06780-COR	360	06788-COR	560	06718-COR	800	06726-COR	961	

*Flusso luminoso riferito al modulo corner line. Garantisce lo stesso flusso al m della strip di appartenenza (es. 05927-COR = strip LED 05927)
*Luminous flux refers to the corner line module. Ensures the same flow per m of the strip (es. 05927-COR = strip LED 05927)

COMPATIBILI CON:
COMPATIBLE WITH:

PAGINA:
PAGE:

STRIP LED 210 LED/m 9 W/m

57

STRIP LED 210 LED/m 14 W/m

58

STRIP LED 210 LED/m 19,2 W/m

59

STRIP LED 210 LED/m 22 W/m

60

Libertà di progettazione



Freedom of lighting design

La linea di StripLED Eco è stata pensata e sviluppata per competere in un settore dove il rapporto qualità/prezzo la fa da padrone.

3 le potenze disponibili, anche in versione IP65.

The Eco line of StripLED has been specifically created to compete in a market where the balance between quality and price is crucial.

Three power options are available, including IP65 versions.





Caratteristiche Features

- Elevato rapporto lm/W
High lm/W ratio
- Efficienza energetica
Energy efficiency
- Brillantezza
Brightness



Applicazioni Applications

- Residenziale
Residential
- Retail



Customizzazione Customization

Le nostre StripLED possono essere customizzate su specifica richiesta. Contatta il nostro servizio clienti.

Our StripLED can be customized under specifications. Our customer service can support you.

STRIPLLED 120LED/m 9,6W/m



Scheda tecnica
Datasheet

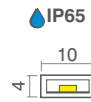
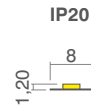
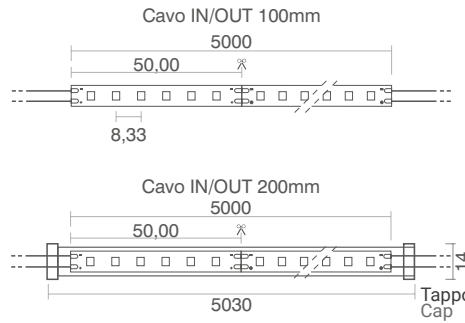

24 Vdc

IP20

IP65

5m



50,00 mm

SEZIONABILITÀ/CUT

measure in mm / measurements in mm



CODICE: **CODICE:** **CCT (K)** **W/m** **Flusso luminoso/m reale (lm):** **Classe energetica:**
CODE: CODE: Luminous flux/m real (lm): Energy rating:

IP20 IP65

05092 05117 3000 9,6 1016

05142 05118 4000 9,6 1082



CRI:
Ra>90

Durata utile:
Useful lifespan:
L70 B50 = 60.000h

Tolleranza cromatica:
Tolerance chromatic:
3 SDCM

CONTROLLER COMPATIBILI: COMPATIBLE CONTROLLER:

CODICE: CODE:	DESCRIZIONE: DESCRIPTION:	PAGINA: PAGE:
09369	DALI2-PUSH-0/1.10V 24V max.11A	446
ZQ20-04R0	Z-DIM Wireless single channel 24Vdc max.11A control via push button	472

ALIMENTATORI SUGGERITI PER 5 E 10m: SUGGESTED POWER SUPPLIES FOR 5 AND 10m:

CODICE: CODE:	DESCRIZIONE: DESCRIPTION:	PAGINA: PAGE:
AL00255	DRIVER 24V 75W CLASSE II IP20 (5m)	426
AL00252	DRIVER 24V 120W CLASSE II IP20 (10m)	426

N.B. Per una scelta più ampia vedere il capitolo "Alimentatori" da pag.425
N.B. For a wider choice, see the chapter "Power supplies" from page 425

STRIPLLED 120LED/m 12W/m



Scheda tecnica
Datasheet

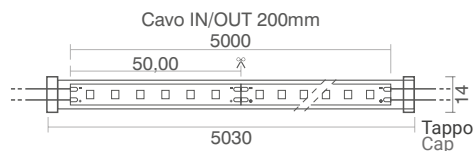
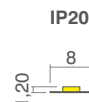
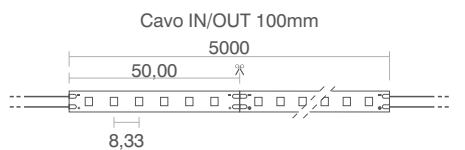

24 Vdc

IP20

IP65

5m



50,00 mm

SEZIONABILITÀ/CUT

misure in mm / measurements in mm



CODICE: **CODICE:** **CCT (K)** **W/m** **Flusso luminoso/m reale (lm):** **Classe energetica:**
CODE: CODE: Luminous flux/m real (lm): Energy rating:

IP20 IP65

06206 06236 3000 12 1200



06207 06237 4000 12 1300



CRI:
Ra>85

Durata utile:
Useful lifespan:
L70 B50 = 60.000h

Tolleranza cromatica:
Tolerance chromatic:
3 SDCM

CONTROLLER COMPATIBILI: COMPATIBLE CONTROLLER:

CODICE: CODE:	DESCRIZIONE: DESCRIPTION:	PAGINA: PAGE:
09369	DALI2-PUSH-0/1.10V 24V max.11A	446
ZQ20-04R0	Z-DIM Wireless single channel 24Vdc max.11A control via push button	472

ALIMENTATORI SUGGERITI PER 5 E 10m: SUGGESTED POWER SUPPLIES FOR 5 AND 10m:

CODICE: CODE:	DESCRIZIONE: DESCRIPTION:	PAGINA: PAGE:
AL00255	DRIVER 24V 75W CLASSE II IP20 (5m)	426
07145	DRIVER 24V 150W CLASSE II IP20 (10m)	426

N.B. Per una scelta più ampia vedere il capitolo "Alimentatori" da pag.425
N.B. For a wider choice, see the chapter "Power supplies" from page 425

STRIPLLED 180LED/m 17W/m



Scheda tecnica
Datasheet



33,33 mm

SEZIONABILITÀ/CUT

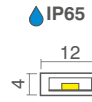
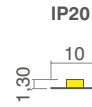
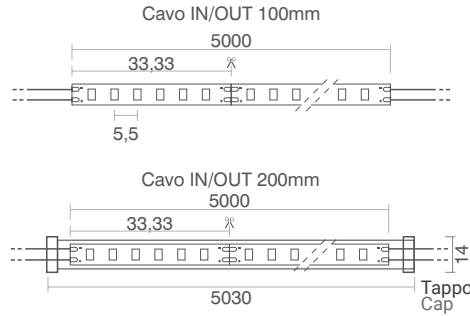

24 Vdc

IP20

IP65

5m

misure in mm / measurements in mm



CODICE: **CODICE:** **CCT (K)** **W/m** **Flusso luminoso/m reale (lm):** **Classe energetica:**
CODE: CODE: Luminous flux/m real (lm): Energy rating:

IP20 IP65

06208 06238 3000 17 1800

06209 06239 4000 17 1964



CRI:
Ra>85

Durata utile:
Useful lifespan:
L70 B50 = 60.000h

Tolleranza cromatica:
Tolerance chromatic:
3 SDCM

CONTROLLER COMPATIBILI:
COMPATIBLE CONTROLLER:

CODICE: CODE:	DESCRIZIONE: DESCRIPTION:	PAGINA: PAGE:
09369	DALI2-PUSH-0/1.10V 24V max.11A	446
ZQ20-04R0	Z-DIM Wireless single channel 24Vdc max.11A control via push button	472

ALIMENTATORI SUGGERITI PER 5 E 10m:
SUGGESTED POWER SUPPLIES FOR 5 AND 10m:

CODICE: CODE:	DESCRIZIONE: DESCRIPTION:	PAGINA: PAGE:
AL00252	DRIVER 24V 120W CLASSE II IP20 (5m)	426
AL00251	DRIVER 24V 320W CLASSE II IP20 (10m)	426

N.B. Per una scelta più ampia vedere il capitolo "Alimentatori" da pag.425
 N.B. For a wider choice, see the chapter "Power supplies" from page 425

STRIPLLED 240LED/m 22W/m



Scheda tecnica
Datasheet



25,00 mm

SEZIONABILITÀ/CUT

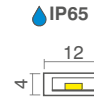
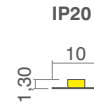
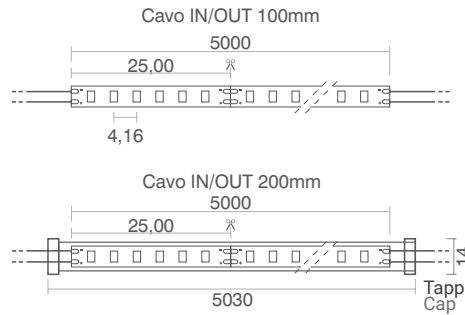

misure in mm / measurements in mm



CODICE: **CODICE:** **CCT (K)** **W/m** **Flusso luminoso/m reale (lm):** **Classe energetica:**
CODE: CODE: Luminous flux/m real (lm): Energy rating:

IP20 **IP65**

06225 **06308** | 3000 22 2315

06226 **06309** | 4000 22 2350

CRI:
Ra>85

Durata utile:
Useful lifespan:
L70 B50 = 60.000h

Tolleranza cromatica:
Tolerance chromatic:
3 SDCM

CONTROLLER COMPATIBILI:

COMPATIBLE CONTROLLER:

CODICE: CODE:	DESCRIZIONE: DESCRIPTION:	PAGINA: PAGE:
09369	DALI2-PUSH-0/1.10V 24V max.11A	446
ZQ20-04R0	Z-DIM Wireless single channel 24Vdc max.11A control via push button	472

ALIMENTATORI SUGGERITI PER 5 E 10m:

SUGGESTED POWER SUPPLIES FOR 5 AND 10m:

CODICE: CODE:	DESCRIZIONE: DESCRIPTION:	PAGINA: PAGE:
07145	DRIVER 24V 150W CLASSE II IP20 (5m)	426
AL00251	DRIVER 24V 320W CLASSE II IP20 (10m)	426

N.B. Per una scelta più ampia vedere il capitolo "Alimentatori" da pag.425

N.B. For a wider choice, see the chapter "Power supplies" from page 425

Luce speciale, per progetti speciali



A special light, for special projects

Tutte le StripLED presenti in questa categoria sono nate da richieste uniche e specifiche e hanno poi trovato uno spazio dedicato all'interno di questo catalogo. **Qui trovi le soluzioni per tutti i tuoi progetti: l'unico limite è l'immaginazione.**

All the StripLED in this category were developed based on unique and specific requests and were subsequently included in this catalog. **Here, you will find solutions for all your projects: the only limit is your imagination.**





3 in 1 Multipower

StripLED multipotenza dimmerabile meccanicamente a tre potenze diverse, in un'unica soluzione.

Mechanically dimmable multipower StripLED with three different power options, all in one solution.



48V

StripLED speciale disponibile anche in versione IP65, rialimentabile dopo 30mt senza cadute di tensione.

Special StripLED available in an IP65 version, can be re-powered after 30 meters, without voltage drops.

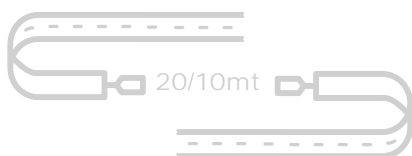

Long distance 24V

StripLED 24V disponibile in 3 temperature di colore e rialimentabile dopo 20mt (IP20) oppure 10mt (IP65).

24V StripLED available in 3 colour temperatures and can be re-powered after 20 meters (IP20) or 10mt (IP65).



Micro Strip

Ideali per l'illuminazione di spazi ridotti o per applicazioni all'interno di mobili. Larghezza 4mm, compatibili con i microprofili.

Well-suited for illuminating compact spaces or for use within furniture. 4mm width, compatible with our micro profiles.



StripLED COB

StripLED ideali per ottenere effetti di luce continua ed omogenea senza puntature a vista. Garantiscono una resa naturale dei colori e ottime prestazioni.

Ideal stripes for achieving continuous and homogeneous light effects without visible dots. They guarantee natural color rendering and excellent performance.



ETL listed

StripLED speciali con certificato di conformità adatto per il mercato nordamericano (Stati Uniti e Canada).

Special StripLED with conformity certificate suitable for the North American market (United States and Canada).

3 in 1 Multipower

Una sola stripLED, al posto di tre

Just one LEDstrips,
instead of three

Strip con 3 potenze in unica soluzione. La Strip presenta 4 cavi, 1 positivo e 3 negativi. Basta cablare uno dei 3 anodi per avere differemente: 7,5W; 14W; 20W. Il numero di LED che si accendono sarà sempre il medesimo, cambia solo la quantità di lumen ed il Wattaggio.

Strip with 3 powers in a single solution. The Strip has 4 wires, 1 positive and 3 negatives. Simply wiring one of the 3 anodes allows for different power outputs: 7.5W, 14W, 20W. The number of LEDs that light up will always be the same; only the amount of lumens and wattage changes.

Positivo +
Positive +

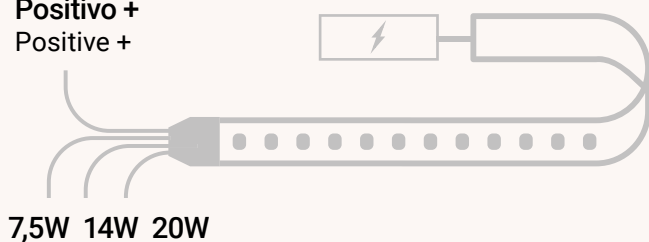

- 210 LED/m
- Ra > 90
- SDCM 3
- Ri-alimentazione 5m
Re-power 5m
- Alimentazione 24Vdc
24Vdc supply



7,5W



14W



20W



Micro Strip

Potenza racchiusa in perfezione miniaturizzata

Power encased in miniaturized perfection

Grazie alle sue dimensioni compatte, questa StripLED offre molteplici possibilità di applicazione. Può essere utilizzata per l'illuminazione di scaffali, vetrine, armadi, pensili da cucina, scrivanie e molti altri spazi ristretti che richiedono una sorgente di luce discreta ma efficace.

Thanks to its compact size, this StripLED offers multiple application possibilities. It can be used for illuminating shelves, display cases, cabinets, kitchen cupboards, desks, and many other confined spaces that require a discreet yet effective light source.

STRIPILED 210LED/m

3 IN 1 7,5/14/20W/m



Scheda tecnica
Datasheet

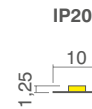
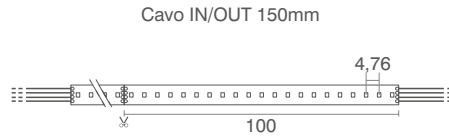

100,00 mm

SEZIONABILITÀ/CUT

misure in mm / measurements in mm

MULTIPOWER - UNICO PRODOTTO 3 POTENZE
MULTIPOWER - SINGLE PRODUCT 3 POWERS



CODICE: CCT (K) W/m Flusso luminoso/m reale (lm): Classe energetica:
CODE: DESCRIPTION: POWER: Luminous flux/m real (lm): Energy rating:

IP20

CODICE:	CCT (K)	W/m	Flusso luminoso/m reale (lm):	Classe energetica:
CODE:	DESCRIPTION:	POWER:	Luminous flux/m real (lm):	Energy rating:
06680	3000	7,5	768	
		14	1436	
		20	2228	
06681	4000	7,5	853	
		14	1406	
		20	2268	

CRI:
Ra>90

Durata utile:
Useful lifespan:
L70 B50 = 60.000h

Tolleranza cromatica:
Tolerance chromatic:
3 SDCM

CONTROLLER COMPATIBILI: COMPATIBLE CONTROLLER:

CODICE:	DESCRIZIONE:	PAGINA:
CODE:	DESCRIPTION:	PAGE:
09369	DALI2-PUSH-0/1.10V 24V max.11A	446
ZQ20-04R0	Z-DIM Wireless single channel 24Vdc max.11A control via push button	472

ALIMENTATORI SUGGERITI PER 5 E 10m: SUGGESTED POWER SUPPLIES FOR 5 AND 10m:

CODICE:	DESCRIZIONE:	PAGINA:
CODE:	DESCRIPTION:	PAGE:
07145	DRIVER 24V 150W CLASSE II IP20 (5m)	426
AL00251	DRIVER 24V 320W CLASSE II IP20 (10m)	426

N.B. Per una scelta più ampia vedere il capitolo "Alimentatori" da pag.425
N.B. For a wider choice, see the chapter "Power supplies" from page 425

STRIPILED 180LED/m 11W/m

MICRO STRIPILED 4mm



Scheda tecnica
Datasheet

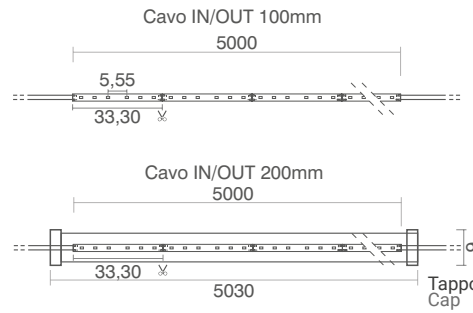

IP20



24 Vdc

IP20

IP65

5m



33,30 mm

SEZIONABILITÀ/CUT

misure in mm / measurements in mm

MICRO STRIPILED - LARGHEZZA 4mm
MICRO STRIPILED - WIDE 4mm



CODICE: **CODICE:** **CCT (K)** **W/m** **Flusso luminoso/m reale (lm):** **Classe energetica:**
CODE: CODE: Luminous flux/m real (lm): Energy rating:

CODICE:	CODICE:	CCT (K)	W/m	Flusso luminoso/m reale (lm):	Classe energetica:
CODE:	CODE:			Luminous flux/m real (lm):	Energy rating:
IP20	IP65				
05087	05263	3000	11	1361	E A G
05088	05264	4000	11	1419	E A G
05089	05269	5800	11	1419	E A G

CRI:
Ra>85

Durata utile:
Useful lifespan:
L70 B50 = 60.000h

Tolleranza cromatica:
Tolerance chromatic:
5 SDCM

CONTROLLER COMPATIBILI:

COMPATIBLE CONTROLLER:

CODICE:	DESCRIZIONE:	PAGINA:
CODE:	DESCRIPTION:	PAGE:
09369	DALI2-PUSH-0/1.10V 24V max.11A	446
ZQ20-04R0	Z-DIM Wireless single channel 24Vdc max.11A control via push button	472

ALIMENTATORI SUGGERITI PER 5 E 10m:

SUGGESTED POWER SUPPLIES FOR 5 AND 10m:

CODICE:	DESCRIZIONE:	PAGINA:
CODE:	DESCRIPTION:	PAGE:
AL00255	DRIVER 24V 75W CLASSE II IP20 (5m)	426
07145	DRIVER 24V 150W CLASSE II IP20 (10m)	426

N.B. Per una scelta più ampia vedere il capitolo "Alimentatori" da pag.425
N.B. For a wider choice, see the chapter "Power supplies" from page 425

STRIPLED 120LED/m 12W/m 24Vdc

RIALIMENTABILE OGNI 20m / REPOWER EVERY 20m



Scheda tecnica
Datasheet

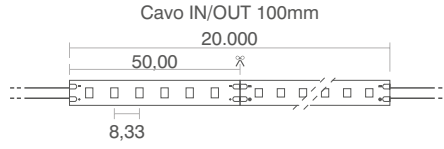

50,00 mm

SEZIONABILITÀ/CUT

misure in mm / measurements in mm

SUPER LONG DISTANCE - STRIPLED RIALIMENTABILE OGNI 20m
SUPER LONG DISTANCE - STRIPED REPOWER EVERY 20m



CODICE: CODE:	CCT (K)	W/m	Flusso luminoso/m reale (lm): Luminous flux/m real (lm):	Classe energetica: Energy rating:	
IP20					
05900	3000	12	1599		CRI: Ra>85 Durata utile: Useful lifespan: L70 B50 = 60.000h Tolleranza cromatica: Tolerance chromatic: 3 SDCM
05901	4000	12	1741		
05902	5800	12	1900		

CONTROLLER COMPATIBILI: COMPATIBLE CONTROLLER:

CODICE: CODE:	DESCRIZIONE: DESCRIPTION:	PAGINA: PAGE:
09369	DALI2-PUSH-0/1.10V 24V max.11A	446
ZQ20-04R0	Z-DIM Wireless single channel 24Vdc max.11A control via push button	472

ALIMENTATORI COMPATIBILI: COMPATIBLE DRIVER:

CODICE: CODE:	DESCRIZIONE: DESCRIPTION:	PAGINA: PAGE:
AL00251	DRIVER 24V 320W CLASSE II IP20	426

STRIPLED 120LED/m 12W/m 24Vdc

RIALIMENTABILE OGNI 20m / REPOWER EVERY 20m

SPECIAL
LINE



Scheda tecnica
Datasheet



10m



50,00 mm

SEZIONABILITÀ/CUT

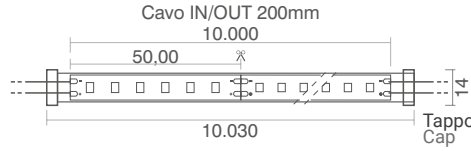

IP65



24 Vdc

IP65

10m

misure in mm / measurements in mm

SUPER LONG DISTANCE - STRIPLED RIALIMENTABILE OGNI 20m
SUPER LONG DISTANCE - STRIPED REPOWER EVERY 20m



CODICE: **CCT (K)** **W/m** **Flusso luminoso/m reale (lm):** **Classe energetica:**
CODE: DESCRIPTION: Luminous flux/m real (lm): Energy rating:

IP65

06513 3000 12 1599



06514 4000 12 1741



06515 5800 12 1900



CRI:
Ra>85

Durata utile:
Useful lifespan:
L70 B50 = 60.000h

Tolleranza cromatica:
Tolerance chromatic:
3 SDCM

CONTROLLER COMPATIBILI:
COMPATIBLE CONTROLLER:

CODICE: CODE:	DESCRIZIONE: DESCRIPTION:	PAGINA: PAGE:
09369	DALI2-PUSH-0/1.10V 24V max.11A	446
ZQ20-04R0	Z-DIM Wireless single channel 24Vdc max.11A control via push button	472

ALIMENTATORI COMPATIBILI:
COMPATIBLE DRIVER:

CODICE: CODE:	DESCRIZIONE: DESCRIPTION:	PAGINA: PAGE:
07145	DRIVER 24V 150W CLASSE II IP20	426

STRIPLLED 150LED/m 48Vdc

30m UNICA ALIMENTAZIONE / 30m SINGLE POWER SUPPLY



Scheda tecnica
Datasheet



100,00 mm

SEZIONABILITÀ/CUT

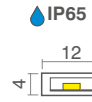
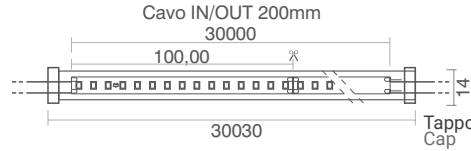
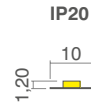
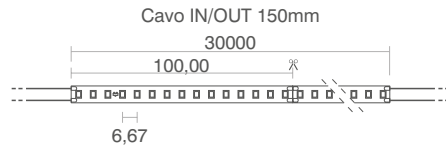

48 Vdc

IP20

IP65

30m

misure in mm / measurements in mm

SUPER LONG DISTANCE - 30m UNICA ALIMENTAZIONE

SUPER LONG DISTANCE - 30m SINGLE POWER SUPPLY



CODICE: CODE:	CODICE: CODE:	CCT (K)	W/m	Flusso luminoso/m reale (lm): Luminous flux/m real (lm):	Classe energetica: Energy rating:
------------------	------------------	---------	-----	---	--------------------------------------

IP20 IP65

06762	06765	2700	9,6	1415	
06763	06766	3000	9,6	1573	
06764	06767	4000	9,6	1604	



CRI:
Ra>80

Durata utile:
Useful lifespan:
L70 B50 = 60.000h

Tolleranza cromatica:
Tolerance chromatic:
3 SDCM

CONTROLLER COMPATIBILI:

COMPATIBLE CONTROLLER:

CODICE: CODE:	DESCRIZIONE: DESCRIPTION:	PAGINA: PAGE:
09370	DALI2-PUSH-0/1.10V 484V max.7A	447

ALIMENTATORI COMPATIBILI:

COMPATIBLE DRIVER:

CODICE: CODE:	DESCRIZIONE: DESCRIPTION:	PAGINA: PAGE:
07544	DRIVER 48V 480W IP65	428

STRIPILED COB 14W/m e 18W/m



Scheda tecnica
Datasheet



14W IP20 45,00 mm
18W IP20 38,00 mm
14W IP65 45,00 mm
SEZIONABILITÀ/CUT

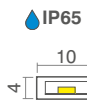
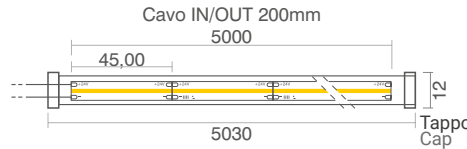
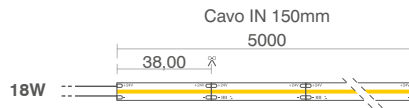
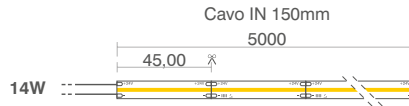

misure in mm / measurements in mm



SENZA PUNTI LUCE. MAGGIORE FLESSIBILITÀ E ANGOLO DI DIFFUSIONE DI 180°
WITHOUT LIGHT POINTS. GREATER FLEXIBILITY AND DIFFUSION ANGLE OF 180°



CODICE: CODE:	CODICE: CODE:	CCT (K)	W/m	Flusso luminoso/m reale (lm): Luminous flux/m real (lm):	Classe energetica: Energy rating:
IP20	IP65				
05506	05571	2700	14	1313	F A B
05507	05572	3000	14	1258	F A B
05508	05573	4000	14	1399	F A B
05509	05574	5800	14	1450	F A B
05911		2700	18	1467	F A B
05912		3000	18	1554	F A B
05913		4000	18	1680	F A B
05914		5800	18	1800	F A B

CRI:
Ra>94 R9>60

Durata utile:
Useful lifespan:
L70 B50 = 60.000h

Tolleranza cromatica:
Tolerance chromatic:
1 SDCM

CONTROLLER COMPATIBILI: COMPATIBLE CONTROLLER:

CODICE: CODE:	DESCRIZIONE: DESCRIPTION:	PAGINA: PAGE:
09369	DALI2-PUSH-0/1.10V 24V max.11A	446
ZQ20-04R0	Z-DIM Wireless single channel 24Vdc max.11A control via push button	472

ALIMENTATORI SUGGERITI PER 5 E 10m: SUGGESTED POWER SUPPLIES FOR 5 AND 10m:

CODICE: CODE:	DESCRIZIONE: DESCRIPTION:	PAGINA: PAGE:
07260	DRIVER 24V 100W CLASSE II IP20 (5m)	426
AL00252	DRIVER 24V 120W CLASSE II IP20 (5m)	426
AL00253	DRIVER 24V 180W CLASSE II IP20 (10m)	426
AL00251	DRIVER 24V 320W CLASSE II IP20 (10m)	426

N.B. Per una scelta più ampia vedere il capitolo "Alimentatori" da pag.425
N.B. For a wider choice, see the chapter "Power supplies" from page 425

STRIPILED 140LED/m 5W/m ETL

MERCATO AMERICANO / AMERICAN MARKET



Scheda tecnica
Datasheet

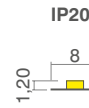
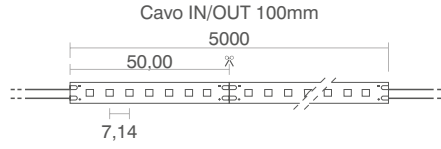

24 Vdc

IP20

5m



50,00 mm

SEZIONABILITÀ/CUT

misure in mm / measurements in mm



CODICE: **CCT (K)** **W/m** **Flusso luminoso/m reale (lm):** **Classe energetica:**
CODE: DESCRIPTION: Luminous flux/m real (lm): Energy rating:

IP20

06632	2700	5	656	
06633	3000	5	662	
06634	4000	5	705	

CRI:
Ra>90

Durata utile:
Useful lifespan:
L70 B50 = 60.000h

Tolleranza cromatica:
Tolerance chromatic:
3 SDCM

CONTROLLER COMPATIBILI: COMPATIBLE CONTROLLER:

CODICE: CODE:	DESCRIZIONE: DESCRIPTION:	PAGINA: PAGE:
09369	DALI2-PUSH-0/1.10V 24V max.11A	446
ZQ20-04R0	Z-DIM Wireless single channel 24Vdc max.11A control via push button	472

ALIMENTATORI SUGGERITI PER 5 E 10m: SUGGESTED POWER SUPPLIES FOR 5 AND 10m:

CODICE: CODE:	DESCRIZIONE: DESCRIPTION:	PAGINA: PAGE:
07210	DRIVER 24V 30W CLASSE II IP20 (5m)	426
AL00254	DRIVER 24V 60W CLASSE II IP20 (10m)	426

N.B. Per una scelta più ampia vedere il capitolo "Alimentatori" da pag.425
N.B. For a wider choice, see the chapter "Power supplies" from page 425

STRIPILED 210LED/m 14,4W/m ETL

MERCATO AMERICANO / AMERICAN MARKET



Scheda tecnica
Datasheet

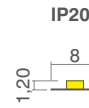
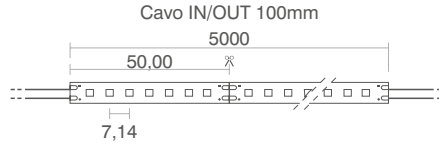

24 Vdc

IP20

5m



50,00 mm

SEZIONABILITÀ/CUT

misure in mm / measurements in mm



CODICE: **CCT (K)** **W/m** **Flusso luminoso/m reale (lm):** **Classe energetica:**
CODE: DESCRIPTION: Luminous flux/m real (lm): Energy rating:

IP20

CODICE	CCT (K)	W/m	Flusso luminoso/m reale (lm)	Classe energetica
06635	2700	14,4	1819	E A6
06636	3000	14,4	1836	E A6
06637	4000	14,4	1955	E A6

CRI:
Ra>90

Durata utile:
Useful lifespan:
L70 B50 = 60.000h

Tolleranza cromatica:
Tolerance chromatic:
3 SDCM

CONTROLLER COMPATIBILI: COMPATIBLE CONTROLLER:

CODICE:	DESCRIZIONE:	PAGINA:
CODE:	DESCRIPTION:	PAGE:
09369	DALI2-PUSH-0/1.10V 24V max.11A	446
ZQ20-04R0	Z-DIM Wireless single channel 24Vdc max.11A control via push button	472

ALIMENTATORI SUGGERITI PER 5 E 10m: SUGGESTED POWER SUPPLIES FOR 5 AND 10m:

CODICE:	DESCRIZIONE:	PAGINA:
CODE:	DESCRIPTION:	PAGE:
07260	DRIVER 24V 100W CLASSE II IP20 (5m)	426
AL00253	DRIVER 24V 180W CLASSE II IP20 (10m)	426

N.B. Per una scelta più ampia vedere il capitolo "Alimentatori" da pag.425
N.B. For a wider choice, see the chapter "Power supplies" from page 425

STRIPILED ZIG-ZAG

60 LED/m 4,8W



SPECIAL LINE



Scheda tecnica
Datasheet

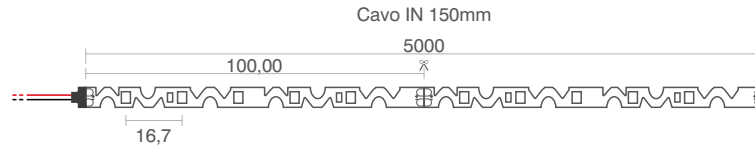

IP20



100,00 mm

SEZIONABILITÀ/CUT

misure in mm / measurements in mm



CODICE: **CCT (K)** **W/m** **Flusso luminoso/m reale (lm):** **Classe energetica:**
CODE: DESCRIPTION: Luminous flux/m real (lm): Energy rating:

IP20

06796	3000	4,8	380
06797	4000	4,8	420
06798	6000	4,8	400



CRI:
Ra>90

Durata utile:
Useful lifespan:
L70 B50 = 60.000h

Tolleranza cromatica:
Tolerance chromatic:
3 SDCM

CONTROLLER COMPATIBILI: COMPATIBLE CONTROLLER:

CODICE: CODE:	DESCRIZIONE: DESCRIPTION:	PAGINA: PAGE:
09369	DALI2-PUSH-0/1.10V 24V max.11A	446
ZQ20-04R0	Z-DIM Wireless single channel 24Vdc max.11A control via push button	472

ALIMENTATORI SUGGERITI PER 5 E 10m: SUGGESTED POWER SUPPLIES FOR 5 AND 10m:

CODICE: CODE:	DESCRIZIONE: DESCRIPTION:	PAGINA: PAGE:
07260	DRIVER 24V 100W CLASSE II IP20 (5m)	426
AL00253	DRIVER 24V 180W CLASSE II IP20 (10m)	426

N.B. Per una scelta più ampia vedere il capitolo "Alimentatori" da pag.425
N.B. For a wider choice, see the chapter "Power supplies" from page 425



Atmosfere di luce

Lighting atmospheres



Se desideri un'illuminazione multicolore e scenografica, ideale per dare vita a effetti di luce e atmosfere speciali, allora le stripled Scenographic Line fanno al caso tuo! Potrai scegliere tra diversi protocolli e tipologie: chiedi al nostro servizio clienti per soluzioni personalizzate.

If you desire unique and multicolored lighting, perfect for creating special light effects and atmospheres, then the Scenographic LED stripes is just what you need! You can choose from various protocols and types: ask our customer service for personalized solutions.





Tunable White

È la soluzione ideale per regolare la temperatura di colore della luce, da bianco freddo a bianco caldo, e la sua intensità, creando un ambiente stimolante che favorisce produttività e concentrazione.

It is the ideal solution for adjusting the colour temperature of light, from warm to cool white, and its intensity, creating a stimulating environment that fosters productivity and concentration.



Dim to Warm

Consente di gestire la temperatura di colore degli apparecchi, ottenendo variazioni graduali delle tonalità calde della luce, da 2700K a 1800K, attraverso la regolazione dell'intensità luminosa.

Allows the control of colour temperature through the regulation of the luminous intensity, providing smooth variations of warm light tones, from 2700K to 1800K.



RGB + Tunable White

Striplate che presentano tutto l'arco dei colori RGB e il bianco, dalle tonalità fredde a quelle più calde. E' possibile scegliere il colore bianco che si desidera e anche dimmerarlo.

LED stripes featuring the full range of RGB colors and white, from cool tones to warmer ones. It is possible to choose the desired shade of white and even dim it.

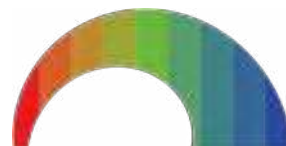

RGB / RGBW

La striscia LED RGB presenta tutta la gamma di colori derivante dalla combinazione dei colori rosso, verde e blu. La versione RGBW invece prevede un chip dedicato al bianco (caldo/freddo/neutro).

The RGB LED strip features the entire range of colors derived from the combination of red, green, and blue. The RGBW version includes a dedicated chip for white (warm/cool/neutral).



Monocolore Monochromatic

Ideali per ambienti in cui sia richiesta una personalizzazione dal punto di vista cromatico, senza variazioni dinamiche.
Colori disponibili: rosso / verde / blu.

Ideal for settings where customization from a chromatic point of view is required, without dynamic variations.
Available colors: red / green / blue.

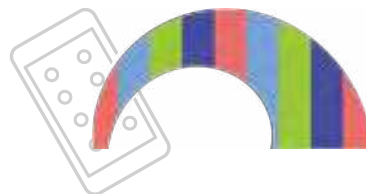

Pixel

Striplate RGBW con controllo individuale dei pixel, per scene di luce uniche e spettacolari. Possono essere gestite attraverso un apposito controller.

Striplate RGBW with single pixel control, for unique and spectacular light scenes. They can be controlled through a dedicated controller.

Creatività al tuo servizio

Creativity at your service

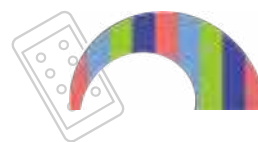

Le striped Pixel utilizzano la tecnologia Single Pixel che permette di controllare i singoli pixel che compongono la strip, dando la possibilità di scegliere diversi giochi di luce con tonalità e temi differenti.

Pixel LED strips use Single Pixel technology, which allows controlling the individual pixels that make up the strip, providing the possibility to choose various lighting effects with different shades and themes.

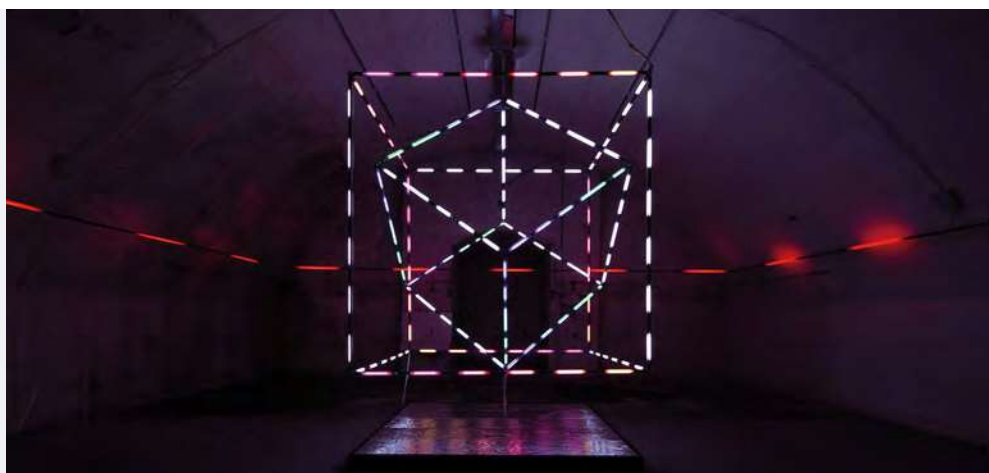
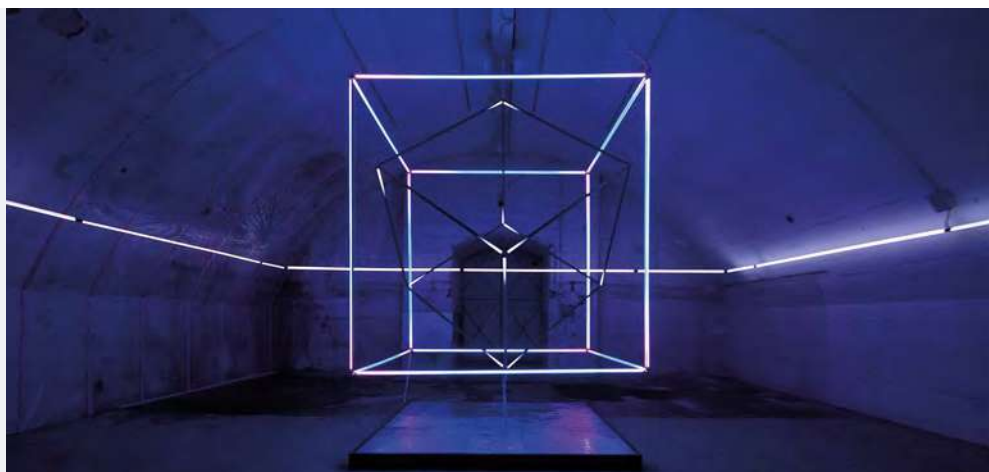
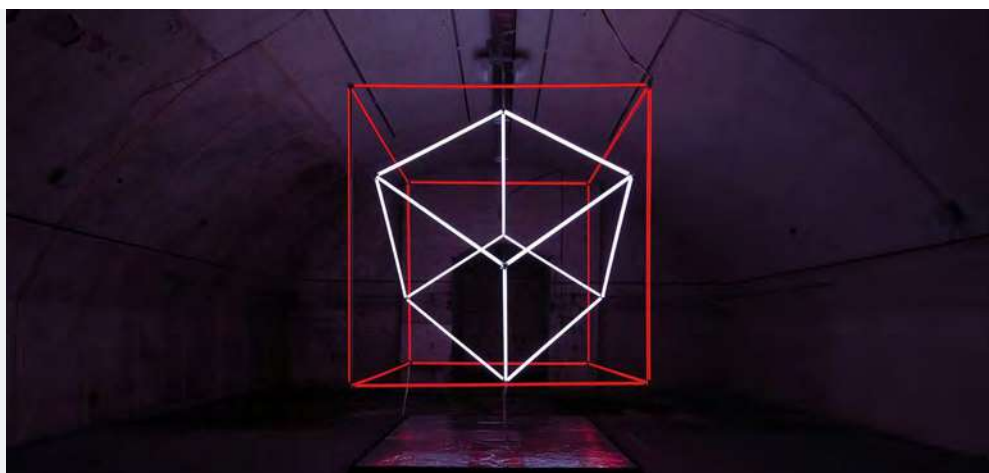



Sfumature di colore

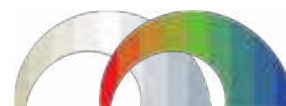

Shades of color

Le StripLED RGB+W combinano i colori RGB con la luce bianca per creare installazioni luminose che esaltano architetture sia interne che esterne. Questa versatilità nell'effetto cromatico consente di dare vita a scenari suggestivi e ambienti unici, catturando l'attenzione e creando un'esperienza visiva indimenticabile.

RGB+W StripLEDs combine RGB colors with white light to create luminous installations that enhance both indoor and outdoor architectures. This versatility in chromatic effects allows for the creation of evocative scenes and unique environments, capturing attention and providing an unforgettable visual experience.

STRIPLLED 60+60LED/m 14,4W/m

BIANCO DINAMICO / TUNABLE WHITE



Scheda tecnica
Datasheet

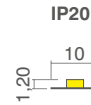
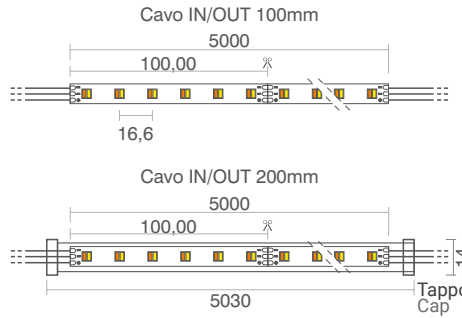
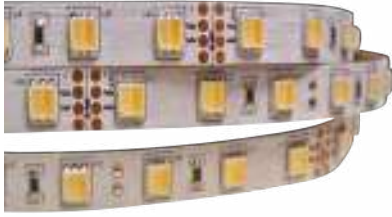

24 Vdc

IP20

IP65

5m



100,00 mm

SEZIONABILITÀ/CUT

misure in mm / measurements in mm

ALTA RESA CROMATICA CON SPETTRO SIMILE ALLA LUCE SOLARE
HIGH COLOR RENDERING WITH SPECTRUM SIMILAR TO SUNLIGHT



CODICE: **CODICE:** **CCT (K)** **W/m** **Flusso luminoso/m reale (lm):** **Classe energetica:**
CODE: CODE: Luminous flux/m real (lm): Energy rating:

IP20 IP65

05250 05251
2700 6000
14,4
800 1000



CRI:
Ra>85

Durata utile:
Useful lifespan:
L70 B50 = 60.000h

Tolleranza cromatica:
Tolerance chromatic:
3 SDCM

CONTROLLER COMPATIBILI: COMPATIBLE CONTROLLER:

CODICE: CODE:	DESCRIZIONE: DESCRIPTION:	PAGINA: PAGE:
09325	MULTIDIMMER PUSH/0-10V/0-5V/DMX512	450
09156	CONTROLLER TUNABLE WHITE	451
09287	MINI DIMMER BLUETOOTH - PUSH MONO	457
09346	VOICE COMMAND ALEXA/GOOGLE HOME WIFI	462
09309	DMX TOUCH PANEL 503 TUNABLE WHITE	459

ALIMENTATORI SUGGERITI PER 5 E 10m: SUGGESTED POWER SUPPLIES FOR 5 AND 10m:

CODICE: CODE:	DESCRIZIONE: DESCRIPTION:	PAGINA: PAGE:
07260	DRIVER 24V 100W CLASSE II IP20 (5m)	426
07145	DRIVER 24V 150W CLASSE II IP20 (10m)	426

N.B. Per una scelta più ampia vedere il capitolo "Alimentatori" da pag.425
N.B. For a wider choice, see the chapter "Power supplies" from page 425

STRIPLLED 120+120LED/m 19,2W/m

BIANCO DINAMICO PRO / TUNABLE WHITE PRO



Scheda tecnica
Datasheet

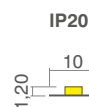
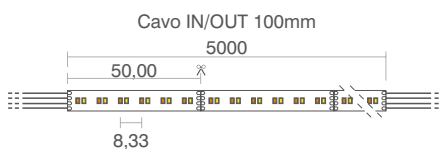

24 Vdc

IP20

5m



50,00 mm

SEZIONABILITÀ/CUT

misure in mm / measurements in mm

ALTA RESA CROMATICA CON SPETTRO SIMILE ALLA LUCE SOLARE

HIGH COLOR RENDERING WITH SPECTRUM SIMILAR TO SUNLIGHT



CODICE: CCT (K) W/m Flusso luminoso/m reale (lm): Classe energetica:
CODE: DESCRIPTION: Luminous flux/m real (lm): Energy rating:

IP20

06638

2300



19,2

700



CRI:
Ra>90

6500



1800

Durata utile:
Useful lifespan:
L70 B50 = 60.000h

Tolleranza cromatica:
Tolerance chromatic:
3 SDCM

CONTROLLER COMPATIBILI: COMPATIBLE CONTROLLER:

CODICE: CODE:	DESCRIZIONE: DESCRIPTION:	PAGINA: PAGE:
09325	MULTIDIMMER PUSH/0-10V/0-5V/DMX512	450
09156	CONTROLLER TUNABLE WHITE	451
09287	MINI DIMMER BLUETOOTH - PUSH MONO	457
09346	VOICE COMMAND ALEXA/GOOGLE HOME WIFI	462
09309	DMX TOUCH PANEL 503 TUNABLE WHITE	459

ALIMENTATORI SUGGERITI PER 5 E 10m: SUGGESTED POWER SUPPLIES FOR 5 AND 10m:

CODICE: CODE:	DESCRIZIONE: DESCRIPTION:	PAGINA: PAGE:
07145	DRIVER 24V 150W CLASSE II IP20 (5m)	426
AL00251	DRIVER 24V 320W CLASSE II IP20 (10m)	426

N.B. Per una scelta più ampia vedere il capitolo "Alimentatori" da pag.425
N.B. For a wider choice, see the chapter "Power supplies" from page 425

STRIPLLED 60LED/m 14,4W/m

RGB 



Scheda tecnica
Datasheet



100,00 mm

SEZIONABILITÀ/CUT

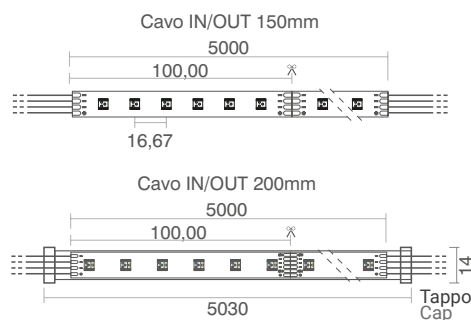

IP20



24 Vdc

IP20

IP65

5m

misure in mm / measurements in mm



CODICE: CODE:	CODICE: CODE:	CCT (K)	W/m	Flusso luminoso/m reale (lm): Luminous flux/m real (lm):
------------------	------------------	---------	-----	---

IP20 IP65

05049	05059	RGB	14,4	526
-------	-------	-----	------	-----

CONTROLLER COMPATIBILI: COMPATIBLE CONTROLLER:

CODICE: CODE:	DESCRIZIONE: DESCRIPTION:	PAGINA: PAGE:	CODICE: CODE:	DESCRIZIONE: DESCRIPTION:	PAGINA: PAGE:
09325	MULTI DIMMER PUSH/0-10V/0-5V/DMX512	450		CENTRALINE ZIGBEE	
09287	MINI DIMMER BLUETOOTH - PUSH MONO	457	09002	CENTRALINA GATEWAY	466
09000	CONTROLLER RGB+SIGNAL REPEATER	452	09003	DIMMER MONO RADIO-PUSH	468
09346	VOICE COMMAND ALEXA/GOOGLE HOME WIFI	462	09006	CONTROLLER MONO	468
09042	TOUCH CAPACITIVO RGB / RGB+W	460			

ALIMENTATORI SUGGERITI PER 5 E 10m: SUGGESTED POWER SUPPLIES FOR 5 AND 10m:

CODICE: CODE:	DESCRIZIONE: DESCRIPTION:	PAGINA: PAGE:
07260	DRIVER 24V 100W CLASSE II IP20 (5m)	426
AL00253	DRIVER 24V 180W CLASSE II IP20 (10m)	426

N.B. Per una scelta più ampia vedere il capitolo "Alimentatori" da pag.425
N.B. For a wider choice, see the chapter "Power supplies" from page 425

STRIPLLED 120LED/m 21W/m

RGB PRO 



Scheda tecnica
Datasheet

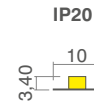
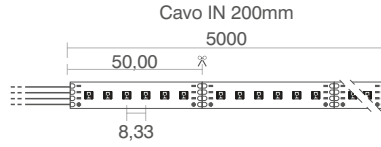

24 Vdc

IP20 

5m 

 **50,00 mm**
SEZIONABILITÀ/CUT

misure in mm / measurements in mm



CODICE: CCT (K) W/m Flusso luminoso/m reale (lm):
CODE: DESCRIPTION: Luminous flux/m real (lm):

IP20

05729	RGB 	21	ROSSO/RED: 140 VERDE/GREEN: 350 BLU/BLUE: 84LED
-------	---	----	---

CONTROLLER COMPATIBILI: COMPATIBLE CONTROLLER:

CODICE: CODE:	DESCRIZIONE: DESCRIPTION:	PAGINA: PAGE:	CODICE: CODE:	DESCRIZIONE: DESCRIPTION:	PAGINA: PAGE:
09325	MULTI DIMMER PUSH/0-10V/0-5V/DMX512	450		CENTRALINE ZIGBEE	
09287	MINI DIMMER BLUETOOTH - PUSH MONO	457	09002	CENTRALINA GATEWAY	466
09000	CONTROLLER RGB+SIGNAL REPEATER	452	09003	DIMMER MONO RADIO-PUSH	468
09346	VOICE COMMAND ALEXA/GOOGLE HOME WIFI	462	09006	CONTROLLER MONO	468
09042	TOUCH CAPACITIVO RGB / RGB+W	460			

ALIMENTATORI SUGGERITI PER 5 E 10m: SUGGESTED POWER SUPPLIES FOR 5 AND 10m:

CODICE: CODE:	DESCRIZIONE: DESCRIPTION:	PAGINA: PAGE:
07145	DRIVER 24V 150W CLASSE II IP20 (5m)	426
AL00251	DRIVER 24V 320W CLASSE II IP20 (10m)	426

N.B. Per una scelta più ampia vedere il capitolo "Alimentatori" da pag.425
N.B. For a wider choice, see the chapter "Power supplies" from page 425

STRIPILED 60LED/m 14,4W/m

RGB+W 



Scheda tecnica
Datasheet

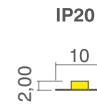
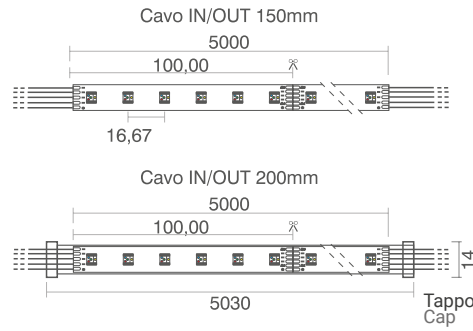

24 Vdc

IP20

IP65

5m



100,00 mm

SEZIONABILITÀ/CUT

misure in mm / measurements in mm



CODICE: CODE:	CODICE: CODE:	CCT (K)	W/m	Flusso luminoso/m reale (lm): Luminous flux/m real (lm):
IP20	IP65 			
05716	05831	RGB+W (2700K) 	14,4	536
05758	05795	RGB+W (3000K) 	14,4	549
05220	05225	RGB+W (4000K) 	14,4	1005

CONTROLLER COMPATIBILI: COMPATIBLE CONTROLLER:

CODICE: CODE:	DESCRIZIONE: DESCRIPTION:	PAGINA: PAGE:	CODICE: CODE:	DESCRIZIONE: DESCRIPTION:	PAGINA: PAGE:
				CENTRALINE ZIGBEE	
09325	MULTIDIMMER PUSH/0-10V/0-5V/DMX512	450			
09145	CONTROLLER RGB + W	453	09002	CENTRALINA GATEWAY	466
09287	MINI DIMMER BLUETOOTH - PUSH MONO	457	09003	DIMMER MONO RADIO-PUSH	468
09346	VOICE COMMAND ALEXA/GOOGLE HOME WIFI	462	09006	CONTROLLER MONO	468
09042	TOUCH CAPACITIVO RGB / RGB+W	460			

ALIMENTATORI SUGGERITI PER 5 E 10m: SUGGESTED POWER SUPPLIES FOR 5 AND 10m:

CODICE: CODE:	DESCRIZIONE: DESCRIPTION:	PAGINA: PAGE:
07260	DRIVER 24V 100W CLASSE II IP20 (5m)	426
AL00253	DRIVER 24V 180W CLASSE II IP20 (10m)	426

N.B. Per una scelta più ampia vedere il capitolo "Alimentatori" da pag.425
N.B. For a wider choice, see the chapter "Power supplies" from page 425

STRIPILED 140LED/m 28,8W/m

RGB+W PRO 



Scheda tecnica
Datasheet

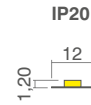
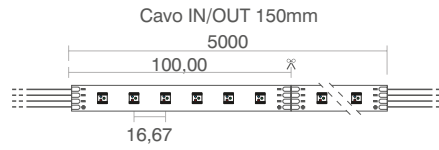

24 Vdc

IP20

5m



100,00 mm

SEZIONABILITÀ/CUT

misure in mm / measurements in mm



CODICE: CCT (K) W/m Flusso luminoso/m reale (lm):
CODE: DESCRIPTION: PAGE: Luminous flux/m real (lm):

CODICE:	CCT (K)	W/m	Flusso luminoso/m reale (lm):
IP20			Luminous flux/m real (lm):
06589	RGB+W (3000K) 	28,8	Bianco/White: 1663 Rosso/Red: 132 Verde/Green: 319 Blu/Blue: 89

CONTROLLER COMPATIBILI: COMPATIBLE CONTROLLER:

CODICE:	DESCRIZIONE:	PAGINA:	CODICE:	DESCRIZIONE:	PAGINA:
CODE:	DESCRIPTION:	PAGE:	CODE:	DESCRIPTION:	PAGE:
				CENTRALINE ZIGBEE	
09325	MULTIDIMMER PUSH/0-10V/0-5V/DMX512	450			
09145	CONTROLLER RGB + W	453	09002	CENTRALINA GATEWAY	466
09287	MINI DIMMER BLUETOOTH - PUSH MONO	457	09003	DIMMER MONO RADIO-PUSH	468
09346	VOICE COMMAND ALEXA/GOOGLE HOME WIFI	462	09006	CONTROLLER MONO	468
09042	TOUCH CAPACITIVO RGB / RGB+W	460			

ALIMENTATORI SUGGERITI PER 5 E 10m: SUGGESTED POWER SUPPLIES FOR 5 AND 10m:

CODICE:	DESCRIZIONE:	PAGINA:
CODE:	DESCRIPTION:	PAGE:
07260	DRIVER 24V 100W CLASSE II IP20	426

N.B. Per una scelta più ampia vedere il capitolo "Alimentatori" da pag.425
N.B. For a wider choice, see the chapter "Power supplies" from page 425

STRIPLLED 120LED/m 24W/m

ROSSO-VERDE-BLU / RED-GREEN-BLUE



Scheda tecnica
Datasheet

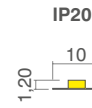
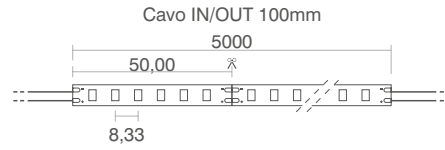

24 Vdc

IP20

5m



50,00 mm

SEZIONABILITÀ/CUT

misure in mm / measurements in mm

MONOCROMATICA
MONOCHROMATIC



CODICE: CODE:	CCT (K)	W/m	Flusso luminoso/m reale (lm): Luminous flux/m real (lm):
------------------	---------	-----	---

IP20

06666	ROSSO RED	24	516
06667	VERDE GREEN	24	1800
06668	BLU BLUE	24	335

CONTROLLER COMPATIBILI: COMPATIBLE CONTROLLER:

CODICE: CODE:	DESCRIZIONE: DESCRIPTION:	PAGINA: PAGE:
09369	DALI2-PUSH-0/1.10V 24V max.11A	446
ZQ20-04R0	Z-DIM Wireless single channel 24Vdc max.11A control via push button	472

ALIMENTATORI SUGGERITI PER 5 E 10m: SUGGESTED POWER SUPPLIES FOR 5 AND 10m:

CODICE: CODE:	DESCRIZIONE: DESCRIPTION:	PAGINA: PAGE:
07145	DRIVER 24V 150W CLASSE II IP20 (5m)	426
AL00251	DRIVER 24V 320W CLASSE II IP20 (10m)	426

N.B. Per una scelta più ampia vedere il capitolo "Alimentatori" da pag.425
N.B. For a wider choice, see the chapter "Power supplies" from page 425

STRIPLLED 60LED/m 10,5W/m

RGB+BIANCO DINAMICO / RGB+TUNABLE WHITE



Scheda tecnica
Datasheet

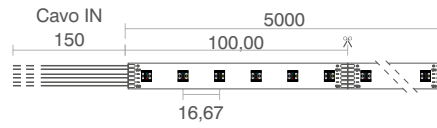

24 Vdc

IP20

5m

100,00 mm
SEZIONABILITÀ/CUT

misure in mm / measurements in mm

INTRATTENIMENTO E ILLUMINAZIONE ENTERTAINMENT AND LIGHTING



CODICE: **CODICE:** **CCT (K)** **W/m** **Flusso luminoso/m reale (lm):** **Classe energetica:**
CODE: CODE: CCT (K) W/m Luminous flux/m real (lm): Energy rating:

IP20

05821

RGB
+
TUNABLE
WHITE



10,5

395



CRI:
Ra>85 (3000K)

Durata utile:
Useful lifespan:
L70 B50 = 60.000h

CONTROLLER COMPATIBILI: COMPATIBLE CONTROLLER:

CODICE: CODE:	DESCRIZIONE: DESCRIPTION:	PAGINA: PAGE:	CODICE: CODE:	DESCRIZIONE: DESCRIPTION:	PAGINA: PAGE:
09325	MULTIDIMMER PUSH/0-10V/0-5V/DMX512	450		CENTRALINE ZIGBEE	
09145	CONTROLLER RGB + W	453	09002	CENTRALINA GATEWAY	466
09287	MINI DIMMER BLUETOOTH - PUSH MONO	457	09003	DIMMER MONO RADIO-PUSH	468
09346	VOICE COMMAND ALEXA/GOOGLE HOME WIFI	462	09006	CONTROLLER MONO	468
09042	TOUCH CAPACITIVO RGB / RGB+W	460			

ALIMENTATORI SUGGERITI PER 5 E 10m: SUGGESTED POWER SUPPLIES FOR 5 AND 10m:

CODICE: CODE:	DESCRIZIONE: DESCRIPTION:	PAGINA: PAGE:
AL00255	DRIVER 24V 75W CLASSE II IP20 (5m)	426
07145	DRIVER 24V 150W CLASSE II IP20 (10m)	426

N.B. Per una scelta più ampia vedere il capitolo "Alimentatori" da pag.425
N.B. For a wider choice, see the chapter "Power supplies" from page 425

STRIPLLED 240LED/m 20W/m

DIM TO WARM 



Scheda tecnica
Datasheet

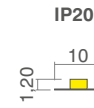
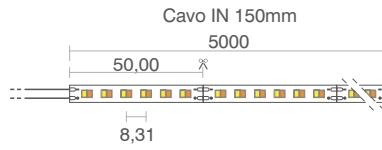

24 Vdc

IP20 

5m 

 **50,00 mm**
SEZIONABILITÀ/CUT

misure in mm / measurements in mm

TEMPERATURA DI COLORE RIDOTTA PER CREARE SCENARI ACCOGLIENTI E RILASSANTI
REDUCED COLOR TEMPERATURE TO CREATE COSY AND RELAXING SCENARIOS



CODICE: CODE:	CCT (K)	W/m	Flusso luminoso/m reale (lm): Luminous flux/m real (lm):	Classe energetica: Energy rating:
-------------------------	----------------	------------	--	---

IP20

06107

3000~1800

20

1798 (3000K)



CRI:
Ra>90

Durata utile:
Useful lifespan:
L70 B50 = 60.000h

Tolleranza cromatica:
Tolerance chromatic:
3 SDCM

CONTROLLER COMPATIBILI: COMPATIBLE CONTROLLER:

CODICE: CODE:	DESCRIZIONE: DESCRIPTION:	PAGINA: PAGE:
09369	DALI2-PUSH-0/1.10V 24V max.11A	446
ZQ20-04R0	Z-DIM Wireless single channel 24Vdc max.11A control via push button	472

ALIMENTATORI SUGGERITI PER 5 E 10m: SUGGESTED POWER SUPPLIES FOR 5 AND 10m:

CODICE: CODE:	DESCRIZIONE: DESCRIPTION:	PAGINA: PAGE:
07145	DRIVER 24V 150W CLASSE II IP20 (5m)	426
AL00251	DRIVER 24V 320W CLASSE II IP20 (10m)	426

N.B. Per una scelta più ampia vedere il capitolo "Alimentatori" da pag.425
N.B. For a wider choice, see the chapter "Power supplies" from page 425



STRIPILED DIGITALE

60LED/m 7,8W

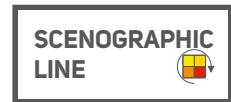

Scheda tecnica
Datasheet

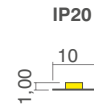
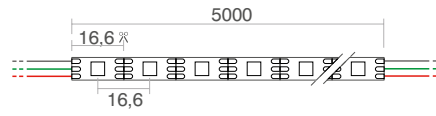

IP20

12 Vdc

IP20

5m



16,60 mm

SEZIONABILITÀ/CUT

misure in mm / measurements in mm



CODICE: CCT (K) W/m Flusso luminoso/m reale (lm):
CODE: DESCRIPTION: Luminous flux/m real (lm):

IP20

06800 3000  7,8 430

CRI:
Ra>80

Durata utile:
Useful lifespan:
L70 B50 = 50.000h

Tolleranza cromatica:
Tolerance chromatic:
5 SDCM

CONTROLLER COMPATIBILI:
COMPATIBLE CONTROLLER:

CODICE:	DESCRIZIONE:
CODE:	DESCRIPTION:
09770	TOUCH WIRELESS
09771	AMPLIFICATORE DI SEGNALE SIGNAL AMPLIFIER

ALIMENTATORE COMPATIBILE:
COMPATIBLE POWER SUPPLIES:

CODICE:	DESCRIZIONE:
CODE:	DESCRIPTION:
07271	DRIVER 12V 150W IP67

STRIPILED DIGITALE RGB+W PIXEL

60LED/m 12Vdc



Scheda tecnica
Datasheet

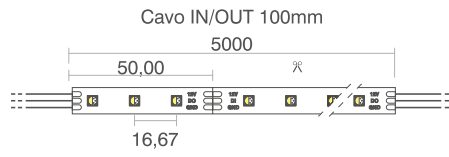

12 Vdc

IP20

5m

50,00 mm
SEZIONABILITÀ/CUT

misure in mm / measurements in mm



CODICE: CODE:	CCT (K)	W/m	Flusso luminoso/m reale (lm): Luminous flux/m real (lm):
------------------	---------	-----	---

IP20

06631	RGB+W (3000K)	15	121
-------	---------------	----	-----

CONTROLLER COMPATIBILI: COMPATIBLE CONTROLLER:

CODICE: CODE:	DESCRIZIONE: DESCRIPTION:	PAGINA: PAGE:
09347	BLUETOOTH (MAX. 2048 PIXEL)	469
09348	CONTROLLER SD CARD	469
09349	CONTROLLER+RC (MAX. 2048 PIXEL)	469

I dettagli fanno la differenza

FOOD
LINE



Details make the difference

Le StripLED della Linea Food sono sviluppate per mettere in risalto le caratteristiche specifiche di ogni alimento: carne, pesce, ortofrutta, prodotti da forno e latticini.

Anche l'occhio vuole la sua parte!

The strip LEDs from the Food Line are specifically designed to highlight the unique features of different types of food, such as meat, fish, fruits and vegetables, bakery products, and dairy.

Appearance matters, too!



Caratteristiche

Features

Appositamente studiate per illuminare i prodotti alimentari, restituendo al meglio i colori. Grazie alla bassissima emissione di calore, non provocano alterazioni e ne preservano la freschezza.

Specifically designed to illuminate food products, restoring the colors at best. Thanks to the very low heat emission, they do not cause alterations and preserve their freshness.

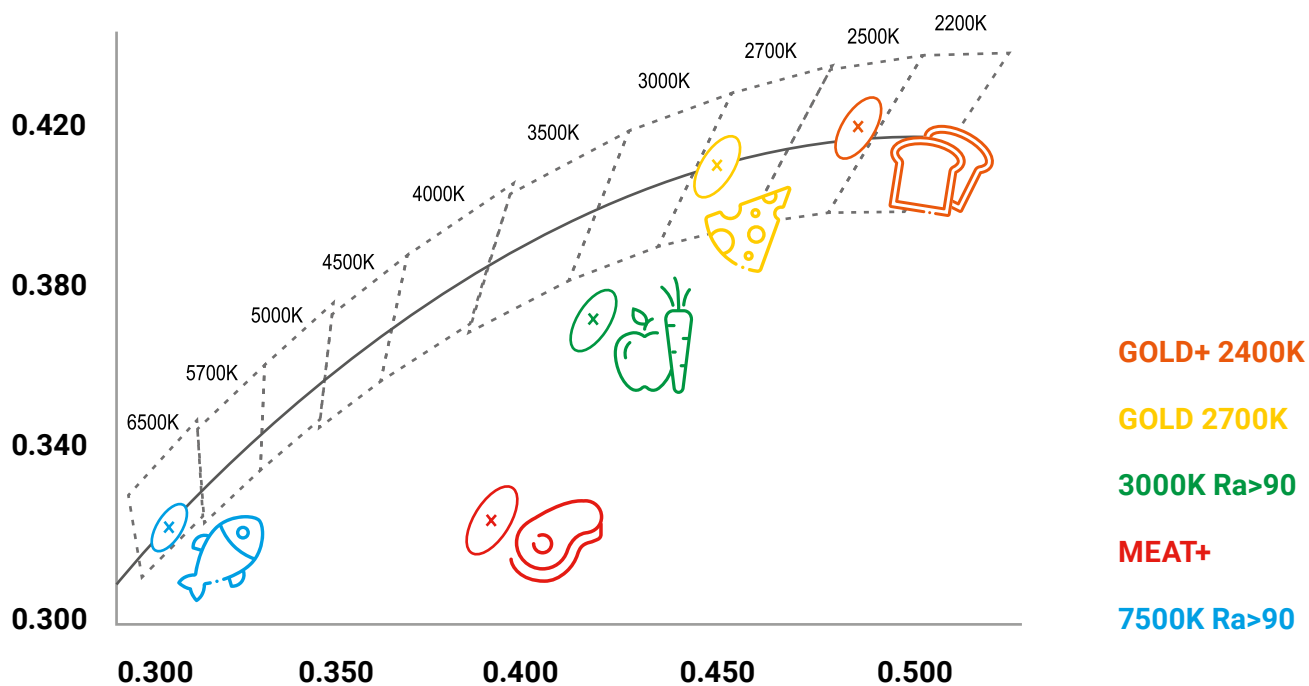

STRIPLLED 112LED/m 16,8W/m



Scheda tecnica
Datasheet

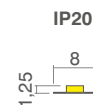
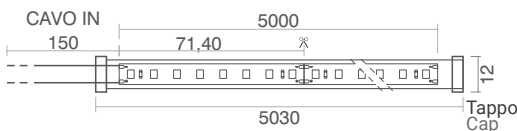
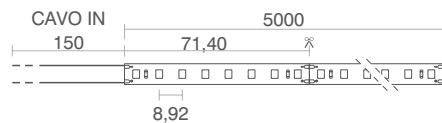

24 Vdc

IP20

IP65

5m

misure in mm / measurements in mm

71,40 mm
SEZIONABILITÀ/CUT

ALTA RESA CROMATICA PER L'ILLUMINAZIONE DI ALIMENTI
HIGH COLOR RENDERING FOR FOOD LIGHTING



CODICE: CODE:	CODICE: CODE:		W/m	Flusso luminoso/m reale (lm): Luminous flux/m real (lm):	Classe energetica: Energy rating:
IP20	IP65				
06061	06069	PANE	16,8	1618	
06062	06070	CARNE	16,8	1520	
06063	06071	FRUTTA	16,8	1650	
06064	06072	VERDURA	16,8	1880	
06065	06073	PESCE	16,8	1900	

CRI:
Ra>95

Durata utile:
Useful lifespan:
L70 B50 = 60.000h

Tolleranza cromatica:
Tolerance chromatic:
3 SDCM

CONTROLLER COMPATIBILI:
COMPATIBLE CONTROLLER:

CODICE: CODE:	DESCRIZIONE: DESCRIPTION:	PAGINA: PAGE:
09369	DALI2-PUSH-0/1.10V 24V max.11A	446
ZQ20-04R0	Z-DIM Wireless single channel 24Vdc max.11A control via push button	472

ALIMENTATORI SUGGERITI PER 5 E 10m:
SUGGESTED POWER SUPPLIES FOR 5 AND 10m:

CODICE: CODE:	DESCRIZIONE: DESCRIPTION:	PAGINA: PAGE:
AL00252	DRIVER 24V 120W CLASSE II IP20 (5m)	426
AL00251	DRIVER 24V 320W CLASSE II IP20 (10m)	426

N.B. Per una scelta più ampia vedere il capitolo "Alimentatori" da pag.425
N.B. For a wider choice, see the chapter "Power supplies" from page 425



La luce diventa semplice **220vac**

Light becomes simple

Queste particolari striped possono essere direttamente collegate alla corrente, senza necessità di acquistare driver specifici, collegandole direttamente alla tensione 220 Vac. Più semplice di così!

These specific LED strips can be conveniently connected to the power supply without the need for additional drivers, as they come with a plug already attached to the reel. It doesn't get any simpler than this!





Caratteristiche

Features

- Collegamento diretto alla corrente
Direct connection to the power supply
- Qualità della luce
Quality of light
- Ricollegabile ogni 50mt
Reconnection every 50mt



Indice di resa cromatica

Colour Rendering Index

Elevato CRI>90 per brillantezza e colori uniformi.
High CRI<90 for brightness and uniform colours.



Applicazioni

Applications

- Residenziale outdoor
Residential
- Retail outdoor
- Hospitality outdoor



Customizzazione

Customization

Le nostre striped possono essere customizzate su specifica richiesta. Contatta il nostro servizio clienti.

Our LEDstrips can be customized under specifications. Our customer service can support you.

STRIPILED 120LED/m 18W/m 220Vac



Scheda tecnica
Datasheet

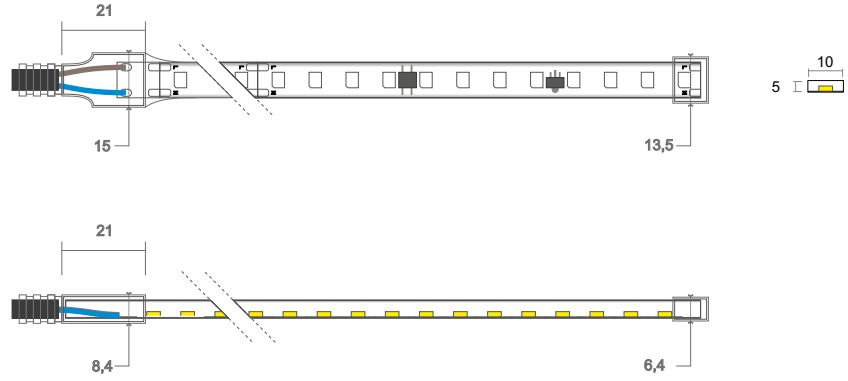

100,00 mm
SEZIONABILITÀ/CUT

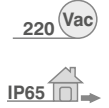

misure in mm / measurements in mm

SENZA RADDRIZZATORE
WITHOUT RECTIFIER

UTILIZZABILE SOLO PER APPLICAZIONI OUTDOOR
CAN ONLY BE USED FOR OUTDOOR APPLICATIONS



CODICE: CODE: **CCT (K)** **W/m** **Flusso luminoso/m reale (lm):** Luminous flux/m real (lm): **Classe energetica:** Energy rating:

IP65

Length	Code	CCT (K)	W/m	Flusso luminoso/m reale (lm)
50m	06109	2700	18	1460
	06240	3000	18	1620
	06241	4000	18	1650
	06242	6500	18	1750
25m	06109-25	2700	18	1460
	06240-25	3000	18	1620
	06241-25	4000	18	1650
	06242-25	6500	18	1750
5m	06109-5	2700	18	1460
	06240-5	3000	18	1620
	06241-5	4000	18	1650
	06242-5	6500	18	1750



CRI:
Ra>90

Durata utile:
Useful lifespan:
L70 B50 = 50.000h

Intervallo di taglio:
Cutting range:
100 mm

ACCESSORI:
ACCESSORIES:

14870
Molletta di fissaggio trasp. 14xH8,5xL20mm
Fixing clip transp. 14xH8,5xL20mm

CONTROLLER COMPATIBILI:
COMPATIBLE CONTROLLER:

CODICE:	DESCRIZIONE:
CODE:	DESCRIPTION:
09356	Taglio di fase PUSH (max.200W) PUSH phase cut (max.200W)
09360	Taglio di fase PUSH/BLUETOOTH (max.200W) Phase cut PUSH/BLUETOOTH (max.200W)

PROFILI COMPATIBILI:
COMPATIBLE PROFILE:

CODICE:	PAGINA:
CODE:	PAGE:
1813 Plafone/Ceiling	152
1616 Angolare/Angular	177



Index

1. Neonflex

	Pag.
Neonflex 1616-B vertical	112
Neonflex 1616-S horizontal	113
Neonflex 1616-A angular	114
Neonflex 1810	115
Neonflex 0612	116
Neonflex 0410	117
Neonflex 1010-S horizontal	118
Neonflex 1010-B vertical	119
Neonflex TUBE	122

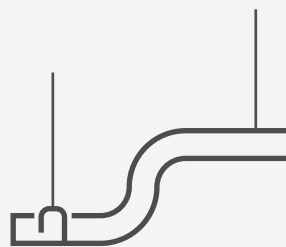

Neon flex

Neon flex LED

Versatili e sorprendenti, queste strisce luminose rappresentano l'ideale soluzione per i vostri progetti di illuminazione. Sono adatte a creare ambienti unici e suggestivi, rendendo ogni spazio davvero speciale, grazie alla loro flessibilità e possibilità di personalizzazione.

Inserendo le StripLED in un profilo cavo flessibile in silicone, otteniamo le Neon Flex che offrono un'ampia gamma di opzioni di installazione e design, permettendo di giocare con curve e linee per una luminosità su misura.

Versatile and astonishing, the Neon Flex LED strips represent the ideal lighting solution for your projects. They are perfect for creating unique and captivating environments, making each space truly special, thanks to their flexibility and customization possibilities.

By inserting the StripLEDs in a flexible silicone cable profile, we get the Neon Flex that offer a wide range of installation and design options, allowing you to play with curves and lines for tailored brightness.

Luce intensa, eleganza estrema

Bright light, extreme elegance

Le stripLED Neon Flex offrono una soluzione affidabile per l'illuminazione in ambienti esterni ed interni grazie al rivestimento in silicone opaco antistatico, che fornisce una protezione efficace con un elevato grado di protezione IP. Questa caratteristica le rende resistenti all'umidità, agli agenti atmosferici e alle condizioni ambientali avverse.

The Neon Flex LED strips offer a reliable lighting solution for outdoor and indoor environments, thanks to their opaque anti-static silicone coating, providing effective protection with a high IP protection rating. This makes them resistant to moisture, weather elements, and adverse environmental conditions.



La struttura delle stripLED Neon Flex consente un'ampia diffusione della luce, garantendo risultati luminosi brillanti e uniformi, per effetti luminosi intensi e omogenei, aggiungendo un tocco di fascino e originalità ai progetti di illuminazione.

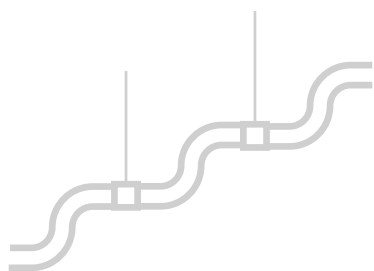

Approccio modulare

Modular Approach

Abbraccia il potere dei principi di design modulare. I nostri prodotti non sono solo innovativi e facili da installare, ma consentono anche un'efficace gestione delle scorte.

Embrace the power of modular design principles. Our products are not only innovative and easy to install but also allow for effective stocking.

The structure of Neon Flex LED strips ensures brilliant and uniform lighting results thanks to the wide light diffusion, for creating intense and homogeneous lighting effects, adding charm and originality to your lighting projects.



Versatilità illimitata

Limitless Versatility

Libera la creatività infinita dei designer superando i limiti dello spazio. Integra in modo armonioso luce e spazio, raggiungendo un risultato armonioso e ispiratore.

Break free from space limitations and unleash infinite creativity for designers. Seamlessly integrate light and space, achieving a harmonious and inspiring result.



Personalizzazione flessibile

Flexible personalization

Sostenuti dallo spirito di libera applicazione e diverse richieste, offriamo opzioni di personalizzazione flessibili per caratteristiche fotoelettriche, lunghezza e funzioni speciali.

Empowered by the spirit of free application and diverse demands, we offer flexible customization options for photoelectric features, length, and special functions.

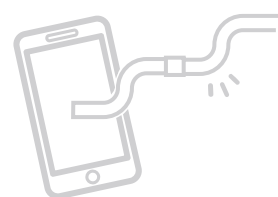

Connessione intelligente

Smart connectivity

Sincronizzati intelligentemente con tecnologie di regolazione e controllo smart, eleviamo la tua esperienza di illuminazione a un livello più intelligente.

Intelligently sync with mainstream dimming and smart control technologies, elevating your lighting experience to a smarter level.

NEONFLEX 1616-B movimento verticale

vertical movement



Scheda tecnica
Datasheet

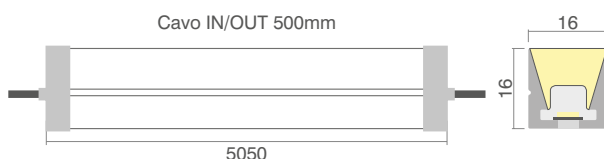
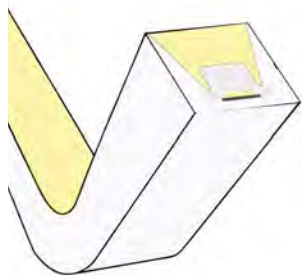

misure in mm / measurements in mm

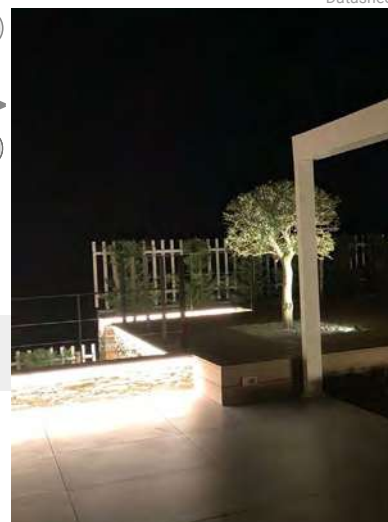

POSSIBILITA' CUSTOMIZZAZIONE FINO 10m *
POSSIBILITY OF CUSTOMIZATION UP TO 10m *

CE IP65

Guaina+StripLED+Tappi chiusi+10 Staffe+cavi IN/OUT
Sheath+StripLED+Closed caps+10 Brackets+IN/OUT cables

CODICE: CODE:	CCT (K)	W/m	Flusso in uscita (lm): Flow out (lm)	Intervallo taglio (mm): Cutting range (mm):
------------------	---------	-----	---	--

05892	Bianco 2700K White 2700K	14,9	1174	83,33
05891	Bianco 3000K White 3000K	14,9	1252	83,33
05890	Bianco 4000K White 4000K	14,9	1342	83,33
05889	Bianco 5800K White 5800K	14,9	1512	83,33
06596-D	Bianco dinamico Dynamic white	14,4	600	100,00
06596-H	RGB	14,4		100,00

CRI:
Ra>90

Durata utile:
Useful lifespan:
L70 B50 = 60.000h

Tolleranza cromatica:
Tolerance chromatic:
3 SDCM

CODICI COMPONENTI SINGOLI:

SINGLE COMPONENTS CODES:

TAPPI

CAPS

CODICE
CODE

14836 / 14835

Passacavo/chiuso
Grommet/closed

FISSAGGIO

FIXING

CODICE
CODE

14833

Staffa di fissaggio 18xH22,5xL30mm
Fixing bracket 18xH22,5xL30mm

14696-L20

Profilo di fissaggio L=2000mm
Fixing profile L=2000mm



STRIPLED COMPATIBILI PER CUSTOMIZZAZIONE*:

STRIPLED COMPATIBLE FOR CUSTOMIZATION*:

PROFESSIONAL

IP20 4,9W / 9,9W / 14,9W / 8,5W / 16W

PAGINA:
PAGE:

da 34 a 45

SCENOGRAPHIC

IP20 DW / RGB / RGB+W

PAGINA:
PAGE:

da 88 a 98

BUSINESS

IP20 6,5W / 12,5W

da 48 a 52

SPECIAL

IP20 11W / 12W

da 74 a 82

NEONFLEX 1616-S movimento orizzontale

horizontal movement



Scheda tecnica
Datasheet

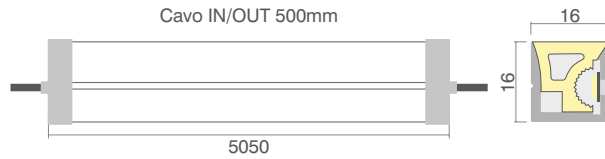
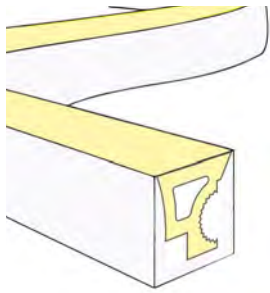

misure in mm / measurements in mm

POSSIBILITA' CUSTOMIZZAZIONE FINO 10m*
POSSIBILITY OF CUSTOMIZATION UP TO 10m*

CE IP65

Guaina+StripLED+Tappi chiusi+10 Staffe+cavi IN/OUT
Sheath+StripLED+Closed caps+10 Brackets+IN/OUT cables

CODICE: CODE:	CCT (K)	W/m	Flusso in uscita (lm): Flow out (lm)	Intervallo taglio (mm): Cutting range (mm):
06254	Bianco 2700K White 2700K	14,9	1174	83,33
06255	Bianco 3000K White 3000K	14,9	1252	83,33
06256	Bianco 4000K White 4000K	14,9	1342	83,33
06257	Bianco 5800K White 5800K	14,9	1512	83,33
06597-D	Bianco dinamico Dynamic white	14,4	600	100,00
06597-H	RGB	14,4		100,00

CRI:
Ra>90

Durata utile:
Useful lifespan:
L70 B50 = 60.000h

Tolleranza cromatica:
Tolerance chromatic:
3 SDCM

CODICI COMPONENTI SINGOLI: SINGLE COMPONENTS CODES:

TAPPI

CAPS

CODICE
CODE

14836 / 14835

Passacavo/chiuso
Grommet/closed

FISSAGGIO

FIXING

CODICE
CODE

14833

Staffa di fissaggio 18xH22,5xL30mm
Fixing bracket 18xH22,5xL30mm

14696-L20

Profilo di fissaggio L=2000mm
Fixing profile L=2000mm



STRIPLED COMPATIBILI PER CUSTOMIZZAZIONE*:

STRIPLED COMPATIBLE FOR CUSTOMIZATION*:

PROFESSIONAL

IP20 4,9W/9,9W/14,9W/8,5W/16W

BUSINESS

IP20 6,5W/12,5W

SPECIAL

IP20 11W/12W

PAGINA:

PAGE:

da 34 a 45

da 48 a 52

da 74 a 82

PAGINA:

PAGE:

SCENOGRAPHIC

IP20 DW / RGB / RGB+W

da 88 a 98

NEONFLEX 1616-A angolare

angular



Scheda tecnica
Datasheet

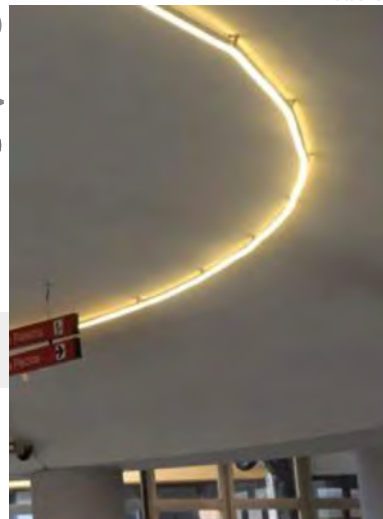
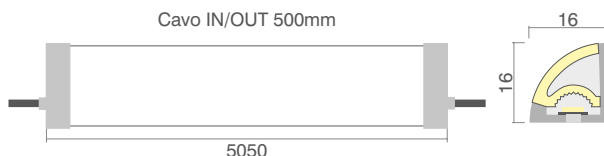
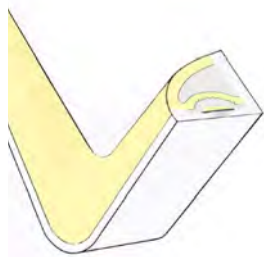

misure in mm / measurements in mm

POSSIBILITA' CUSTOMIZZAZIONE FINO 10m*
POSSIBILITY OF CUSTOMIZATION UP TO 10m*

CE IP65

Guaina+StripLED+Tappi chiusi+10 Staffe+cavi IN/OUT
Sheath+StripLED+Closed caps+10 Brackets+IN/OUT cables

CODICE: CODE:	CCT (K)	W/m	Flusso in uscita (lm): Flow out (lm)	Intervallo taglio (mm): Cutting range (mm):
------------------	---------	-----	---	--

06228	Bianco 2700K White 2700K	14,9	1174	83,33
06229	Bianco 3000K White 3000K	14,9	1252	83,33
06249	Bianco 4000K White 4000K	14,9	1342	83,33
06253	Bianco 5800K White 5800K	14,9	1512	83,33
06598-D	Bianco dinamico Dynamic white	14,4	600	100,00
06598-H	RGB	14,4		100,00

CRI:
Ra>90

Durata utile:
Useful lifespan:
L70 B50 = 60.000h

Tolleranza cromatica:
Tolerance chromatic:
3 SDCM

CODICI COMPONENTI SINGOLI:

SINGLE COMPONENTS CODES:

TAPPI

CAPS

CODICE
CODE

14830 / 14829

Passacavo/chiuso
Grommet/closed

FISSAGGIO

FIXING



CODICE
CODE

14831

Staffa di fissaggio 17xH19xL15mm
Fixing bracket 17xH19xL15mm

14831-L20

Profilo di fissaggio L=2000mm
Fixing profile L=2000mm

STRIPLED COMPATIBILI PER CUSTOMIZZAZIONE*:

STRIPLED COMPATIBLE FOR CUSTOMIZATION*:

PROFESSIONAL

IP20 4,9W / 9,9W / 14,9W / 8,5W / 16W

PAGINA:

PAGE:

da 34 a 45

SCENOGRAPHIC

IP20 DW / RGB / RGB+W

PAGINA:

PAGE:

da 88 a 98

BUSINESS

IP20 6,5W / 12,5W

da 48 a 52

SPECIAL

IP20 11W / 12W

da 74 a 82

NEONFLEX 1810

movimento orizzontale
horizontal movement



Scheda tecnica
Datasheet

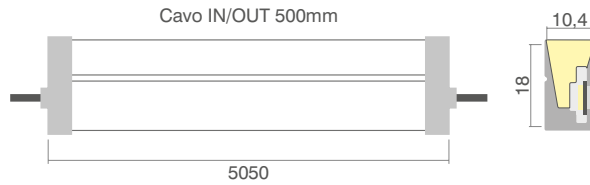
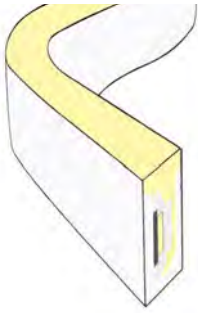

misure in mm / measurements in mm

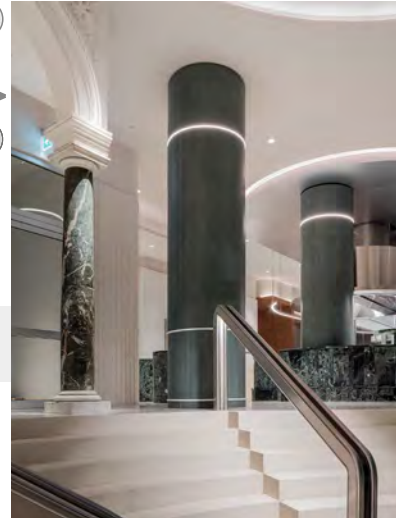

POSSIBILITA' CUSTOMIZZAZIONE FINO 10m*
POSSIBILITY OF CUSTOMIZATION UP TO 10m*

CE IP65

Guaina+StripLED+Tappi chiusi+10 Staffe+cavi IN/OUT
Sheath+StripLED+Closed caps+10 Brackets+IN/OUT cables

CODICE: CODE:	CCT (K)	W/m	Flusso in uscita (lm): Flow out (lm)	Intervallo taglio (mm): Cutting range (mm):
05888	Bianco 2700K White 2700K	14,9	1174	83,33
05887	Bianco 3000K White 3000K	14,9	1252	83,33
05886	Bianco 4000K White 4000K	14,9	1342	83,33
05885	Bianco 5800K White 5800K	14,9	1512	83,33
06599-D	Bianco dinamico Dynamic white	14,4	600	100,00
06599-H	RGB	14,4		100,00

CRI:
Ra>90

Durata utile:
Useful lifespan:
L70 B50 = 60.000h

Tolleranza cromatica:
Tolerance chromatic:
3 SDCM

CODICI COMPONENTI SINGOLI: SINGLE COMPONENTS CODES:

TAPPI
CAPS
CODICE
CODE
14717 / 14718
Passacavo/chiuso
Grommet/closed

FISSAGGIO
FIXING
CODICE
CODE
14695
Staffa di fissaggio 13xH24,5xL30mm
Fixing bracket 13xH24,5xL30mm
14695-L20
Profilo di fissaggio L=2000mm
Fixing profile L=2000mm



STRIPLED COMPATIBILI PER CUSTOMIZZAZIONE*: STRIPLED COMPATIBLE FOR CUSTOMIZATION*:

PROFESSIONAL
IP20 4,9W / 9,9W / 14,9W / 19,9W / 8,5W / 16W / 24,5W

PAGINA:
PAGE:
da 34 a 45

SCENOGRAPHIC
IP20 DW / RGB / RGB+W

PAGINA:
PAGE:
da 88 a 98

BUSINESS
IP20 6,5W / 12,5W / 17,5W

da 48 a 52

SPECIAL
IP20 11W / 12W

da 74 a 82

NEONFLEX 0612

movimento orizzontale
horizontal movement



Scheda tecnica
Datasheet

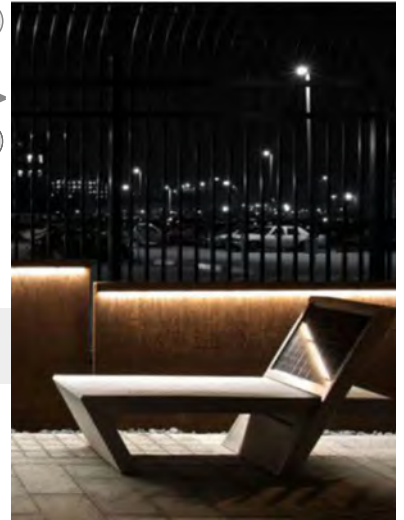
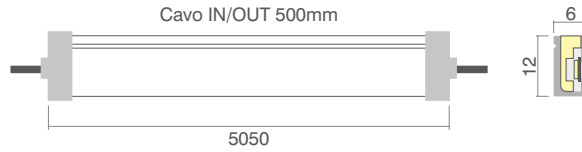
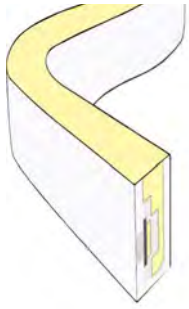

misure in mm / measurements in mm

POSSIBILITA' CUSTOMIZZAZIONE FINO 5m*
POSSIBILITY OF CUSTOMIZATION UP TO 5m*

CE IP65

Guaina+StripLED+Tappi chiusi+10 Staffe+cavi IN/OUT
Sheath+StripLED+Closed caps+10 Brackets+IN/OUT cables

CODICE: CODE:	CCT (K)	W/m	Flusso in uscita (lm): Flow out (lm)	Intervallo taglio (mm): Cutting range (mm):
06146	Bianco 2700K White 2700K	14,9	1174	83,33
06168	Bianco 3000K White 3000K	14,9	1252	83,33
06169	Bianco 4000K White 4000K	14,9	1342	83,33
06227	Bianco 5800K White 5800K	14,9	1512	83,33

CRI:
Ra>90

Durata utile:
Useful lifespan:
L70 B50 = 60.000h

Tolleranza cromatica:
Tolerance chromatic:
3 SDCM

CODICI COMPONENTI SINGOLI: SINGLE COMPONENTS CODES:

TAPPI CAPS

CODICE
CODE

14827 / 14826
Passacavo/chiuso
Grommet/closed

FISSAGGIO FIXING



CODICE
CODE

14828
Staffa di fissaggio 8xH13,4xL20mm
Fixing bracket 8xH13,4xL20mm

STRIPLED COMPATIBILI PER CUSTOMIZZAZIONE*: STRIPLED COMPATIBLE FOR CUSTOMIZATION*:

PROFESSIONAL

IP20 4,9W / 9,9W / 14,9W / 19,9W / 8,5W / 13W / 16W / 24,5W

PAGINA: PAGE:

da 34 a 45

BUSINESS

IP20 6,5W / 12,5W / 17,5W

da 48 a 52

SPECIAL

IP20 11W / 12W

da 74 a 82

NEONFLEX 0410

movimento orizzontale
horizontal movement



Scheda tecnica
Datasheet

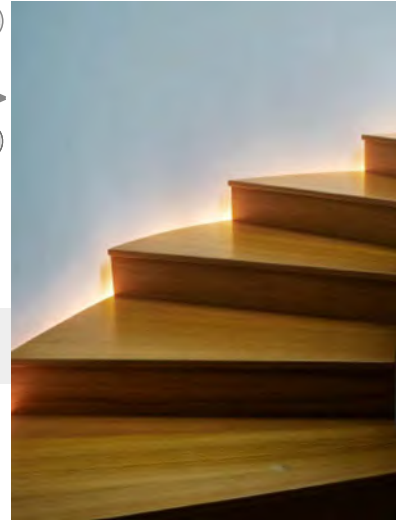
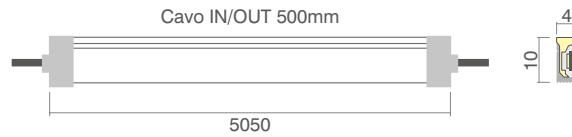
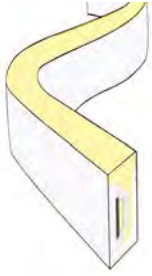

misure in mm / measurements in mm

POSSIBILITA' CUSTOMIZZAZIONE FINO 5m*
POSSIBILITY OF CUSTOMIZATION UP TO 5m*

CE IP65

Guaina+StripLED+Tappi chiusi+10 Staffe+cavi IN/OUT
Sheath+StripLED+Closed caps+10 Brackets+IN/OUT cables

CODICE: CODE:	CCT (K)	W/m	Flusso in uscita (lm): Flow out (lm)	Intervallo taglio (mm): Cutting range (mm):
------------------	---------	-----	---	--

06118	Bianco 2700K White 2700K	11	804	50,00
06119	Bianco 3000K White 3000K	11	834	50,00
06144	Bianco 4000K White 4000K	11	894	50,00
06145	Bianco 5800K White 5800K	11	984	50,00

CRI:
Ra>90

Durata utile:
Useful lifespan:
L70 B50 = 60.000h

Tolleranza cromatica:
Tolerance chromatic:
3 SDCM

CODICI COMPONENTI SINGOLI: SINGLE COMPONENTS CODES:

TAPPI CAPS

CODICE
CODE

14825 / 14824
Passacavo/chiuso
Grommet/closed

FISSAGGIO FIXING



CODICE
CODE

14823
Staffa di fissaggio 6xH12xL20mm
Fixing bracket 6xH12xL20mm

STRIPLED COMPATIBILI PER CUSTOMIZZAZIONE*:
STRIPLED COMPATIBLE FOR CUSTOMIZATION*:

PAGINA:
PAGE:

SPECIAL
IP20 11W

da 74 a 82

NEONFLEX 1010-S movimento orizzontale

horizontal movement



Scheda tecnica
Datasheet

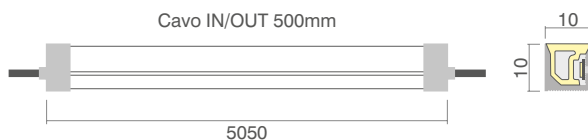
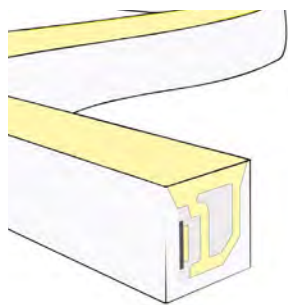

24 Vdc
IP65
5m

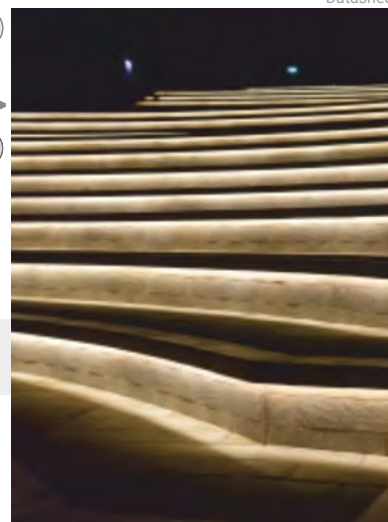

misure in mm / measurements in mm

POSSIBILITA' CUSTOMIZZAZIONE FINO 5m*
POSSIBILITY OF CUSTOMIZATION UP TO 5m*

CE IP65

Guaina+StripLED+Tappi chiusi+10 Staffe+cavi IN/OUT
Sheath+StripLED+Closed caps+10 Brackets+IN/OUT cables

CODICE: CODE:	CCT (K)	W/m	Flusso in uscita (lm): Flow out (lm)	Intervallo taglio (mm): Cutting range (mm):
------------------	---------	-----	---	--

06673	Bianco 2700K White 2700K	11	804	50,00
06674	Bianco 3000K White 3000K	11	834	50,00
06675	Bianco 4000K White 4000K	11	894	50,00
06676	Bianco 5800K White 5800K	11	984	50,00

CRI:
Ra>90

Durata utile:
Useful lifespan:
L70 B50 = 60.000h

Tolleranza cromatica:
Tolerance chromatic:
3 SDCM

CODICI COMPONENTI SINGOLI:

SINGLE COMPONENTS CODES:

TAPPI

CAPS

CODICE
CODE

14927 / 14926

Passacavo/chiuso
Grommet/closed

FISSAGGIO

FIXING



CODICE
CODE

14922

Staffa di fissaggio 12,4xH13xL20mm
Fixing bracket 12xH13xL20mm

STRIPLED COMPATIBILI PER CUSTOMIZZAZIONE*:
STRIPLED COMPATIBLE FOR CUSTOMIZATION*:

PAGINA:
PAGE:

SPECIAL
IP20 11W

da 74 a 82

NEONFLEX 1010-B movimento verticale

vertical movement



Scheda tecnica
Datasheet

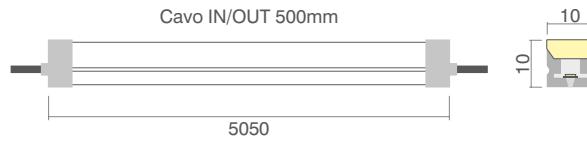
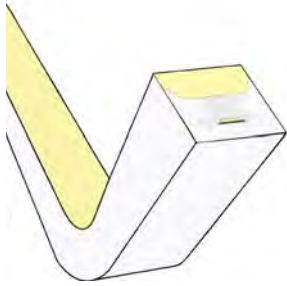

misure in mm / measurements in mm

POSSIBILITA' CUSTOMIZZAZIONE FINO 5m*
POSSIBILITY OF CUSTOMIZATION UP TO 5m*

CE IP65

Guaina+StripLED+Tappi chiusi+10 Staffe+cavi IN/OUT
Sheath+StripLED+Closed caps+10 Brackets+IN/OUT cables

CODICE: CODE:	CCT (K)	W/m	Flusso in uscita (lm): Flow out (lm)	Intervallo taglio (mm): Cutting range (mm):
06669	Bianco 2700K White 2700K	11	804	50,00
06670	Bianco 3000K White 3000K	11	834	50,00
06671	Bianco 4000K White 4000K	11	894	50,00
06672	Bianco 5800K White 5800K	11	984	50,00

CRI:
Ra>90

Durata utile:
Useful lifespan:
L70 B50 = 60.000h

Tolleranza cromatica:
Tolerance chromatic:
3 SDCM

CODICI COMPONENTI SINGOLI:

SINGLE COMPONENTS CODES:

TAPPI

CAPS

CODICE
CODE

14927 / 14926
Passacavo/chiuso
Grommet/closed

FISSAGGIO

FIXING



CODICE
CODE

14922
Staffa di fissaggio 12,4xH13xL20mm
Fixing bracket 12,4xH13xL20mm

STRIPLED COMPATIBILI PER CUSTOMIZZAZIONE*:
STRIPLED COMPATIBLE FOR CUSTOMIZATION*:

PAGINA:
PAGE:

SPECIAL
IP20 11W

da 74 a 82

Il gioco delle forme: la luce diventa sinuosa

The game of shapes: light becomes sinuous

La Neon Flex Tube permette di ottenere una luce a 360° morbida e flessibile, offrendo maggiore versatilità e possibilità di integrazione con altri elementi architettonici o decorativi.

Sono dotati di accessori specifici che garantiscono il grado di protezione e la sicurezza del prodotto. Ciò include accessori per il fissaggio, il collegamento e la protezione dei collegamenti elettrici.

The Neon Flex Tube provides a soft and flexible 360-degree light, offering greater versatility and integration with other architectural or decorative elements.

They come with specific accessories that ensure product protection and safety. This includes accessories for fastening, connecting, and protecting electrical connections.



Per ulteriori dettagli e informazioni sui nostri prodotti, vi invitiamo a contattarci direttamente.
To obtain further details and information about our products, we invite you to contact us directly.

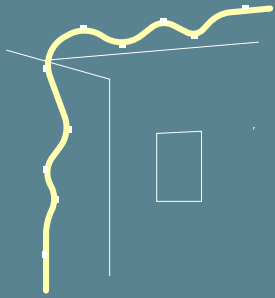

Applicazione a soffitto e parete

Horizontal and vertical ceiling installation

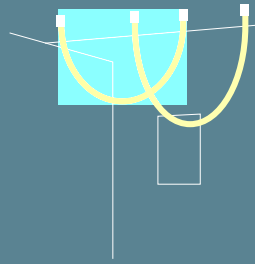

Doppia installazione a soffitto

Vertical ceiling-double installation

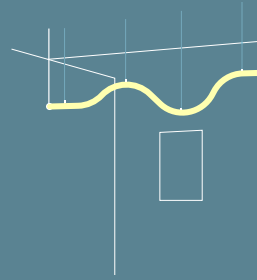

Installazione creativa sospesa

Creative vertical suspended installation

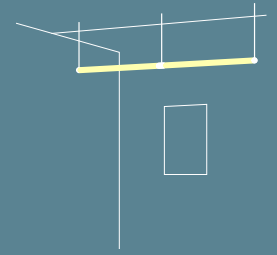

Installazione sospesa

Horizontal suspended installation

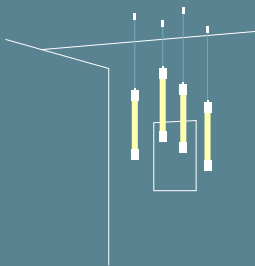

Applicazione sospesa verticale

Suspended vertical installation

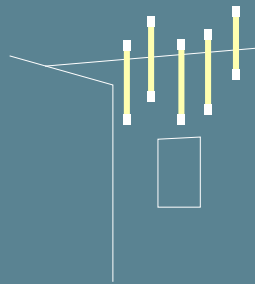

Installazione a plafone

Ceiling installation

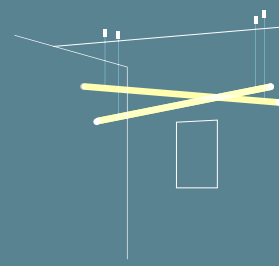

Installazione creativa sospesa lineare

Creative vertical linear suspended installation

NEONFLEX TUBE



Scheda tecnica
Datasheet

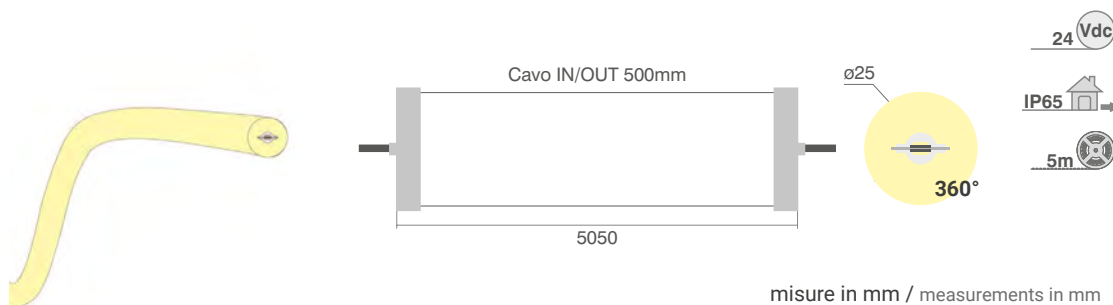

24 Vdc
IP65
5m

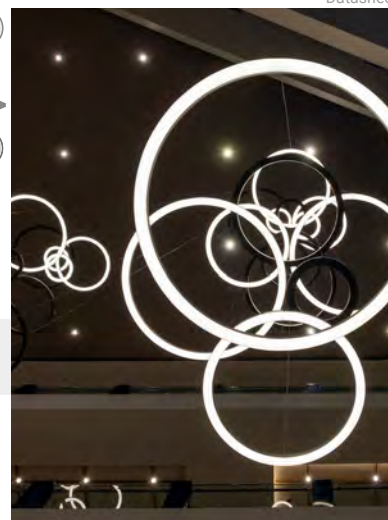

misure in mm / measurements in mm

POSSIBILITA' CUSTOMIZZAZIONE FINO 5m*
POSSIBILITY OF CUSTOMIZATION UP TO 5m*

CE IP65

Guaina+StripLED+Tappi chiusi+10 Staffe+cavi IN/OUT
Profile+Diffuser+Caps (1 closed and 1 open)+Clip

CODICE: CODE:	CCT (K)	W/m	Flusso in uscita (lm): Flow out (lm)	Intervallo taglio (mm): Cutting range (mm):
------------------	---------	-----	---	--

06642-L50	Bianco 2700K White 2700K	25	2016	
06643-L50	Bianco 3000K White 3000K	25	2040	
06644-L50	Bianco 4000K White 4000K	25	2160	
06645-L50	Bianco 5800K White 5800K	25	2376	

sezionabile solo
da addetti Elcom

CRI:
Ra>90

Durata utile:
Useful lifespan:
L70 B50 = 60.000h

Tolleranza cromatica:
Tolerance chromatic:
3 SDCM

CODICI COMPONENTI SINGOLI: SINGLE COMPONENTS CODES:

TAPPI

CAPS

CODICE
CODE

14916- / 14915-

Passacavo/chiuso
Grommet/closed

FISSAGGIO

FIXING

CODICE
CODE

14914

Molletta di fissaggio trasparente 28xH24,5mm
Transparent fixing clip 28xH24,5mm



STRIPLED COMPATIBILI PER CUSTOMIZZAZIONE*: STRIPLED COMPATIBLE FOR CUSTOMIZATION*:

PROFESSIONAL

IP20 4,9W / 9,9W / 14,9W / 19,9W / 8,5W / 16W / 24,5W

PAGINA:
PAGE:

da 34 a 45

SCENOGRAPHIC

IP20 DW / RGB / RGB+W

PAGINA:
PAGE:

da 88 a 98

BUSINESS

IP20 6,5W / 12,5W / 17,5W

da 48 a 52

SPECIAL

IP20 11W / 12W

da 74 a 82





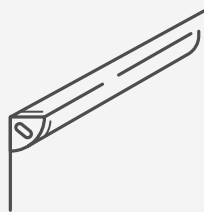

Profili

profiles

Siamo in grado di fornire profili personalizzati e su misura per ospitare una vasta gamma di StripLED, grazie al nostro collaudato processo produttivo e ai macchinari di taglio all'avanguardia.

Offriamo la soluzione di illuminazione ideale per ogni esigenza.

Thanks to our proven manufacturing process and state-of-the-art cutting machines, we are able to provide customized and tailor-made profiles to host a wide range of LED strips.

We offer the ideal lighting solution for every need.

Quando il design incontra la sicurezza

When design meets safety

I profili dedicati all'illuminazione a LED offrono una vasta gamma di funzionalità, consentendo di realizzare progetti e soluzioni architettoniche di alto livello, senza sacrificare la praticità e la sicurezza. Inoltre, svolgono un ruolo fondamentale nella dissipazione del calore generato dalle StripLED e nella loro protezione da urti e umidità, in conformità con la classificazione IP.

I nostri profili sono forniti con diversi tipi di coperture: opale, trasparente, prismatico oppure con ottiche specifiche per alcuni profili. Sono disponibili tre finiture standard: alluminio, bianco e nero; su richiesta sono disponibili finiture su tabella RAL.

The profiles for LED lighting offer a wide range of features, allowing the creation of high-level architectural projects and solutions without compromising practicality and safety. Additionally, they play a fundamental role in dissipating the heat generated by LED strips and in protecting them from shocks and moisture, in accordance with the IP classification. Our profiles are supplied with different types of covers: opal, transparent, prismatic or with specific optics for some profiles. Three standard finishes are available: aluminium, white and black; on request they are available on RAL table.



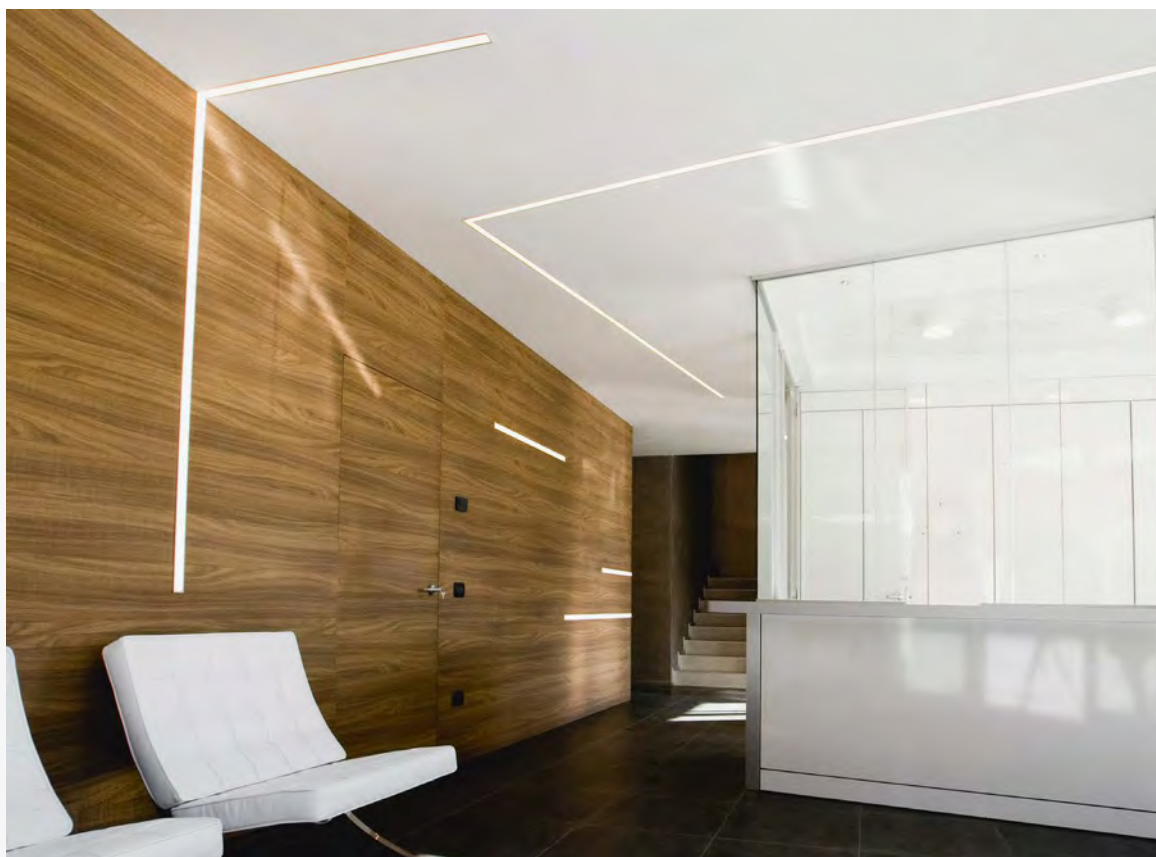

Le soluzioni proposte variano per forma, materiale e tipo di installazione, con un unico comune denominatore: **la qualità del Made in Italy.**

DRYWALL

per installazione su cartongesso

TERMOPLASTICI

la scelta green

ECO

profili adatti ad ogni progetto

PLAFONE

per applicazione a superficie, soffitti o pareti

ANGOLARE

per illuminazione ad angolo

INCASSI A BATTUTA / A RASO

la scelta ideale per soluzioni di arredo eleganti

XPS

quando si cercano soluzioni architettoniche particolari

ESTERNO

profili con elevata protezione IP

The proposed solutions vary in shape, material, and installation type, with a unique common denominator: **the quality of Made in Italy.**

DRYWALL

for installation on plasterboard

THERMOPLASTICS

the green choice

ECO

profiles suitable for any project

CEILING

for surface application, ceilings, or walls

ANGULAR

for corner lighting

RECESSED WITH OVERLAY / TRIMLESS

the ideal choice for elegant furnishing solutions

XPS

when seeking particular architectural solutions

EXTERIOR

profiles with high IP protection

Profili / Profiles

Index

1. Termoplastico

Thermoplastic

	Pag.
1710 TP	132
1912 TP	133
2020 TP	134
2612 TP	135

2. Eco

	Pag.
38 Surface	138
42 Surface Low	139
43 Surface	140
40 Corner	141
39 Recessed	142
45 Recessed	143
44 Recessed Trimless	144

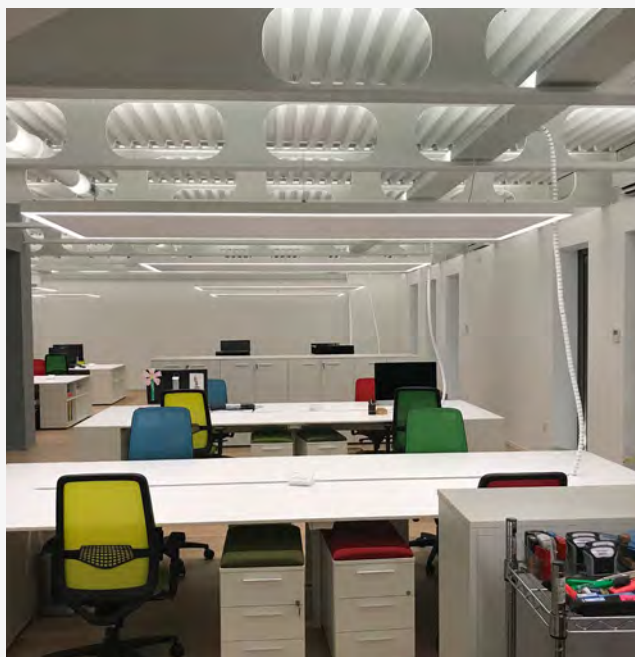

3. Plafone

Ceiling

	Pag.
0808	148
1508/1510	149
1805 FLEX	150
1807T Tesata	151
1813	152
1912	154
2421	155
3031	156
4817	158
4731	160
3546	162
5690	163
1828	164
2743	165
2027	166
7336	167
5634	168
2110	169
5015	170
4317	171
D20	172
D40	173

4. Angolare

Angular

	Pag.
1010	176
1616	177
2020	178
2115	179
7676	180
6730	181

5. Incassi in battuta

Recessed with trim

	Pag.
1914	184
2612	185
2711	186
4240	187
6635	188
5814	189
3537	190

6. Drywalls

	Pag.
1707	194
3011	195

7. Incassi a raso

Recessed flush/trimless

	Pag.
4812	198
5319	199
6212	200
6214	201
6414	202
8819	203
9819	204
2351	206
2646	207
3630	208
6137	209
3596	210
9536	211
4216	212
4219	213
7454	214
13664	215

8. XPS, PU, EPS

	Pag.
16560 XPS	218
15558 XPS	219
13090 XPS	220
10060 XPS	221
95095 XPS	222
12040 XPS	223
75036 PU	224
11515 PU	225
25014 EPS	226
28055 EPS	227
27055 EPS	228
15030 EPS	229
25090 EPS	230

9. Esterno

Outdoor

	Pag.
PROLINE 25 - STRIPLED	234
PROLINE 25 - OTTICHE	235
7234	236

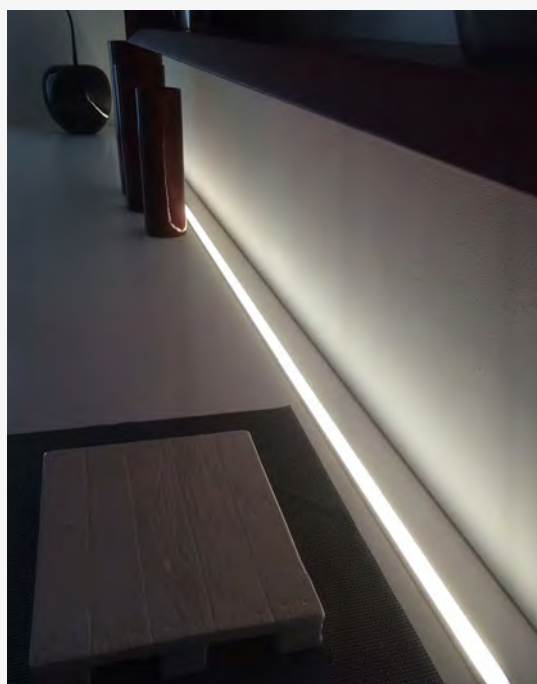

Termoplastico

Thermoplastic

I profili minimali in materiale termoplastico estruso sono adatti per diverse applicazioni e contesti d'uso, offrendo vantaggi ecologici. Garantiscono un colore uniforme anche sui punti di taglio e sono disponibili in finiture bianche o nere. Questi profili sono rapidi da installare e possono essere facilmente tagliati, anche con l'uso di un cutter. La loro leggerezza e flessibilità li rendono estremamente convenienti.

Minimal profiles made of extruded thermoplastic material, suitable for various applications and contexts. They provide a uniform color even at cutting points, with finishes available in white or black. Quick to install and cut, even with the use of a cutter, they are lightweight and flexible.





La scelta eco-sostenibile

The Green Choice



Un aspetto importante è la resistenza dei profili in termoplastico alle condizioni climatiche avverse, poiché non si ossidano. Di conseguenza, rappresentano la soluzione ideale per applicazioni in ambienti soggetti a nebbia salina. Con l'impiego di questi profili, oltre a beneficiare delle loro proprietà ecologiche, puoi ottenere risultati performanti anche in situazioni ambientali impegnative.

Thermoplastic profiles are ideal in environments with adverse weather conditions: they do not oxidize, making them the best solution for outdoor applications exposed to salt spray. By using these thermoplastic profiles, besides benefiting from their eco-friendly properties, you can achieve high performance even in challenging environmental situations.

PROFILO 1710TP Termoplastico



Scheda tecnica
Datasheet



Diffusore
Opale
Opal diffuser

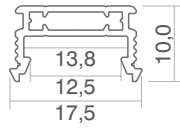

misure in mm / measurements in mm

Bianco
White Nero
Black

LUNGHEZZA MASSIMA: 4m
MAXIMUM LENGTH: 4m

CE IP20

COMPOSIZIONE CODICE KIT
KIT CODE COMPOSITION

Profilo+Diffusore+Tappi (1 chiuso e 1 aperto)+2 Mollette/mt
Profile+Diffuser+Caps (1 closed and 1 open)+2 Clips/mt

COD.BASE
BASE CODE:

1710TP-

DIFFUSORE
DIFFUSER

O (opale/opal)
T (trasparente/transparent)

FINITURA
FINISH

01 (bianco/white)
02 (nero/black)

LUNGHEZZA
LENGTH

L20 (2000mm)
L40 (4000mm)

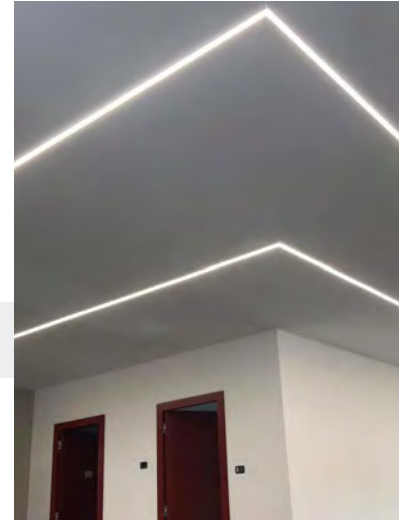

Configuratore di riferimento:
Reference configurator:

Es: 1710TP-001L20

OPZIONALE

OPTIONAL

03102

PIR SMD 12~24V

14071

TOUCH SMD 12~24V



SERVIZIO DI TAGLIO SU MISURA:

Per informazioni più dettagliate
sul servizio di taglio vedi pag. 230

CUSTOM CUT SERVICE:

For more detailed information
on the cutting service see page 230

PROFILO 1912TP Termoplastico



Scheda tecnica
Datasheet

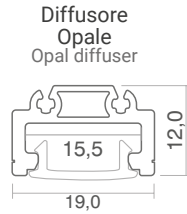

Diffusore
Opale
Opal diffuser

misure in mm / measurements in mm

Bianco
White Nero
Black

LUNGHEZZA MASSIMA: 4m
MAXIMUM LENGTH: 4m

CE IP20

COMPOSIZIONE CODICE KIT KIT CODE COMPOSITION

Profilo+Diffusore+Tappi (1 chiuso e 1 aperto)+2 Mollette/mt
Profile+Diffuser+Caps (1 closed and 1 open)+2 Clips/mt

COD.BASE
BASE CODE:

1912TP-

DIFFUSORE
DIFFUSER

O (opale/opal)
T (trasparente/transparent)

FINITURA
FINISH

01 (bianco/white)
02 (nero/black)

LUNGHEZZA
LENGTH

L20 (2000mm)
L40 (4000mm)



Configuratore di riferimento:
Reference configurator:

Es: 1912TP-001L20

OPZIONALE

OPTIONAL

03102

PIR SMD 12~24V

14071

TOUCH SMD 12~24V



SERVIZIO DI TAGLIO SU MISURA:

Per informazioni più dettagliate
sul servizio di taglio vedi pag. 230

CUSTOM CUT SERVICE:

For more detailed information
on the cutting service see page 230

PROFILO 2020TP Termoplastico

Angolare
Angular

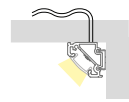

Scheda tecnica
Datasheet



Diffusore
Opale
Opal diffuser

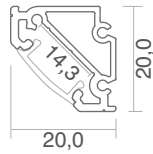

misure in mm / measurements in mm

Bianco
White Nero
Black

LUNGHEZZA MASSIMA: 4m
MAXIMUM LENGTH: 4m

CE IP20

COMPOSIZIONE CODICE KIT
KIT CODE COMPOSITION

Profilo+Diffusore+Tappi (1 chiuso e 1 aperto)+2 Mollette/mt
Profile+Diffuser+Caps (1 closed and 1 open)+2 Clips/mt

COD.BASE
BASE CODE:

2020TP-

DIFFUSORE
DIFFUSER

O (opale/opal)
T (trasparente/transparent)

FINITURA
FINISH

01 (bianco/white)
02 (nero/black)

LUNGHEZZA
LENGTH

L20 (2000mm)
L40 (4000mm)

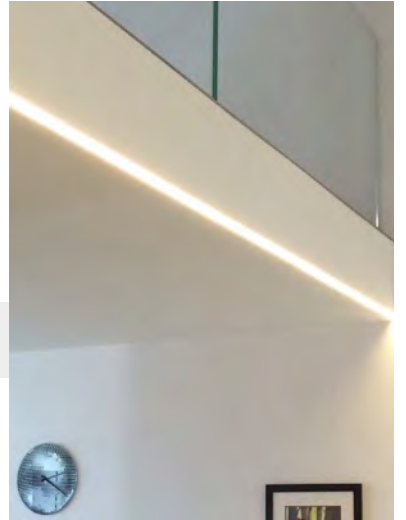

Configuratore di riferimento:
Reference configurator:

Es: 2020TP-001L20

OPZIONALE

OPTIONAL

03102

PIR SMD 12~24V

14071

TOUCH SMD 12~24V



SERVIZIO DI TAGLIO SU MISURA:

Per informazioni più dettagliate
sul servizio di taglio vedi pag. 230

CUSTOM CUT SERVICE:

For more detailed information
on the cutting service see page 230

PROFILO 2612TP Termoplastico

Plafone
Ceiling-wall



Scheda tecnica
Datasheet

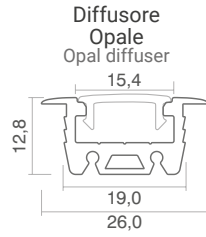

misure in mm / measurements in mm

Bianco
White Nero
Black

LUNGHEZZA MASSIMA: 4m
MAXIMUM LENGTH: 4m

CE IP20

COMPOSIZIONE CODICE KIT
KIT CODE COMPOSITION

Profilo+Diffusore+Tappi (1 chiuso e 1 aperto)+2 Mollette/mt
Profile+Diffuser+Caps (1 closed and 1 open)+2 Clips/mt

COD.BASE
BASE CODE:

2612TP-

DIFFUSORE
DIFFUSER

O (opale/opal)
T (trasparente/transparent)

FINITURA
FINISH

01 (bianco/white)
02 (nero/black)

LUNGHEZZA
LENGTH

L20 (2000mm)
L40 (4000mm)

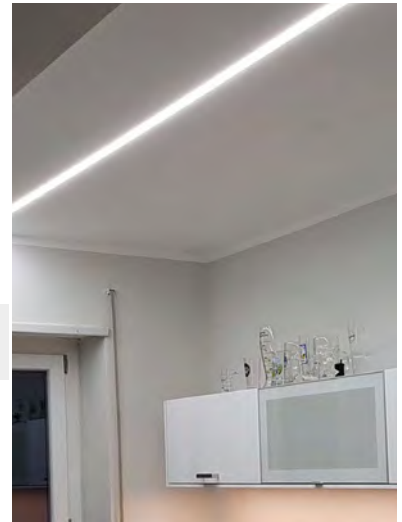

Configuratore di riferimento:
Reference configurator:

Es: 2612TP-001L40

OPZIONALE

OPTIONAL

03102

PIR SMD 12~24V

14071

TOUCH SMD 12~24V



SERVIZIO DI TAGLIO SU MISURA:

Per informazioni più dettagliate
sul servizio di taglio vedi pag. 230

CUSTOM CUT SERVICE:

For more detailed information
on the cutting service see page 230



Eco

I profili di illuminazione in alluminio alleggerito sono strutture progettate per ospitare e nascondere strisce LED o altre fonti di illuminazione, garantendo un'illuminazione diretta o indiretta, diffusa e uniforme negli ambienti interni. Questa soluzione offre contemporaneamente un aspetto moderno e discreto. Questi profili trovano impiego in un'ampia varietà di contesti, inclusi interni domestici, negozi, uffici, ristoranti, spazi commerciali e anche nell'ambito dell'illuminazione decorativa esterna. Con l'evoluzione continua della tecnologia dell'illuminazione, il mercato offre una vasta gamma di opzioni, ognuna con caratteristiche specifiche in grado di soddisfare le diverse esigenze e preferenze di progettisti e clienti.

Lightweight aluminum lighting profiles are structures designed to host and hide LED strips or other lighting sources, ensuring direct or indirect, diffused and uniform lighting in indoor environments. This solution simultaneously offers a modern and discreet appearance. These profiles are used in a wide variety of contexts, including domestic interiors, shops, offices, restaurants, commercial spaces and also as part of external decorative lighting. With the continuous evolution of lighting technology, the market offers a wide range of options, each with specific characteristics capable of satisfying the different needs and preferences of designers and customers.



Adatte ad ogni progetto

Suitable for every project



Le caratteristiche principali dei profili di illuminazione in alluminio alleggerito includono:

- **Design sottile e discreto** - Essi sono progettati con spessori ridotti e linee pulite per integrarsi facilmente nell'architettura e nell'arredamento degli spazi.
- **Protezione delle strisce LED** - I profili in alluminio forniscono una protezione meccanica per le strisce LED, riducendo il rischio di danni fisici e prolungando la loro vita utile.
- **Diffusione della luce** - Molti profili di illuminazione in alluminio sono dotati di coperture opali che aiutano a diffondere la luce emessa dalle strisce LED, creando un'illuminazione più uniforme e piacevole agli occhi.
- **Facilità di installazione** - I profili di illuminazione in alluminio alleggerito sono progettati per essere facili da montare e fissare a pareti, soffitti o altre superfici.
- **Varie forme e dimensioni** - Sono disponibili diverse forme e dimensioni di profili per adattarsi a diverse esigenze di progettazione e per consentire l'installazione in diverse situazioni.

The main features of the lightened aluminum lighting profiles include:

- **Slim and discreet design** - They are designed with reduced thicknesses and clean lines to easily integrate into the architecture and furnishings of the spaces.
- **Protection of LED Strips** - Aluminum profiles provide mechanical protection for LED strips, reducing the risk of physical damage and extending their useful life.
- **Light Diffusion** - Many aluminum lighting profiles feature opal covers that help diffuse the light emitted by the LED strips, creating a more uniform and pleasing to the eye lighting.
- **Ease of installation** - Lightweight aluminum lighting profiles are designed to be easy to fit and secure to walls, ceilings or other surfaces.
- **Various shapes and sizes** - Different shapes and sizes of profiles are available to fit different design needs and to allow for installation in different situations.

PROFILO 38 SURFACE

Plafone
Ceiling-wall

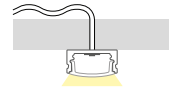

Scheda tecnica
Datasheet



Diffusore
Opale
Opal diffuser

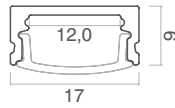

misure in mm / measurements in mm

Alluminio anodizzato
Anodized aluminum

Bianco
White

LUNGHEZZA MASSIMA: 2m
MAXIMUM LENGTH: 2m

CE IP20

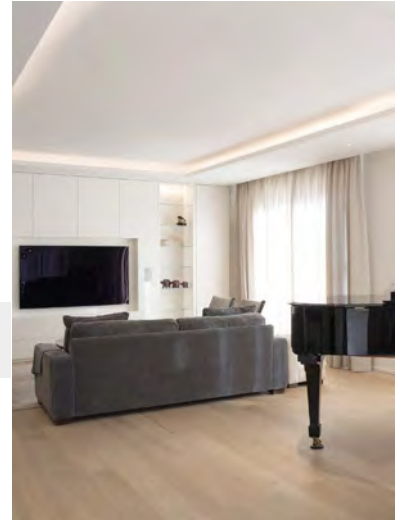

COMPOSIZIONE CODICE KIT KIT CODE COMPOSITION

20 Profilo+Diffusore+4 Tappi di chiusura+4 Mollette
Profile+Diffuser+4 Closing caps + 4 Clips

CODICE
CODE:

DIFFUSORE 
DIFFUSER

LUNGHEZZA 
LENGTH

FINITURA 
FINISH

K7382-S04-4262

Opale / Opal

L=2000mm

Anodizzato / Anodized

K7382-S04-3162

Opale / Opal

L=2000mm

Bianco / White

OPZIONALE

OPTIONAL

84-90380-51

Kit di ricambio con 4 molle di fissaggio e 4 tappi di chiusura grigi (2+2)
Spare kit with 4 fixing springs and 4 gray closing caps (2+2)

84-90380-31

Kit di ricambio con 4 molle di fissaggio e 4 tappi di chiusura bianchi (2+2)
Spare kit with 4 fixing springs and 4 white closing caps (2+2)

PROFILO 42 SURFACE LOW



Scheda tecnica
Datasheet

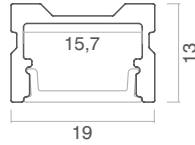

misure in mm / measurements in mm

Alluminio anodizzato
Anodized aluminum

Bianco
White

LUNGHEZZA MASSIMA: 2m
MAXIMUM LENGTH: 2m

CE IP20

COMPOSIZIONE CODICE KIT KIT CODE COMPOSITION

12 Profilo+Diffusore+4 Tappi di chiusura+4 Mollette
Profile+Diffuser+4 Closing caps + 4 Clips

CODICE
CODE:

K7422-04-4262

K7422-04-3162

DIFFUSORE 
DIFFUSER

Opale / Opal

Opale / Opal

LUNGHEZZA 
LENGTH

L=2000mm

L=2000mm

FINITURA 
FINISH

Anodizzato / Anodized

Bianco / White

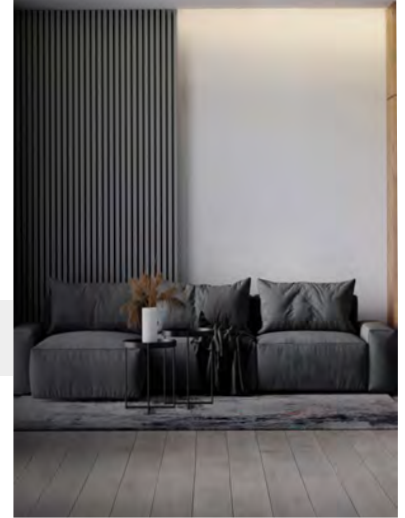

OPZIONALE

OPTIONAL

84-90420-51

Kit di ricambio con 4 molle di fissaggio e 4 tappi di chiusura grigi (2+2)
Spare kit with 4 fixing springs and 4 gray closing caps (2+2)

84-90420-31

Kit di ricambio con 4 molle di fissaggio e 4 tappi di chiusura bianchi (2+2)
Spare kit with 4 fixing springs and 4 white closing caps (2+2)

PROFILO 43 SURFACE

Plafone
Ceiling-wall

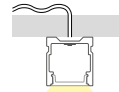

Scheda tecnica
Datasheet

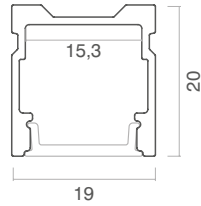

misure in mm / measurements in mm

Alluminio anodizzato
Anodized aluminum

Bianco
White

LUNGHEZZA MASSIMA: 2m
MAXIMUM LENGTH: 2m

CE IP20



COMPOSIZIONE CODICE KIT KIT CODE COMPOSITION

12 Profilo+Diffusore+4 Tappi di chiusura+4 Mollette
Profile+Diffuser+4 Closing caps + 4 Clips

CODICE
CODE:

K7432-04-4262

K7432-04-3162

DIFFUSORE 
DIFFUSER

Opale / Opal

Opale / Opal

LUNGHEZZA 
LENGTH

L=2000mm

L=2000mm

FINITURA 
FINISH

Anodizzato / Anodized

Bianco / White

OPZIONALE

OPTIONAL

84-90430-51

Kit di ricambio con 4 molle di fissaggio e 4 tappi di chiusura grigi (2+2)
Spare kit with 4 fixing springs and 4 gray closing caps (2+2)

84-90430-31

Kit di ricambio con 4 molle di fissaggio e 4 tappi di chiusura bianchi (2+2)
Spare kit with 4 fixing springs and 4 white closing caps (2+2)

PROFILO 40 CORNER

Angolare
Angular



Scheda tecnica
Datasheet

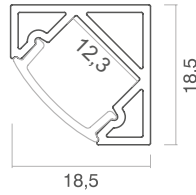

misure in mm / measurements in mm

Alluminio anodizzato
Anodized aluminum

Bianco
White

LUNGHEZZA MASSIMA: 2m
MAXIMUM LENGTH: 2m

CE IP20



COMPOSIZIONE CODICE KIT KIT CODE COMPOSITION

10 Profilo+Diffusore+4 Tappi di chiusura+4 Mollette
Profile+Diffuser+4 Closing caps + 4 Clips

CODICE
CODE:

K7402-C04-4262

K7402-C04-3162

DIFFUSORE 
DIFFUSER

Opale / Opal

Opale / Opal

LUNGHEZZA 
LENGTH

L=2000mm

L=2000mm

FINITURA 
FINISH

Anodizzato / Anodized

Bianco / White

OPZIONALE

OPTIONAL

84-90400-51

Kit di ricambio con 4 molle di fissaggio e 4 tappi di chiusura grigi (2+2)
Spare kit with 4 fixing springs and 4 gray closing caps (2+2)

84-90400-31

Kit di ricambio con 4 molle di fissaggio e 4 tappi di chiusura bianchi (2+2)
Spare kit with 4 fixing springs and 4 white closing caps (2+2)

PROFILO 39 RECESSED



Scheda tecnica
Datasheet

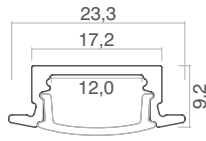

misure in mm / measurements in mm

Alluminio anodizzato
Anodized aluminum

Bianco
White

LUNGHEZZA MASSIMA: 2m
MAXIMUM LENGTH: 2m

CE IP20



COMPOSIZIONE CODICE KIT KIT CODE COMPOSITION

20 Profilo+Diffusore+4 Tappi di chiusura+4 Mollette
Profile+Diffuser+4 Closing caps + 4 Clips

CODICE
CODE:

DIFFUSORE 
DIFFUSER

LUNGHEZZA 
LENGTH

FINITURA 
FINISH

K7392-R04-4262

Opale / Opal

L=2000mm

Anodizzato / Anodized

K7392-R04-3162

Opale / Opal

L=2000mm

Bianco / White

OPZIONALE

OPTIONAL

84-90390-51

Kit di ricambio con 4 molle di fissaggio e 4 tappi di chiusura grigi (2+2)
Spare kit with 4 fixing springs and 4 gray closing caps (2+2)

84-90390-31

Kit di ricambio con 4 molle di fissaggio e 4 tappi di chiusura bianchi (2+2)
Spare kit with 4 fixing springs and 4 white closing caps (2+2)

PROFILO 45 RECESSED



Incasso
Recessed



Scheda tecnica
Datasheet

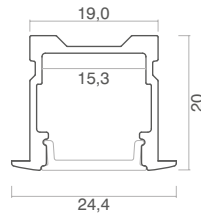

misure in mm / measurements in mm

Alluminio anodizzato
Anodized aluminum

Bianco
White

Nero
Black

LUNGHEZZA MASSIMA: 2m
MAXIMUM LENGTH: 2m

CE IP20

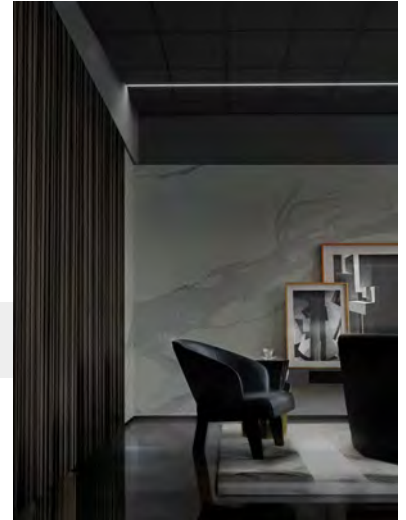

COMPOSIZIONE CODICE KIT KIT CODE COMPOSITION

12 Profilo+Diffusore+4 Tappi di chiusura+4 Mollette
Profile+Diffuser+4 Closing caps + 4 Clips

CODICE
CODE:

DIFFUSORE 
DIFFUSER

LUNGHEZZA 
LENGTH

FINITURA 
FINISH

K7452-04-4262

Opale / Opal

L=2000mm

Anodizzato / Anodized

K7452-04-3162

Opale / Opal

L=2000mm

Bianco / White

K7452-04-1262

Opale / Opal

L=2000mm

Nero / Black

OPZIONALE

OPTIONAL

84-90450-51

Kit di ricambio con 4 molle di fissaggio e 4 tappi di chiusura grigi (2+2)
Spare kit with 4 fixing springs and 4 gray closing caps (2+2)

84-90450-31

Kit di ricambio con: 4 ganci di fissaggio e 4 tappi di chiusura bianchi (2+2)
Spare kit with 4 fixing springs and 4 white closing caps (2+2)

84-90450-30

Kit di ricambio con: 4 ganci di fissaggio e 4 tappi di chiusura neri (2+2)
Spare kit with 4 fixing springs and 4 black closing caps (2+2)

PROFILO 44 RECESSED TRIMLESS

Incasso a raso
Flush recessed



Scheda tecnica
Datasheet

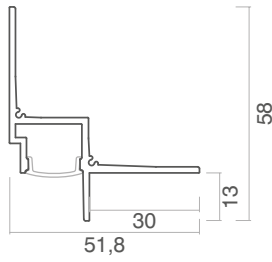

misure in mm / measurements in mm

Bianco
White

LUNGHEZZA MASSIMA: 3m
MAXIMUM LENGTH: 3m

CE IP20

COMPOSIZIONE CODICE KIT
KIT CODE COMPOSITION

2 Profilo+Diffusore+4 Tappi di chiusura
Profile+Diffuser+4 Closing caps

CODICE
CODE:

DIFFUSORE 
DIFFUSER

LUNGHEZZA 
LENGTH

FINITURA 
FINISH

K7443-R04-3147

Semi-trasparente / Semi transparent

L=3000mm

Bianco / White

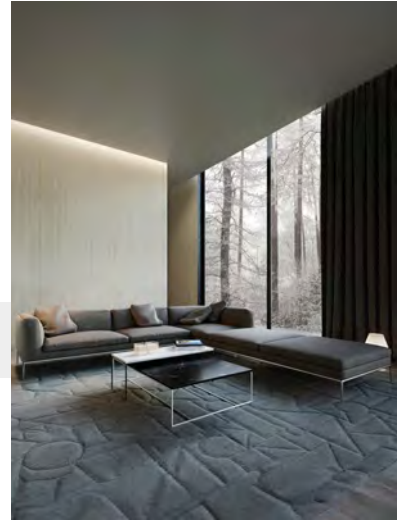





Plafone

Celing

I profili a superficie si integrano in modo impeccabile nell'architettura circostante, creando un mix perfetto di eleganza e semplicità che valorizza ogni progetto di interior design. Questi prodotti sono appositamente progettati per alloggiare le StripLED, offrendo un'illuminazione sofisticata e discreta.

Surface profiles seamlessly integrate with the surrounding architecture, creating a perfect blend of elegance and simplicity that enhances every interior design project. These products are specifically designed to accommodate LED Strips, offering sophisticated and discreet lighting solutions.

Applicazione a superficie

Surface application

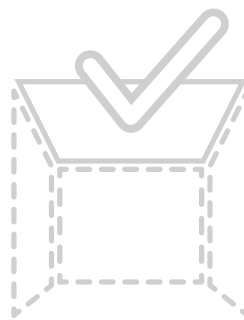

La loro versatilità li rende ideali per una vasta gamma di applicazioni in diversi contesti. Grazie alla loro eleganza e praticità, i profili di alluminio sono la scelta ideale per trasformare gli spazi in qualcosa di speciale, catturando lo sguardo e rendendo unico ogni ambiente.

Their versatility makes them ideal for a wide range of applications in different contexts. Thanks to their elegance and practicality, aluminum surface profiles are the perfect choice to transform spaces into something special, capturing attention and making each environment unique.

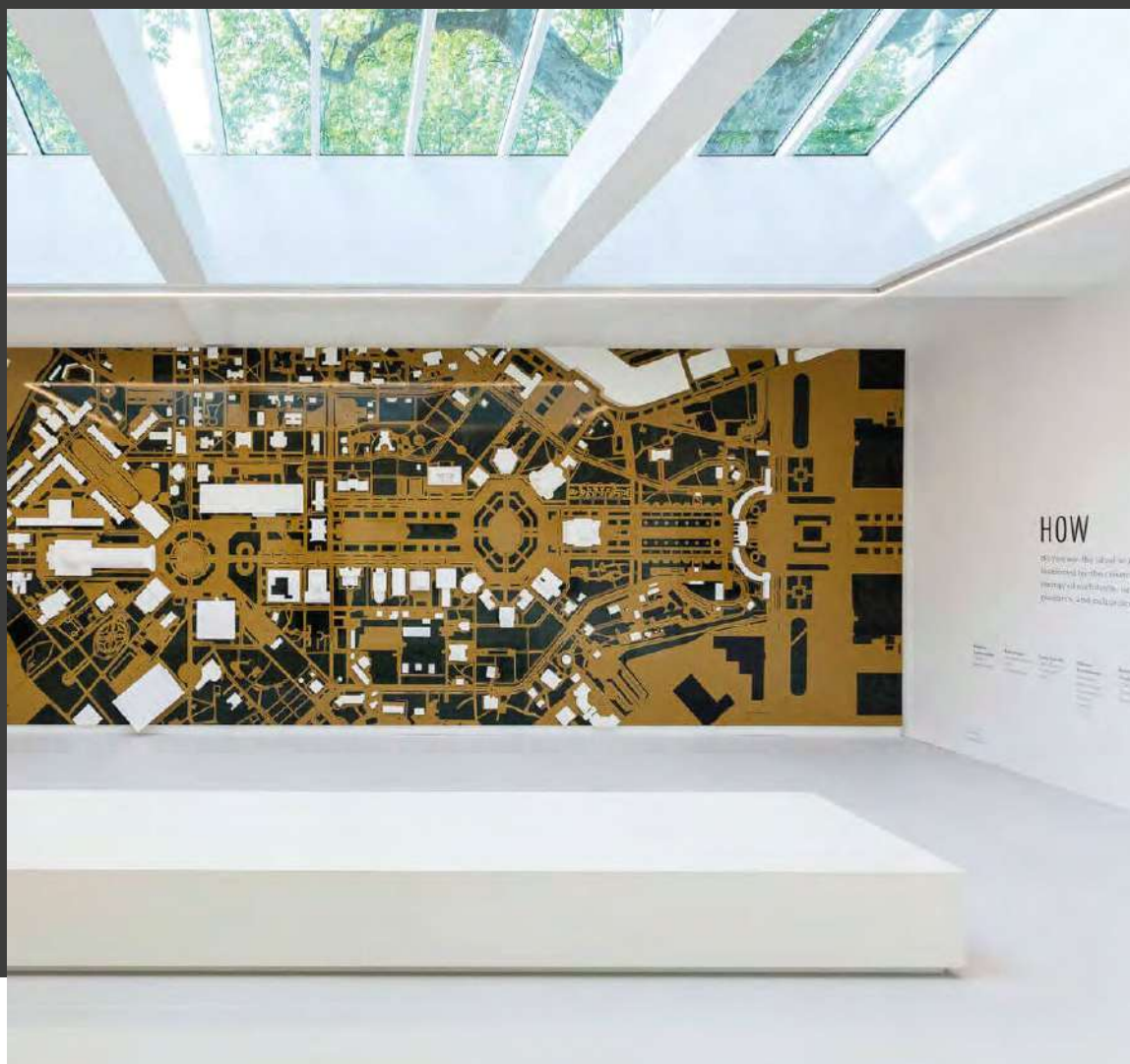

PROFILO 0808

Plafone
Ceiling-wall

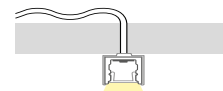

Scheda tecnica
Datasheet

**Compatibile solo
con Micro StripLED
da 4mm a pag.75**
Compatible only with
4mm Micro StripLED
on page 75

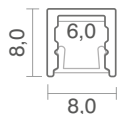

misure in mm / measurements in mm

Alluminio anodizzato
Anodized aluminum

Bianco
White

Nero
Black

LUNGHEZZA MASSIMA: 2m
MAXIMUM LENGTH: 2m

CE IP20

COMPOSIZIONE CODICE KIT KIT CODE COMPOSITION

Profilo+Diffusore+Tappi (1 chiuso e 1 aperto)+2 Mollette/mt
Profile+Diffuser+Caps (1 closed and 1 open)+2 Clips/mt

COD. BASE
BASE CODE:

DIFFUSORE
DIFFUSER



0808-

O (opale/opal)

FINITURA
FINISH



00 (alluminio/aluminium)
01 (bianco/white)
02 (nero/black)

LUNGHEZZA
LENGTH

L10 (1000mm)
L20 (2000mm)

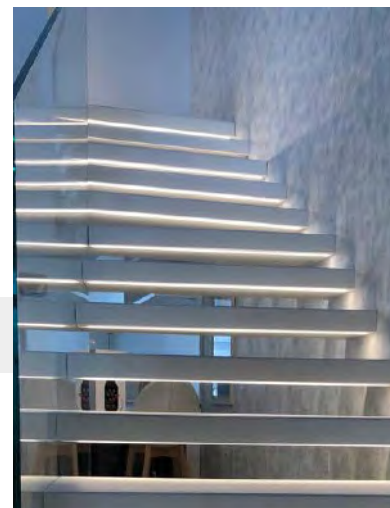

Configuratore di riferimento:
Reference configurator:
Es: 0808-001L20

CODICI COMPONENTI SINGOLI: SINGLE COMPONENTS CODES:

PROFILO
PROFILE



COD. BASE
BASE CODE

FINITURE
FINISH

L=

14719-

01
02

L10
L20

DIFFUSORE
DIFFUSER



COD. BASE
BASE CODE

L=

14727-
Opale
Opal

L10
L20

TAPPI
CAPS

COD. BASE
BASE CODE

14729- / 14730-
Passacavo/chiuso
Grommet/closed



FINITURE
FINISH

01
02

FISSAGGIO
FIXING

COD. BASE
BASE CODE

14777
Molletta
Clip



**Senza il codice della finitura il
profilo si intende in alluminio**
Without the finish code the
profile is made of aluminium

**Senza il codice della finitura i
tappi si intendono in alluminio**
Without the finish code i
caps are made of aluminium

OPZIONALE OPTIONAL



SERVIZIO DI TAGLIO SU MISURA:

Per informazioni più dettagliate
sul servizio di taglio vedi pag. 230
CUSTOM CUT SERVICE:

For more detailed information
on the cutting service see page 230

PROFILO 1508/1510



Scheda tecnica
Datasheet



1508 con adesivo
1508 with adhesive

1510 con molletta
1510 with clip

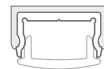
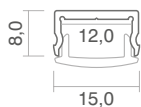

misure in mm / measurements in mm

Alluminio anodizzato
Anodized aluminum

LUNGHEZZA MASSIMA: 4m
MAXIMUM LENGTH: 4m

CE IP20

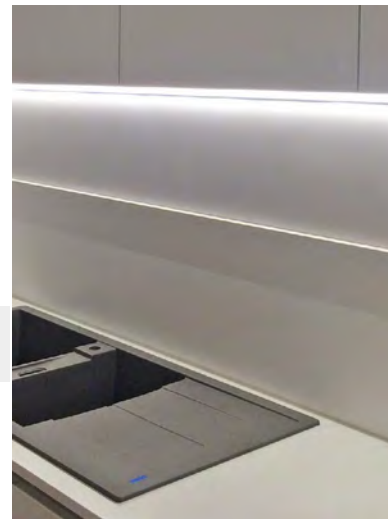

Configuratore di riferimento:
Reference configurator:

Es: 1510-000L20

COMPOSIZIONE CODICE KIT KIT CODE COMPOSITION

Profilo+Diffusore+Tappi (1 chiuso e 1 aperto)+2 Mollette/mt
Profile+Diffuser+Caps (1 closed and 1 open)+2 Clips/mt

COD.BASE
BASE CODE:

DIFFUSORE
DIFFUSER

1508- O (opale/opal)
1510- T (trasparente/transparent)
S (satinata/satin)

FINITURA
FINISH

00 (alluminio/aluminium)

LUNGHEZZA
LENGTH

L10 (1000mm)
L20 (2000mm)
L30 (3000mm)
L40 (4000mm)

1510 disponibile solo L20/L40 - 1510 available only L20/L40

1510 disponibile solo con diffusore opale e trasparente - 1510 available only with opal and transparent diffuser

CODICI COMPONENTI SINGOLI: SINGLE COMPONENTS CODES:

PROFILO
PROFILE
COD. BASE
BASE CODE
14285-

L=

L10
L20
L30
L40

DIFFUSORE
DIFFUSER
COD. BASE
BASE CODE

14000-
Trasparente
Transparent

14001-
Opale
Opal

14445-
Satinata
Satin

L=

L10
L20
L30
L40

TAPPI
CAPS
COD. BASE
BASE CODE
14249 / 14240
Passacavo a pressione/chiuso a pressione
Pressure grommet/pressure closed

FISSAGGIO
FIXING
COD. BASE
BASE CODE
14686
Molletta (1510)
Clip (1510)

OPZIONALE OPTIONAL

10075
Calamita adesivizzata 15x1,2mm (50m)
Adhesive magnet 15x1,2mm (50m)

14071
TOUCH SMD 12~24V



SERVIZIO DI TAGLIO SU MISURA:

Per informazioni più dettagliate
sul servizio di taglio vedi pag. 230

CUSTOM CUT SERVICE:

For more detailed information
on the cutting service see page 230

PROFILO 1805 - Flessibile Flexible

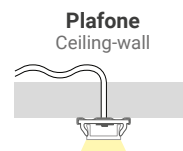

Scheda tecnica
Datasheet

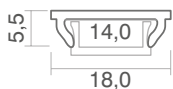

misure in mm / measurements in mm

Alluminio anodizzato
Anodized aluminum

Bianco
White

Nero
Black

LUNGHEZZA MASSIMA: 2m
MAXIMUM LENGTH: 2m

CE IP20

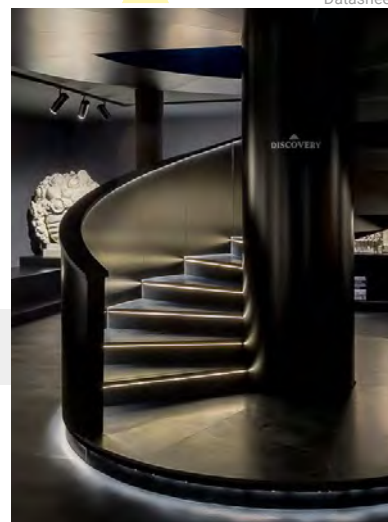

Configuratore di riferimento:
Reference configurator:

Es: 1805-002L20

COMPOSIZIONE CODICE KIT KIT CODE COMPOSITION

Profilo+Diffusore+Tappi (1 chiuso e 1 aperto)+2 Mollette/mt
Profile+Diffuser+Caps (1 closed and 1 open)+2 Clips/mt

COD.BASE
BASE CODE:
1805-

DIFFUSORE
DIFFUSER 
0 (opale/opal)

FINITURA
FINISH 
00 (alluminio/aluminium)
01 (bianco/white)
02 (nero/black)

LUNGHEZZA
LENGTH 
L10 (1000mm)
L20 (2000mm)

CODICI COMPONENTI SINGOLI: SINGLE COMPONENTS CODES:

PROFILO
PROFILE 
COD. BASE
BASE CODE
14674-

FINITURE
FINISH 
L=

01
02

L10
L20

DIFFUSORE
DIFFUSER 
COD. BASE
BASE CODE
14675-
Opale
Opal

L=

L10
L20

TAPPI
CAPS 
COD. BASE
BASE CODE
14677- / 14676-
Passacavo/chiuso
Grommet/closed

FINITURE
FINISH 
01
02

FISSAGGIO
FIXING 
COD. BASE
BASE CODE
14685
Molletta
Clip

Senza il codice della finitura il
profilo si intende in alluminio
Without the finish code the
profile is made of aluminium

Senza il codice della finitura i
tappi si intendono in alluminio
Without the finish code i
caps are made of aluminium

OPZIONALE OPTIONAL

10075
Calamita adesivizzata 15x1,2mm (50m)
Adhesive magnet 15x1,2mm (50m)



SERVIZIO DI TAGLIO SU MISURA:

Per informazioni più dettagliate
sul servizio di taglio vedi pag. 230
CUSTOM CUT SERVICE:

For more detailed information
on the cutting service see page 230

PROFILO 1807T - Tesata flessibile Flexible Stretched

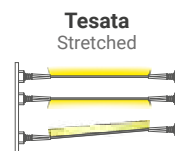

Scheda tecnica
Datasheet

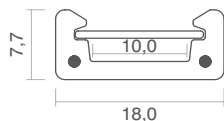

misure in mm / measurements in mm

TPV Nero
Black TPV

LUNGHEZZA MASSIMA: 5m
MAXIMUM LENGTH: 5m

CE IP20

COMPOSIZIONE CODICE KIT KIT CODE COMPOSITION

Profilo+Diffusore+Kit di montaggio
Profile+Diffuser+Mounting set

COD. BASE
BASE CODE:
1807T-

DIFFUSORE
DIFFUSER 
0 (opale/opal)

FINITURA
FINISH 
02 (nero/black)

LUNGHEZZA
LENGTH 
L05 (5000mm)



Configuratore di riferimento:
Reference configurator:

Es: 1807T-002L05

CODICI COMPONENTI SINGOLI: SINGLE COMPONENTS CODES:

PROFILO
PROFILE 
COD. BASE
BASE CODE
12026-

FINITURE
FINISH 
02

L=
L05

DIFFUSORE
DIFFUSER 
COD. BASE
BASE CODE
12027-
Opale
Opal

L=
L05

KIT DI MONTAGGIO
MOUNTING SET 
COD. BASE
BASE CODE
12028
Kit di montaggio composto da:
Mounting kit consisting of:
1) Kit di montaggio (metallo)
1) Mounting kit (metal)
2) Scatola decorativa (metallo + silicone)
2) Decorative box (metal + silicone)
3) Chiave inglese
3) Wrench key
4) Chiave a brugola
4) Allen key
5) Terminale
5) Terminal

1)  2)  3)  4)  5) 

OPZIONALE OPTIONAL

PROFILO 1813

Plafone
Ceiling-wall



Scheda tecnica
Datasheet



Diffusore
opale piano
Flat opal diffuser

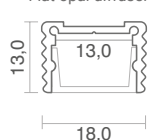

Diffusore
opale alto
High opal diffuser

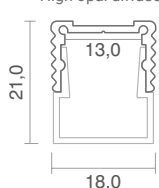

Diffusore
opale tondo
Round opal diffuser

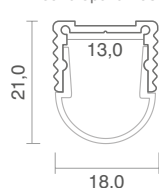

misure in mm / measurements in mm

Alluminio anodizzato
Anodized aluminum

Bianco
White

Nero
Black

LUNGHEZZA MASSIMA: 4m
MAXIMUM LENGTH: 4m

CE IP20

COMPOSIZIONE CODICE KIT KIT CODE COMPOSITION

Profilo+Diffusore+Tappi (1 chiuso e 1 aperto)+2 Mollette/mt
Profile+Diffuser+Caps (1 closed and 1 open)+2 Clips/mt

COD.BASE
BASE CODE:

1813-

DIFFUSORE
DIFFUSER

O (opale piano/flat opal)
PN (opale piano nero/flat black opal)
OT (opale tondo/round opal)
OA (opale alto/high opal)
P (prismatizzato UGR19/prismatic)

FINITURA
FINISH

00 (alluminio/aluminium)
01 (bianco/white)
02 (nero/black)

LUNGHEZZA
LENGTH

L10 (1000mm)
L20 (2000mm)
L30 (3000mm)
L40 (4000mm)



Configuratore di riferimento:
Reference configurator:

Es: 1813-001L30

CODICI COMPONENTI SINGOLI: SINGLE COMPONENTS CODES:

PROFILO
PROFILE

COD. BASE
BASE CODE

14178-

FINITURE
FINISH

L=

01
02

L10
L20
L30
L40

DIFFUSORE
DIFFUSER

COD. BASE
BASE CODE

14281-
Opale piano
Flat opal
14884-
Opale piano nero
Flat black opal
14655-
Prismatizzato
Prismatic
14016-
Opale tondo
Round opal
14929-
Opale alto
High opal

L=

L10
L20
L30
L40

TAPPI
CAPS

COD. BASE
BASE CODE

13210- / 13211-
Passacavo/chiuso
per diffusore 14281/14884/14655
Grommet/closed
for diffuser 14281/14884/14655
14231- / 14232-
Passacavo/chiuso
per diffusore 14016
Grommet/closed
for diffuser 14016
14212- / 14213-
Passacavo alto/chiuso alto
per diffusore 14929
Grommet/closed
for diffuser 14929

Senza il codice della finitura i
tappi si intendono in alluminio
Without the finish code i
caps are made of aluminium

FINITURE
FINISH

01
02

FISSAGGIO
FIXING

COD. BASE
BASE CODE

14419
Molletta fissa per
fissaggio a parete
Fixed clip for
wall fixing
14419-IF
Molletta angolare fissa per
fissaggio a parete
Fixed angular clip for
wall fixing
14998
Molletta orientabile per
fissaggio a parete
Adjustable clip for
wall fixing

Senza il codice della finitura il
profilo si intende in alluminio
Without the finish code the
profile is made of aluminium

OPZIONALE OPTIONAL

14071
TOUCH SMD 12~24V
(Disponibile solo con copertura piana)



SERVIZIO DI TAGLIO SU MISURA:

Per informazioni più dettagliate
sul servizio di taglio vedi pag. 230
CUSTOM CUT SERVICE:

For more detailed information
on the cutting service see page 230

PROFILO 1813 - APPROFONDIMENTO/Insight

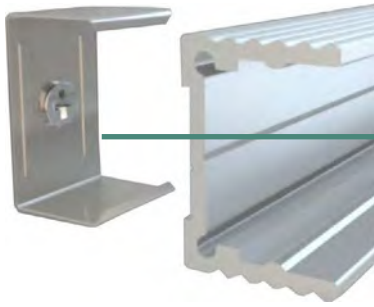

FISSAGGIO A PARETE
con viti
WALL FIXING
with screws

code 14419
Molletta fissa
Fixed clip

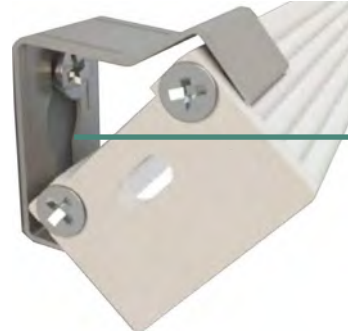

FISSAGGIO A PARETE
con viti
WALL FIXING
with screws

code 14419-IF
Molletta fissa angolare
Fixed angular clip



FISSAGGIO A PARETE
con viti
WALL FIXING
with screws

code 14998
Molletta orientabile
Adjustable clip



DIMENSIONI TAPPI DIMENSION CAPS

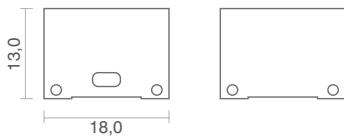

13210- / 13211-
Passacavo/chiuso
per diffusore 14281/14884/14655
Grommet/closed
for diffuser 14281/14884/14655

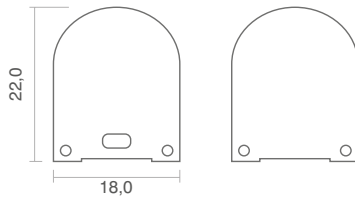

14231- / 14232-
Passacavo/chiuso
per diffusore 14016
Grommet/closed
for diffuser 14016

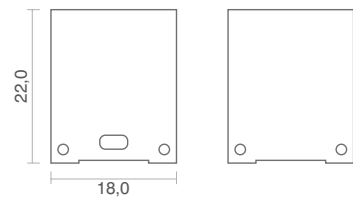

14212- / 14213-
Passacavo/chiuso
per diffusore 14929
Grommet/closed
for diffuser 14929

PROFILO 1912

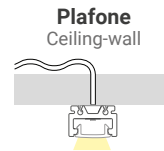

Scheda tecnica
Datasheet



Diffusore
lenticolare
Lenticular diffuser

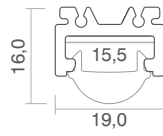
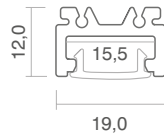

misure in mm / measurements in mm

Alluminio anodizzato
Anodized aluminum

Bianco
White

Nero
Black

LUNGHEZZA MASSIMA: 4m
MAXIMUM LENGTH: 4m

CE IP20

COMPOSIZIONE CODICE KIT
KIT CODE COMPOSITION

Profilo+Diffusore+Tappi (1 chiuso e 1 aperto)+2 Mollette/mt
Profile+Diffuser+Caps (1 closed and 1 open)+2 Clips/mt

COD.BASE
BASE CODE:

1912-

DIFFUSORE
DIFFUSER

O (opale/opal)
T (trasparente/transparent)
S (satinato/satin)
L (lenticolare/lenticular)

FINITURA
FINISH

00 (alluminio/aluminium)
01 (bianco/white)
02 (nero/black)

LUNGHEZZA
LENGTH

L10 (1000mm)
L20 (2000mm)
L30 (3000mm)
L40 (4000mm)



Configuratore di riferimento:
Reference configurator:

Es: 1912-T01L30

CODICI COMPONENTI SINGOLI:
SINGLE COMPONENTS CODES:

PROFILO
PROFILE

COD. BASE
BASE CODE

14008-

FINITURE
FINISH

01

02

L10
L20
L30
L40

DIFFUSORE
DIFFUSER

COD. BASE
BASE CODE

14000-
Trasparente
Transparent
14001-
Opale
Opal
14445-
Satinata
Satin
14002-
Lenticolare
Lenticular

L=

L10
L20
L30
L40

TAPPI
CAPS

COD. BASE
BASE CODE

14004- / 14005-
Passacavo/chiuso
Grommet/closed

14006- / 14007-
Passacavo/chiuso lenticolari - per copertura 14002
Grommet/closed lenticular- for cover 14002

FINITURE
FINISH

01

02

FISSAGGIO
FIXING

COD. BASE
BASE CODE

14185
Molletta
Clip

Senza il codice della finitura il
profilo si intende in alluminio
Without the finish code the
profile is made of aluminium

Senza il codice della finitura i
tappi si intendono in alluminio
Without the finish code i
caps are made of aluminium

OPZIONALE
OPTIONAL

14783
Kit Calamita
Magnet KIT

10807
Kit cassaforma L=2000mm+kit calamita
Formwork kit L=2000mm+magnet kit

*03102
PIR SMD 12~24V

*14071
TOUCH SMD 12~24V

*Escluse con diffusore lenticolare
*Excluded with lenticular diffuser



SERVIZIO DI TAGLIO SU MISURA:

Per informazioni più dettagliate
sul servizio di taglio vedi pag. 230
CUSTOM CUT SERVICE:

For more detailed information
on the cutting service see page 230

PROFILO 2421

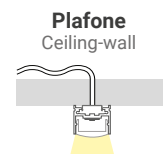

Scheda tecnica
Datasheet

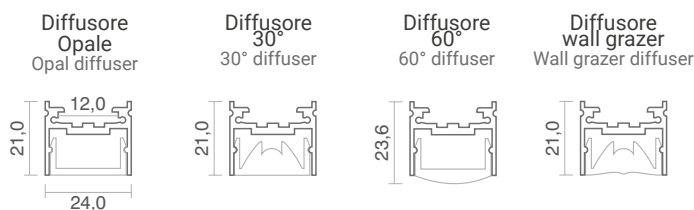
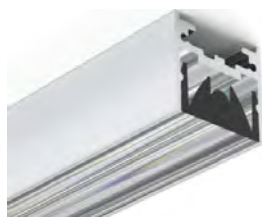

misure in mm / measurements in mm

Alluminio anodizzato
Anodized aluminum

Bianco
White

Nero
Black

LUNGHEZZA MASSIMA: 2m
MAXIMUM LENGTH: 2m

CE IP20



Configuratore di riferimento:
Reference configurator:

Es: 2421-601L20

COMPOSIZIONE CODICE KIT KIT CODE COMPOSITION

Profilo+Diffusore+Tappi (1 chiuso e 1 aperto)+2 Mollette/mt
Profile+Diffuser+Caps (1 closed and 1 open)+2 Clips/mt

COD.BASE
BASE CODE:

2421-

DIFFUSORE
DIFFUSER

0 (opale/opal)
3 (30°)
6 (60°)
WG (Wall grazer)

FINITURA
FINISH

00 (alluminio/aluminium)
01 (bianco/white)
02 (nero/black)

LUNGHEZZA
LENGTH

L10 (1000mm)
L20 (2000mm)

Possibilità inserimento StripLED IP65 solo con diffusori: OPALE e 60°.

Possibility of inserting StripLED IP65 only with diffusers: OPALE and 60°.

CODICI COMPONENTI SINGOLI: SINGLE COMPONENTS CODES:

PROFILO
PROFILE

COD. BASE
BASE CODE

14795-

FINITURA
FINISH

01
02

L=

L10
L20

DIFFUSORE
DIFFUSER

COD. BASE
BASE CODE

14796-
Opale
Opal

14797-
30°

14798-
60°

14799-
Wall grazer

L=

L10
L20

TAPPI
CAPS

COD. BASE
BASE CODE

14801- / 14802-
Passacavo/chiuso
Grommet/closed

FINITURA
FINISH

01
02

FISSAGGIO
FIXING

COD. BASE
BASE CODE

14800
Molletta
Clip

Senza il codice della finitura il profilo si intende in alluminio
Without the finish code the profile is made of aluminium

Senza il codice della finitura i tappi si intendono in alluminio
Without the finish code i caps are made of aluminium

OPZIONALE OPTIONAL



SERVIZIO DI TAGLIO SU MISURA:

Per informazioni più dettagliate sul servizio di taglio vedi pag. 230

CUSTOM CUT SERVICE:

For more detailed information on the cutting service see page 230

PROFILO 3031

Appliche Applique
Sospensione Suspension



Scheda tecnica
Datasheet



Diffusore/ Diffuser
O / T / P
(1)

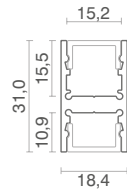

Diffusore/ Diffuser
OA
(2)

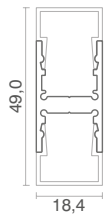

Diffusore/ Diffuser
OT
(3)

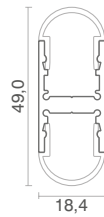

Installazione anche a Sospensione
Installation also in Suspension

Possibilità biemissione
Biemission option

Possibilità doppia stripLED
Double stripLED option

misure in mm / measurements in mm

Aluminio anodizzato Anodized aluminum
Bianco White
Nero Black

LUNGHEZZA MASSIMA: 4m
MAXIMUM LENGTH: 4m

CE IP20

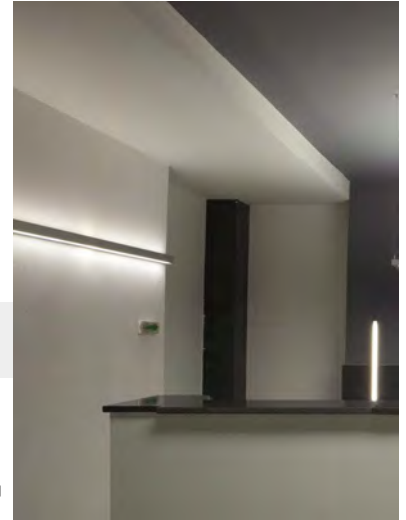

COMPOSIZIONE CODICE KIT KIT CODE COMPOSITION

COD. BASE BASE CODE: EMISSION EMISSION

3031- ME (Monoemis./single emission)
BE (Biemis./biemission)

DIFFUSORE DIFFUSER

O (opale/opal)
T (trasparente/transparent)
OT (opale tondo/round opal)
OA (opale alto/high opal)
P (prismatizzato UGR19/prismatic)

FINITURA FINISH

00 (alluminio/aluminium)
01 (bianco/white)
02 (nero/black)

LUNGHEZZA LENGTH

L10 (1000mm)
L20 (2000mm)
L30 (3000mm)
L40 (4000mm)

ME= Profilo+ Diffusore+Profilo copertura+Staffe e Clip
ME= Profile+Diffuser+Cover profile+Brackets and Clips

BE= Profilo+2 Diffusori+Staffe e Clip
BE= Profile+2 Diffusers+Brackets and Clips

Configuratore di riferimento:
Reference configurator:

Es:3031-BE000L20

Nella versione MONOEMISSIONE sarà sempre applicato il profilo di alluminio 14285 come copertura superiore.

In the SINGLE EMISSION version, the 14285 aluminum profile will always be applied as the upper cover.

Massimo wattaggio per biemissione 16W/m.

Maximum wattage for biemission 16W/m.

CODICI COMPONENTI SINGOLI: SINGLE COMPONENTS CODES:

PROFILO PROFILE

COD. BASE BASE CODE: FINITURA FINISH L=

14280- 01 L10
02 L20
L30
L40

14285-
Profilo copertura
14,8xh7,8mm per
MONOEMISSIONE
Cover profile
14,8xh7,8mm for
SINGLE EMISSION

Senza il codice della finitura il profilo si intende in alluminio
Without the finish code the profile is made of aluminium

DIFFUSORE DIFFUSER L=

COD. BASE BASE CODE

14284- Trasparente (1) L10
Trasparent L20
L30
L40
14281- Opale (1)
Opal
14655- Prismatizzato (1)
Prismatic
14929- Opale alto (2)
High opal
14016- Opale tondo (3)
Round opal

14282
Staffa L=100mm foro ø6mm
per fissaggio a PLAFONE.
Bracket L=100mm hole ø6mm
for CEILING fixing.

TAPPI CAPS

COD. BASE BASE CODE

14214P- / 14214C Passacavo/chiuso (1)
Grommet/closed
25009P- / 25009C- Passacavo/chiuso per DOPPIO diffusore 14929 (2)
Grommet/closed for DOUBLE diffuser 14929
25007P- / 25007C- Passacavo/chiuso per DOPPIO diffusore 14016 (3)
Grommet/closed for DOUBLE diffuser 14016

Senza il codice della finitura i tappi si intendono in alluminio
Without the finish code i caps are made of aluminium

FINITURA FINISH

COD. BASE BASE CODE

01
02

FISSAGGIO FIXING

COD. BASE BASE CODE

14962- Kit 2 staffe simmetriche ox. argento per fissaggio APPLIQUE.
Kit for 2 symmetrical ox. silver brackets for fixing APPLIQUE.

14210
Clip in ottone per staffe 14962
Brass clip for brackets 14962

FINITURA FINISH

COD. BASE BASE CODE

00
01
02

OPZIONALE OPTIONAL

15139
Kit sospensione 2 cavi L=2500mm
Suspension kit 2 cables L=2500mm

SERVIZIO DI TAGLIO SU MISURA:
Per informazioni più dettagliate sul servizio di taglio vedi pag. 230
CUSTOM CUT SERVICE:
For more detailed information on the cutting service see page 230

PROFILO 3031 - APPROFONDIMENTO/Insight

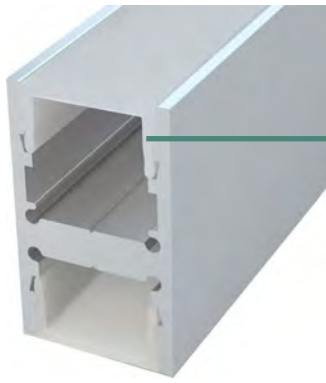

MONOEMISSIONE
Alimentatore esterno
SINGLE EMISSION
External power supply

code 14285
Profilo copertura
Cover profile



BIEMISSIONE
Alimentatore esterno
BIEMISSION
External power supply



APPLIQUE
Fissaggio a parete tramite
staffe simmetriche
APPLIQUE
Wall fixing via symmetrical
brackets

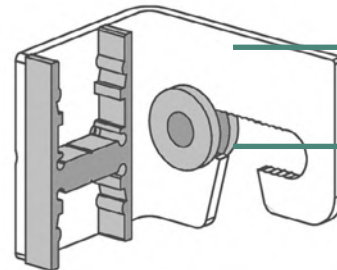

code 14962
Staffa simmetrica
Symmetrical bracket

code 14210
Clip in ottone
Brass clip



PLAFONE
Fissaggio a soffitto tramite staffe
CEILING
Fix the bracket to the wall

code 14282
Staffa L=100mm foro \varnothing 6mm
Bracket L=100mm hole \varnothing 6mm



SOSPENSIONE
Kit sospensione L=2500mm
SUSPENSION
Suspension kit L=2500mm

code 15139
composto da:
Rosoncino autobloccante
Attacco D8x16,5mm
Cavo in acciaio L=2500mm
Staffa 50mm foro \varnothing 1,4mm
Prigioniero filettato maschio
composed of:
Ceiling attachment with griplock
D8x16,5mm socket
Steel cable L=2500mm
50mm bracket
Male threaded stud

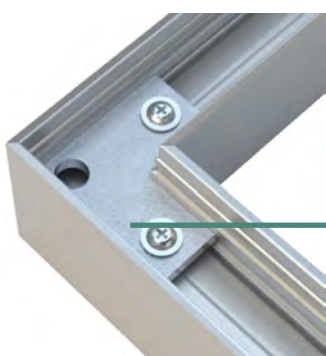

GIUNZIONE ANGOLARE
(Predisposta per la sospensione)
CORNER JOINT
(Prepared for suspension)

code 14211
Giunzione angolare
Corner joint

PROFILO 4817

Applique
Applique



Scheda tecnica
Datasheet

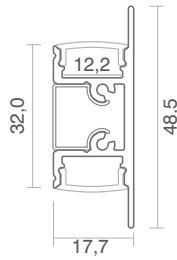

Biemissione
Biemission

Installazione anche a Sospensione
Installation also in Suspension

Possibilità doppia stripLED
Double stripLED option

misure in mm / measurements in mm



Alluminio anodizzato
Anodized aluminum

Bianco
White

Nero
Black

LUNGHEZZA MASSIMA: 2m
MAXIMUM LENGTH: 2m

CE IP20

COMPOSIZIONE CODICE KIT

KIT CODE COMPOSITION

Profilo+2 Diffusori+Tappi (1 chiuso e 1 aperto)+Staffa
Profile+2 Diffusers+Caps (1 closed and 1 open)+Bracket

COD.BASE **EMISSIONE** 
BASE CODE: EMISSION

4817- **BE** (Biemis./biemission)

DIFFUSORE 
DIFFUSER

O (opale/opal)
T (trasparente/transparent)

FINITURA 
FINISH

00 (alluminio/aluminium)
01 (bianco/white)
02 (nero/black)

LUNGHEZZA 
LENGTH

L10 (1000mm)
L20 (2000mm)

Configuratore di riferimento:
Reference configurator:
Es: 4817-BE000L20

CODICI COMPONENTI SINGOLI:

SINGLE COMPONENTS CODES:

PROFILO
PROFILE

COD. BASE 
BASE CODE

14648-

FINITURE 
FINISH

L=

01
02

L10
L20

DIFFUSORE
DIFFUSER

COD. BASE 
BASE CODE

L=

14651-
Opale
Opal

14610-
Trasparente
Transparent

L10
L20

TAPPI
CAPS

COD. BASE
BASE CODE

14649- / 14650-
Passacavo/chiuso
Grommet/closed

FINITURE 
FINISH

01
02

FISSAGGIO
FIXING

COD. BASE 
BASE CODE

14652
Staffa
Bracket

Senza il codice della finitura il profilo si intende in alluminio
Without the finish code the profile is made of aluminium

Senza il codice della finitura i tappi si intendono in alluminio
Without the finish code i caps are made of aluminium

OPZIONALE

OPTIONAL



SERVIZIO DI TAGLIO SU MISURA:

Per informazioni più dettagliate sul servizio di taglio vedi pag. 230
CUSTOM CUT SERVICE:

For more detailed information on the cutting service see page 230



Profilo 3031 biemissione con installazione a sospensione
Profile 3031 biemissione with suspension installation

PROFILO 4731

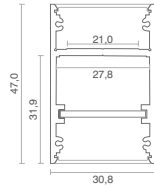

Diffusore opale alto
High opal diffuser

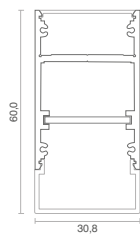

Installazione anche a Sospensione
Installation also in Suspension

Possibilità alim. interno (solo monoemissione)
internal power supply option (single emission only)

Possibilità doppia stripLED
Double stripLED option

misure in mm / measurements in mm

Applique/Plafone/Sosp.
Applique/Ceiling-wall/Suspension

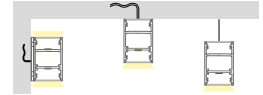

Scheda tecnica
Datasheet

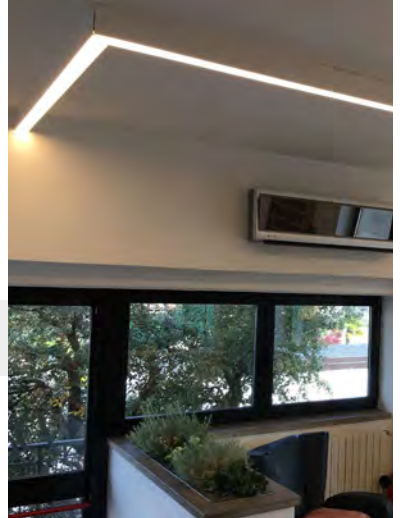

Alluminio anodizzato
Anodized aluminum

Bianco
White

Nero
Black

LUNGHEZZA MASSIMA: 4m
MAXIMUM LENGTH: 4m

CE IP20

COMPOSIZIONE CODICE KIT KIT CODE COMPOSITION

COD.BASE
BASE CODE:

EMISSIONE
EMISSION



4731- **ME** (Monoemis./single emission)
BE (Biemis./biemission)

DIFFUSORE
DIFFUSER



O (opale/opal)
OA (opale alto/high opal)
P (prism.UGR19/prismatic)

FINITURA
FINISH



00 (alluminio/aluminium)
01 (bianco/white)
02 (nero/black)

LUNGHEZZA
LENGTH



L10 (1000mm)
L20 (2000mm)
L30 (3000mm)
L40 (4000mm)

ME= Profilo+Diffusore+Profilo copertura+Staffe e clip
ME= Profile+Diffuser+Cover profile+Brackets and clips

BE= Profilo+2 Diffusori+Dissipatore interno+Staffe e clip
BE= Profile+2 Diffusers+Internal heatsink+Brackets and clips

Configuratore di riferimento:
Reference configurator:

Es: 4731-BE000L40

Nella versione MONOEMISSIONE sarà sempre applicato il profilo di alluminio 13006 come copertura superiore.

In the SINGLE EMISSION version, the 13006 aluminum profile will always be applied as the upper cover.

CODICI COMPONENTI SINGOLI: SINGLE COMPONENTS CODES:

PROFILO
PROFILE



COD. BASE
BASE CODE

FINITURA
FINISH

L=

14794-

01
02

L10
L20
L30
L40

13006-
Profilo copertura
28x3,1mm per
monoemissione
Cover profile
28x3,1mm for
single emission

Senza il codice della finitura il
profilo si intende in alluminio
Without the finish code the
profile is made of aluminium

DIFFUSORE
DIFFUSER



COD. BASE
BASE CODE

L=

14018-
Opale
Opal

25010-
Opale alta
High opal

L10
L20
L30
L40

25011-
Prismatizzato
Prismatic

TAPPI
CAPS



COD. BASE
BASE CODE

FINITURA
FINISH

14834- / 14959-
Passacavo/chiuso
Grommet/closed

01
02

25012P- / 25012C-
Passacavo/chiuso per diffusori:
14018+25010 / 25011+25010
Grommet/closed for diffuser:
14018+25010 / 25011+25010

25013P- / 25013C-
Passacavo/chiuso per DOPPIO
diffusore **25010**
Grommet/closed for DOUBLE
diffuser **25010**

Senza il codice della finitura i
tappi si intendono in alluminio
Without the finish code i
caps are made of aluminium

DISSIPATORE
DISSIPATOR



COD. BASE
BASE CODE

L=

14456-
Dissipatore interno
25x2mm
Internal dissipator
25x2mm

L10
L20
L30
L40

FISSAGGIO
FIXING



COD. BASE
BASE CODE

FINITURA
FINISH

13001-
Kit 2 staffe simmetriche
ox.argento per fissaggio
applique.
Kit for 2 symmetrical
ox.silver brackets
for fixing applique.

00
01
02

14210
Clip in ottone per staffe 13001
Brass clip for brackets 13001

OPZIONALE OPTIONAL

15158
Kit sospensione 2 cavi L=2500mm
Suspension kit 2 cables L=2500mm

13002
Clip in ottone fiss.a plafone
Brass clip for ceiling fix



SERVIZIO DI TAGLIO SU MISURA:

Per informazioni più dettagliate
sul servizio di taglio vedi pag. 230
CUSTOM CUT SERVICE:

For more detailed information
on the cutting service see page 230

PROFILO 4731 - APPROFONDIMENTO/Insight

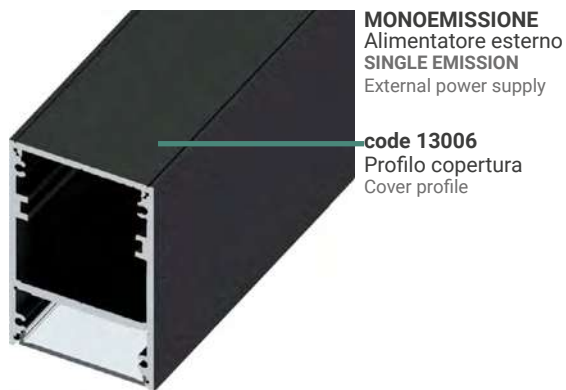

MONOEMISSIONE
Alimentatore esterno
SINGLE EMISSION
External power supply

code 13006
Profilo copertura
Cover profile

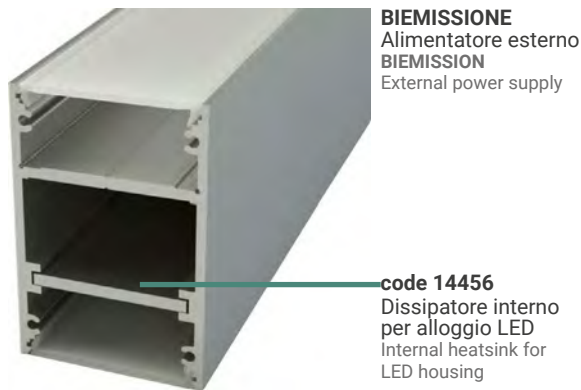

BIEMISSIONE
Alimentatore esterno
BIEMISSION
External power supply

code 14456
Dissipatore interno
per alloggiamento LED
Internal heatsink for
LED housing

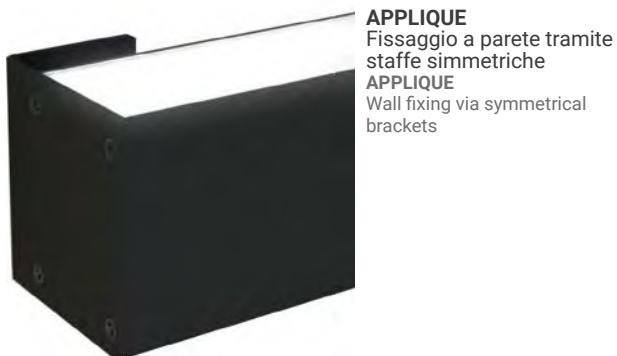

APPLIQUE
Fissaggio a parete tramite
staffe simmetriche
APPLIQUE
Wall fixing via symmetrical
brackets

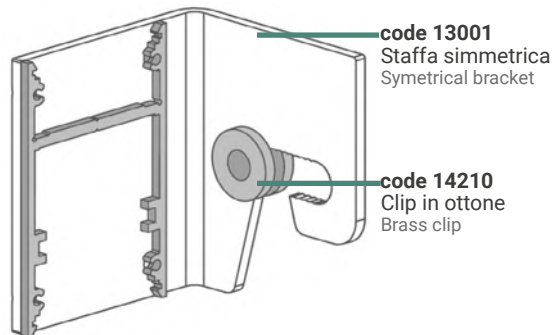

code 13001
Staffa simmetrica
Symmetrical bracket

code 14210
Clip in ottone
Brass clip

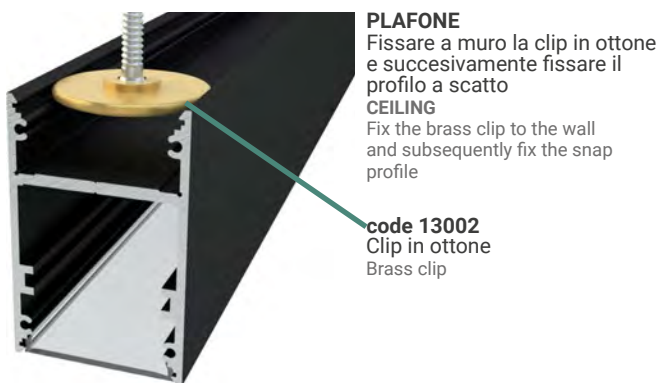

PLAFONE
Fissare a muro la clip in ottone
e successivamente fissare il
profilo a scatto
CEILING
Fix the brass clip to the wall
and subsequently fix the snap
profile

code 13002
Clip in ottone
Brass clip

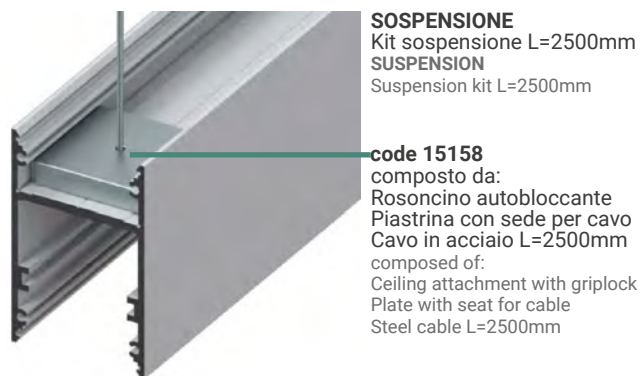

SOSPENSIONE
Kit sospensione L=2500mm
SUSPENSION
Suspension kit L=2500mm

code 15158
composto da:
Rosoncino autobloccante
Piastrina con sede per cavo
Cavo in acciaio L=2500mm
composed of:
Ceiling attachment with griplock
Plate with seat for cable
Steel cable L=2500mm



Codice tappo: 25012P-00
Adatto per:
diffusore opale 14018 +
diffusore opale alto 25010
Cap code: 25012C
Suitable for:
opal diffuser 14018 + high opal
diffuser 25010



Codice tappo: 25013P-00
Adatto per:
doppio diffusore opale alto
25010
Cap code: 25013P-00
Suitable for:
double high opal diffuser 25010

PROFILO 3546

Plafone Ceiling-wall Sospensione Suspension

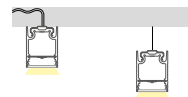

Scheda tecnica Datasheet

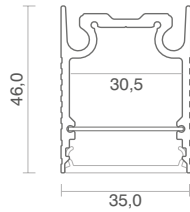

Installazione anche a Sospensione
Installation also in Suspension

Possibilità doppia stripLED
Double stripLED option

Possibilità alim. interno
internal power supply option

misure in mm / measurements in mm

Alluminio anodizzato Anodized aluminum Bianco White Nero Black

LUNGHEZZA MASSIMA: 4m
MAXIMUM LENGTH: 4m

CE IP20

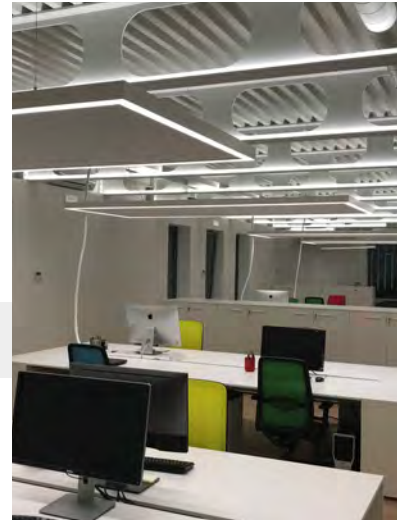

Configuratore di riferimento:
Reference configurator:

Es: 3546-T00L20

COMPOSIZIONE CODICE KIT KIT CODE COMPOSITION

Profilo+Diffusore+Tappi (1 chiuso e 1 aperto)+dissipatore+2 Mollette/
Profile+Diffuser+Caps (1 closed and 1 open)+dissipator+2 Clips/mt

COD.BASE
BASE CODE:

3546-

DIFFUSORE
DIFFUSER

O (opale/opal)
T (trasparente/transparent)
P (prismatizzato UGR19/prismatic)

FINITURA
FINISH

00 (alluminio/aluminium)
01 (bianco/white)
02 (nero/black)

LUNGHEZZA
LENGTH

L10 (1000mm)
L20 (2000mm)
L30 (3000mm)
L40 (4000mm)

CODICI COMPONENTI SINGOLI: SINGLE COMPONENTS CODES:

PROFILO
PROFILE
COD. BASE
BASE CODE
14301-

FINITURE
FINISH
L=
01
02
L10
L20
L30
L40

DIFFUSORE
DIFFUSER
COD. BASE
BASE CODE
14370-
Trasparente
Transparent
14371-
Opale
Opal
14495-
Prismatizzato
Prismatic
L=
L10
L20
L30
L40

TAPPI
CAPS
COD. BASE
BASE CODE
14442- / 14300-
Passacavo/chiuso
Grommet/closed
FINITURE
FINISH
L=
01
02

DISSIPATORE
DISSIPATOR
COD. BASE
BASE CODE
14461-
Dissipatore interno
31x1mm
Internal dissipator
31x1mm
L=
L10
L20
L30
L40

FISSAGGIO
FIXING
COD. BASE
BASE CODE
14043
Molletta
Clip

Senza il codice della finitura il profilo si intende in alluminio
Without the finish code the profile is made of aluminium

Senza il codice della finitura i tappi si intendono in alluminio
Without the finish code i caps are made of aluminium

OPZIONALE OPTIONAL

15141
Kit sospensione 2 cavi L=2500mm
Suspension kit 2 cables L=2500mm

07474
DRIVER 24VDC 30W CLASSE II IP20 SLIM
07604
DRIVER 24VDC 60W CLASSE II IP20 SLIM

ATTACCO A BINARIO
VEDERE PAGINA 294
RAIL ATTACHMENT
SEE PAGE 294



SERVIZIO DI TAGLIO SU MISURA:

Per informazioni più dettagliate sul servizio di taglio vedi pag. 230
CUSTOM CUT SERVICE:

For more detailed information on the cutting service see page 230

PROFILO 5690

Plafone Ceiling-wall Sospensione Suspension



Scheda tecnica Datasheet

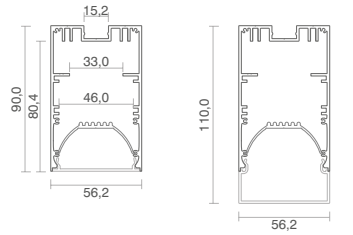

Diffusore Opale alto
Diffuser High opal

Installazione anche a Sospensione
Installation also in Suspension

Possibilità doppia stripLED
Double stripLED option

Possibilità alim.
+centralina (cod.09369) interni
Possibility of internal power supply
+ (code 09369) internal control unit

mmure in mm / measurements in mm

■ Alluminio anodizzato Anodized aluminum □ Bianco White ■ Nero Black

LUNGHEZZA MASSIMA: 4m
MAXIMUM LENGTH: 4m

CE IP20

COMPOSIZIONE CODICE KIT
KIT CODE COMPOSITION

Profile+Diffusore+Tappi (1 chiuso e 1 aperto)+parabola+2 Mollette/
Profile+Diffuser+Caps (1 closed and 1 open)+parabole+2 Clips/mt

COD.BASE BASE CODE: DIFFUSORE DIFFUSER

5690-
O (opale/opal)
OA (opale alto/high opal)
T (trasparente/transparent)
P (prismatizzato UGR19/prismatic)

FINITURA FINISH

00 (alluminio/aluminium)
01 (bianco/white)
02 (nero/black)

LUNGHEZZA LENGTH

L10 (1000mm)
L20 (2000mm)
L30 (3000mm)
L40 (4000mm)



Configuratore di riferimento:
Reference configurator:

Es: 5690-T00L20

CODICI COMPONENTI SINGOLI:
SINGLE COMPONENTS CODES:

PROFILO PROFILE
COD. BASE BASE CODE FINITURE FINISH L=
14409-
01
02
L10
L20
L30
L40

DIFFUSORE DIFFUSER
COD. BASE BASE CODE L=
14019- Trasparente Transparent
14037- Opale Opal
13010- Opale alto High opal
14490- Prismatizzato Prismatic

TAPPI CAPS
COD. BASE BASE CODE FINITURE FINISH
14412- / 14413- Passacavo/chiuso Grommet/closed
25014P- / 25014C- Passacavo/chiuso alto per diffusore 13010 Grommet/closed high for diffuser 13010
01
02

PARABOLA PARABLE
COD. BASE BASE CODE L=
14789- Parabola porta LED Parable contains LED
L10
L20
L30
L40

FISSAGGIO FIXING
COD. BASE BASE CODE
14282 Staffa L=100mm foro ø6mm per fissaggio a plafone. Bracket L=100mm hole ø6mm for ceiling fixing.

Senza il codice della finitura il profilo si intende in alluminio
Without the finish code the profile is made of aluminium

Senza il codice della finitura i tappi si intendono in alluminio
Without the finish code i caps are made of aluminium

OPZIONALE OPTIONAL

15139
Kit sospensione 2 cavi L=2500mm
Suspension kit 2 cables L=2500mm

14037-20M
Diffusore opale lucido L=20m
Glossy opal diffuser L=20m

07474
DRIVER 24VDC 30W CLASSE II IP20 SLIM
07604
DRIVER 24VDC 60W CLASSE II IP20 SLIM
07617
DRIVER 24VDC 100W CLASSE II IP20 SLIM

5690-P4
Giunto lineare in alluminio
Aluminum linear joint
5690-P1
Giunto angolare in alluminio
Aluminum angular joint



SERVIZIO DI TAGLIO SU MISURA:

Per informazioni più dettagliate sul servizio di taglio vedi pag. 230
CUSTOM CUT SERVICE:

For more detailed information on the cutting service see page 230

PROFILO 1828 - Luce recessa

Deeply recessed

Plafone Ceiling-wall
Sospensione Suspension

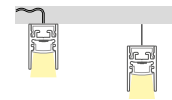

Scheda tecnica
Datasheet

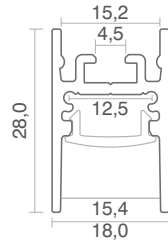

Installazione anche
a Sospensione
Installation also
in Suspension

UGR<19

misure in mm / measurements in mm

Alluminio anodizzato
Anodized aluminum

Bianco
White

Nero
Black

LUNGHEZZA MASSIMA: 4m
MAXIMUM LENGTH: 4m

CE IP20

COMPOSIZIONE CODICE KIT
KIT CODE COMPOSITION

Profilo+Diffusore+Tappi (1 chiuso e 1 aperto)+Staffa
Profile+Diffuser+Caps (1 closed and 1 open)+Bracket

COD.BASE
BASE CODE:

1828-

DIFFUSORE
DIFFUSER

O (opale/opal)
T (trasparente/transparent)
S (satinato/satin)

FINITURA
FINISH

00 (alluminio/aluminium)
01 (bianco/white)
02 (nero/black)

LUNGHEZZA
LENGTH

L10 (1000mm)
L20 (2000mm)
L30 (3000mm)
L40 (4000mm)



Configuratore di riferimento:
Reference configurator:

Es: 1828-S02L30

CODICI COMPONENTI SINGOLI:
SINGLE COMPONENTS CODES:

PROFILO
PROFILE

COD. BASE
BASE CODE

14567-

FINITURE
FINISH

L=

01
02

L10
L20
L30
L40

DIFFUSORE
DIFFUSER

COD. BASE
BASE CODE

14000-
Trasparente
Transparent

14001-
Opale
Opal

14445-
Satinata
Satin

L=

L10
L20
L30
L40

TAPPI
CAPS

COD. BASE
BASE CODE

14565- / 14566-
Passacavo/chiuso
Grommet/closed

FINITURE
FINISH

01
02

FISSAGGIO
FIXING

COD. BASE
BASE CODE

14285-STAF
Staffa L=50mm
foro ø1,4mm
per fissaggio a
sospensione.
Bracket L=50mm
hole ø1,4mm
for suspension fixing.

Senza il codice della finitura il
profilo si intende in alluminio
Without the finish code the
profile is made of aluminium

Senza il codice della finitura i
tappi si intendono in alluminio
Without the finish code i
caps are made of aluminium

OPZIONALE
OPTIONAL

15139
Kit sospensione 2 cavi L=2500mm
Suspension kit 2 cables L=2500mm



SERVIZIO DI TAGLIO SU MISURA:

Per informazioni più dettagliate
sul servizio di taglio vedi pag. 230
CUSTOM CUT SERVICE:

For more detailed information
on the cutting service see page 230

PROFILO 2743 - Luce recessa

Deeply recessed

Plafone Ceiling-wall Sospensione Suspension

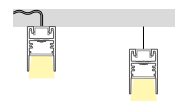

Scheda tecnica
Datasheet

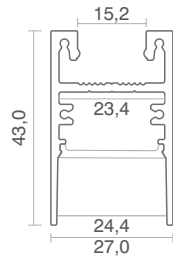

Installazione anche a Sospensione
Installation also in Suspension

UGR<19

misure in mm / measurements in mm

Alluminio anodizzato Anodized aluminum Bianco White Nero Black

LUNGHEZZA MASSIMA: 4m
MAXIMUM LENGTH: 4m

CE IP20



COMPOSIZIONE CODICE KIT

KIT CODE COMPOSITION

Profilo+Diffusore+Tappi (1 chiuso e 1 aperto)+Staffa
Profile+Diffuser+Caps (1 closed and 1 open)+Bracket

COD.BASE **DIFFUSORE**
BASE CODE: DIFFUSER
2743- **0** (opale/opal)

FINITURA
FINISH
00 (alluminio/aluminium)
01 (bianco/white)
02 (nero/black)

LUNGHEZZA
LENGTH
L10 (1000mm)
L20 (2000mm)
L30 (3000mm)
L40 (4000mm)

CODICI COMPONENTI SINGOLI:

SINGLE COMPONENTS CODES:

PROFILO
PROFILE
COD. BASE **FINITURA** **L=**
BASE CODE FINISH
14570- **01** **L10**
 02 **L20**
 L30
 L40

DIFFUSORE
DIFFUSER
COD. BASE **L=**
BASE CODE
14286- **L10**
Opale **L20**
Opal **L30**
 L40

TAPPI
CAPS
COD. BASE
BASE CODE
14568- / 14569-
Passacavo/chiuso
Grommet/closed

FISSAGGIO
FIXING
COD. BASE
BASE CODE
14285-STAF
Staffa L=50mm
foro ø1,4mm
per fissaggio a
sospensione.
Bracket L=50mm
hole ø1,4mm
for suspension fixing.

Senza il codice della finitura il profilo si intende in alluminio
Without the finish code the profile is made of aluminium

Senza il codice della finitura i tappi si intendono in alluminio
Without the finish code i caps are made of aluminium

OPZIONALE

OPTIONAL

15139
Kit sospensione 2 cavi L=2500mm
Suspension kit 2 cables L=2500mm



SERVIZIO DI TAGLIO SU MISURA:

Per informazioni più dettagliate sul servizio di taglio vedi pag. 230

CUSTOM CUT SERVICE:

For more detailed information on the cutting service see page 230

PROFILO 2027 - Tutta luce All light

Plafone Ceiling-wall
Sospensione Suspension



Scheda tecnica
Datasheet

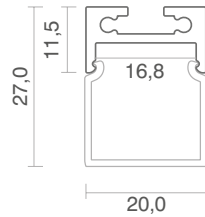

misure in mm / measurements in mm

Installazione anche
a Sospensione.
Luce a 180°
Installation also
in Suspension
Light at 180°

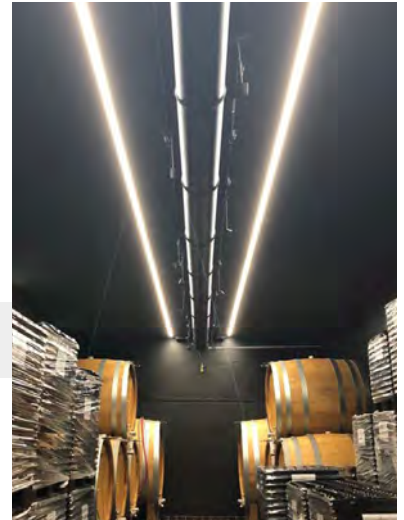

Alluminio anodizzato
Anodized aluminum

Bianco
White

Nero
Black

LUNGHEZZA MASSIMA: 2m
MAXIMUM LENGTH: 2m

CE IP20

COMPOSIZIONE CODICE KIT KIT CODE COMPOSITION

Profilo+Diffusore+Tappi (1 chiuso e 1 aperto)+2 Mollette/mt
Profile+Diffuser+Caps (1 closed and 1 open)+2 Clips/mt

COD. BASE
BASE CODE:
2027-

DIFFUSORE
DIFFUSER 
0 (opale/opal)

FINITURA
FINISH 
00 (alluminio/aluminium)
01 (bianco/white)
02 (nero/black)

LUNGHEZZA
LENGTH 
L10 (1000mm)
L20 (2000mm)

Configuratore di riferimento:
Reference configurator:
Es: 2027-000L20

CODICI COMPONENTI SINGOLI: SINGLE COMPONENTS CODES:

PROFILO
PROFILE 
COD. BASE
BASE CODE
14589-

FINITURE
FINISH 
01
02

L=
L10
L20

DIFFUSORE
DIFFUSER 
COD. BASE
BASE CODE
14592-
Opale
Opal

L=
L10
L20

TAPPI
CAPS 
COD. BASE
BASE CODE
14590- / 14591-
Passacavo/chiuso
Grommet/closed

FINITURE
FINISH 
01
02

FISSAGGIO
FIXING 
COD. BASE
BASE CODE
14138
Molletta
Clip

Senza il codice della finitura il
profilo si intende in alluminio
Without the finish code the
profile is made of aluminium

Senza il codice della finitura i
tappi si intendono in alluminio
Without the finish code i
caps are made of aluminium

OPZIONALE OPTIONAL

15140
Kit sospensione 2 cavi L=2500mm
Suspension kit 2 cables L=2500mm



SERVIZIO DI TAGLIO SU MISURA:

Per informazioni più dettagliate
sul servizio di taglio vedi pag. 230

CUSTOM CUT SERVICE:

For more detailed information
on the cutting service see page 230

PROFILO 7336 - Tutta luce All light

Plafone Ceiling-wall
Sospensione Suspension

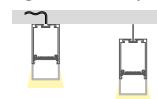

Scheda tecnica
Datasheet

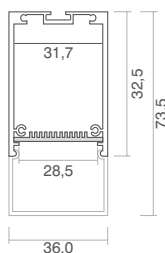

Installazione anche a Sospensione
Installation also in Suspension

Possibilità doppia stripLED
Double stripLED option

Possibilità alim. SLIM
Possibility of SLIM power supply

misure in mm / measurements in mm

Alluminio anodizzato Anodized aluminum
 Bianco White
 Nero Black

LUNGHEZZA MASSIMA: 2m
MAXIMUM LENGTH: 2m

CE IP20



Configuratore di riferimento:
Reference configurator:

Es: 7336-000L20

COMPOSIZIONE CODICE KIT
KIT CODE COMPOSITION

Profilo+Diffusore+Piastra+Tappi (1 chiuso e 1 aperto)
Profile+Diffuser+Plate+Caps (1 closed and 1 open)

COD.BASE BASE CODE:
7336-

DIFFUSORE DIFFUSER
0 (opale/opal)

FINITURA FINISH
00 (alluminio/aluminium)
01 (bianco/white)
02 (nero/black)

LUNGHEZZA LENGTH
L10 (1000mm)
L20 (2000mm)

CODICI COMPONENTI SINGOLI:
SINGLE COMPONENTS CODES:

PROFILO PROFILE
COD. BASE BASE CODE
14594-

FINITURE FINISH
L=
01
02

L10
L20

DIFFUSORE DIFFUSER
COD. BASE BASE CODE
14597-

Opale
Opal

L=
L10
L20

TAPPI CAPS
COD. BASE BASE CODE
14595- / 14596-

Passacavo/chiuso
Grommet/closed

FINITURE FINISH
01
02

PIASTRA PLATE
COD. BASE BASE CODE
14474

Piastra porta LED
LED holder plate

L=
L10
L20

Senza il codice della finitura il profilo si intende in alluminio
Without the finish code the profile is made of aluminium

Senza il codice della finitura i tappi si intendono in alluminio
Without the finish code i caps are made of aluminium

OPZIONALE
OPTIONAL

15080
Kit sospensione 2 cavi L=2500mm
Suspension kit 2 cables L=2500mm

07474
DRIVER 24VDC 30W CLASSE II IP20 SLIM
07604
DRIVER 24VDC 60W CLASSE II IP20 SLIM

07617
DRIVER 24VDC 100W CLASSE II IP20 SLIM



SERVIZIO DI TAGLIO SU MISURA:

Per informazioni più dettagliate sul servizio di taglio vedi pag. 230
CUSTOM CUT SERVICE:

For more detailed information on the cutting service see page 230

PROFILO 5634

Plafone Ceiling-wall Sospensione Suspension

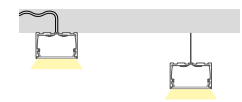

Scheda tecnica Datasheet

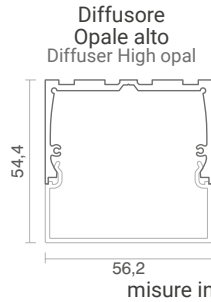
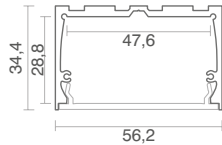

Diffusore Opale alto
Diffuser High opal

Installazione anche a Sospensione
Installation also in Suspension

Possibilità doppia o tripla stripLED
Double or triple stripLED option



Configuratore di riferimento:
Reference configurator:
Es:5634-000L20

Alluminio anodizzato Anodized aluminum Bianco White Nero Black

LUNGHEZZA MASSIMA: 4m
MAXIMUM LENGTH: 4m

CE IP20

COMPOSIZIONE CODICE KIT KIT CODE COMPOSITION

COD.BASE
BASE CODE:
5634-

DIFFUSORE
DIFFUSER

O (opale/opal)
OA (opale alto/high opal)
T (trasparente/transparent)
***P** (prismatizzato UGR19/prismatic)

FINITURA
FINISH

00 (alluminio/aluminium)
01 (bianco/white)
02 (nero/black)

Profilo+Diffusore+Tappi (1 chiuso e 1 aperto)
Profile+Diffuser+Caps (1 closed and 1 open)

LUNGHEZZA
LENGTH

***L10** (1000mm)
***L20** (2000mm)
L30 (3000mm)
L40 (4000mm)

*P: disponibile solo L10/L20 / *P: available only L10/L20

CODICI COMPONENTI SINGOLI: SINGLE COMPONENTS CODES:

PROFILO
PROFILE

COD. BASE
BASE CODE
14369-

FINITURE
FINISH

L=

01
02

L10
L20
L30
L40

DIFFUSORE
DIFFUSER

COD. BASE
BASE CODE
14019-
Trasparente
Transparent

14037-
Opale
Opal

13010-
Opale alto
High opal

***14575-**
Prismatizzata
Prismatic

L=

***L10**
***L20**
L30
L40

TAPPI
CAPS

COD. BASE
BASE CODE
14377- / 14379-
Passacavo/chiuso
Grommet/closed

25015P- / 25015C-
Passacavo/chiuso alto
per diffusore 13010
Grommet/closed high
for diffuser 13010

FINITURE
FINISH

01
02

Senza il codice della finitura il profilo si intende in alluminio
Without the finish code the profile is made of aluminium

Senza il codice della finitura i tappi si intendono in alluminio
Without the finish code i caps are made of aluminium

OPZIONALE OPTIONAL

14037-20M
Diffusore opale lucido L=20m
Glossy opal diffuser L=20m



SERVIZIO DI TAGLIO SU MISURA:

Per informazioni più dettagliate sul servizio di taglio vedi pag. 230
CUSTOM CUT SERVICE:

For more detailed information on the cutting service see page 230

PROFILO 2110

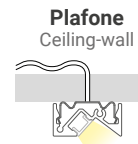

Scheda tecnica
Datasheet

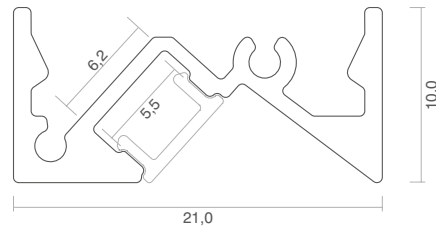

misure in mm / measurements in mm

Compatibile solo con Micro StripLED da 4mm a pag.75
Compatible only with 4mm Micro StripLED on page 75

Alluminio anodizzato
Anodized aluminum

Bianco
White

Nero
Black

LUNGHEZZA MASSIMA: 2m
MAXIMUM LENGTH: 2m

CE IP20

COMPOSIZIONE CODICE KIT KIT CODE COMPOSITION

Profilo+Diffusore+Tappi (1 chiuso e 1 aperto)+2 Mollette/mt
Profile+Diffuser+Caps (1 closed and 1 open)+2 Clips/mt

COD.BASE
BASE CODE:
2110-

DIFFUSORE
DIFFUSER 
0 (opale/opal)

FINITURA
FINISH 
00 (alluminio/aluminium)
01 (bianco/white)
02 (nero/black)

LUNGHEZZA
LENGTH 
L10 (1000mm)
L20 (2000mm)



Configuratore di riferimento:
Reference configurator:
Es: 2110-000L20

CODICI COMPONENTI SINGOLI: SINGLE COMPONENTS CODES:

PROFILO
PROFILE 
COD. BASE
BASE CODE
12002-

FINITURE
FINISH 
L=

01
02

L10
L20

DIFFUSORE
DIFFUSER 
COD. BASE
BASE CODE
12003-
Opale
Opal

L=

L10
L20

TAPPI
CAPS 
COD. BASE
BASE CODE
12004- / 12005-
Passacavo/chiuso
Grommet/closed

FINITURE
FINISH 
01
02

FISSAGGIO
FIXING 
COD. BASE
BASE CODE
12006
Molletta
18,3x6,6x15mm
Clip
18,3x6,6x15mm

Senza il codice della finitura il profilo si intende in alluminio
Without the finish code the profile is made of aluminium

Senza il codice della finitura i tappi si intendono in alluminio
Without the finish code i caps are made of aluminium

OPZIONALE OPTIONAL



SERVIZIO DI TAGLIO SU MISURA:

Per informazioni più dettagliate sul servizio di taglio vedi pag. 230

CUSTOM CUT SERVICE:

For more detailed information on the cutting service see page 230

PROFILO 5015

Plafone
Ceiling-wall



Scheda tecnica
Datasheet

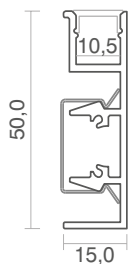

**Adatto come
battitacco luminoso**
Suitable as
luminous baseboard



misure in mm / measurements in mm

Alluminio anodizzato
Anodized aluminum

Bianco
White

Nero
Black

LUNGHEZZA MASSIMA: 2m
MAXIMUM LENGTH: 2m

CE IP20

COMPOSIZIONE CODICE KIT KIT CODE COMPOSITION

Profilo+Diffusore+Tappi chiusi+2 Mollette/mt
Profile+Diffuser+Caps closed+2 Clips/mt

COD.BASE
BASE CODE:

5015-

DIFFUSORE
DIFFUSER

0 (opale/opal)

FINITURA
FINISH

00 (alluminio/aluminium)
01 (bianco/white)
02 (nero/black)

LUNGHEZZA
LENGTH

L10 (1000mm)
L20 (2000mm)

Configuratore di riferimento:
Reference configurator:

Es: 5015-000L20

CODICI COMPONENTI SINGOLI: SINGLE COMPONENTS CODES:

PROFILO
PROFILE

COD. BASE
BASE CODE

14901-

FINITURE
FINISH

01
02

L=

L10
L20

DIFFUSORE
DIFFUSER

COD. BASE
BASE CODE

14633-
Opale
Opal

L=

L10
L20

TAPPI
CAPS

COD. BASE
BASE CODE

14903-
Chiuso
Closed

FINITURE
FINISH

01
02

FISSAGGIO
FIXING

COD. BASE
BASE CODE

14904
Molletta
Clip

Senza il codice della finitura il
profilo si intende in alluminio
Without the finish code the
profile is made of aluminium

Senza il codice della finitura i
tappi si intendono in alluminio
Without the finish code i
caps are made of aluminium

OPZIONALE OPTIONAL



SERVIZIO DI TAGLIO SU MISURA:

Per informazioni più dettagliate
sul servizio di taglio vedi pag. 230
CUSTOM CUT SERVICE:

For more detailed information
on the cutting service see page 230

PROFILO 4317

Applique
Applique



Scheda tecnica
Datasheet

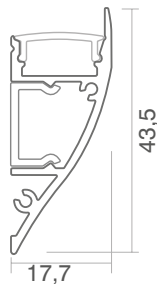

misure in mm / measurements in mm

Alluminio anodizzato
Anodized aluminum

Bianco
White

Nero
Black

LUNGHEZZA MASSIMA: 2m
MAXIMUM LENGTH: 2m

CE IP20



COMPOSIZIONE CODICE KIT KIT CODE COMPOSITION

Profilo+Diffusore+Tappi (1 chiuso e 1 aperto)+Staffa
Profile+Diffuser+Caps (1 closed and 1 open)+Bracket

COD.BASE
BASE CODE:

4317-

DIFFUSORE
DIFFUSER

O (opale/opal)
T (trasparente/transparent)

FINITURA
FINISH

00 (alluminio/aluminium)
01 (bianco/white)
02 (nero/black)

LUNGHEZZA
LENGTH

L10 (1000mm)
L20 (2000mm)

Configuratore di riferimento:
Reference configurator:

Es: **4317-002L20**

CODICI COMPONENTI SINGOLI: SINGLE COMPONENTS CODES:

PROFILO
PROFILE

COD. BASE
BASE CODE

14612-

FINITURE
FINISH

01
02

L=

L10
L20

DIFFUSORE
DIFFUSER

COD. BASE
BASE CODE

14651-
Opale
Opal

14610-
Trasparente
Transparent

L=

L10
L20

TAPPI
CAPS

COD. BASE
BASE CODE

14613- / 14614-
Sinistro/destro
Left/right

FISSAGGIO
FIXING

COD. BASE
BASE CODE

14615
Staffa L=50mm
foro ø3mm
Bracket L=50mm
hole ø3mm

Senza il codice della finitura il
profilo si intende in alluminio
Without the finish code the
profile is made of aluminium

Senza il codice della finitura i
tappi si intendono in alluminio
Without the finish code i
caps are made of aluminium

OPZIONALE OPTIONAL



SERVIZIO DI TAGLIO SU MISURA:

Per informazioni più dettagliate
sul servizio di taglio vedi pag. 230

CUSTOM CUT SERVICE:

For more detailed information
on the cutting service see page 230

PROFILO D20

Plafone
Ceiling-wall



Scheda tecnica
Datasheet

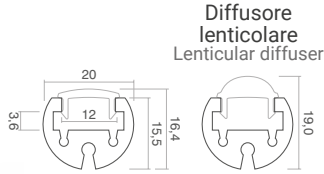

Diffusore
lenticolare
Lenticular diffuser

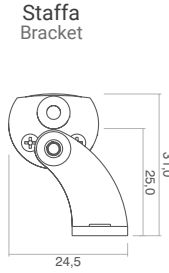

Staffa
Bracket

Installazione anche
a Sospensione
Installation also
in Suspension



misure in mm / measurements in mm

Alluminio anodizzato
Anodized aluminum

Bianco
White

Nero
Black

LUNGHEZZA MASSIMA: 4m
MAXIMUM LENGTH: 4m

CE IP20

COMPOSIZIONE CODICE KIT KIT CODE COMPOSITION

Profilo+Diffusore+Tappi (1 chiuso e 1 aperto)+Staffe DX e SX
Profile+Diffuser+Caps (1 closed and 1 open)+right and left brackets

COD.BASE
BASE CODE:

DIFFUSORE
DIFFUSER

OD20-

O (opale/opal)
T (trasparente/transparent)
S (satinato/satin)
L (Lenticolare/lenticular)

FINITURA
FINISH

00 (alluminio/aluminium)
01 (bianco/white)
02 (nero/black)

LUNGHEZZA
LENGTH

L10 (1000mm)
L20 (2000mm)
L30 (3000mm)
L40 (4000mm)

Configuratore di riferimento:
Reference configurator:

Es:OD20-000L20

Per misure superiori ai 2m è prevista una staffa di supporto centrale (cod.13082).
For sizes greater than 2m, a central support bracket is provided (code 13082).

CODICI COMPONENTI SINGOLI: SINGLE COMPONENTS CODES:

PROFILO
PROFILE

COD. BASE
BASE CODE

14029-

FINITURE
FINISH

01
02

L=

L10
L20
L30
L40

DIFFUSORE
DIFFUSER

COD. BASE
BASE CODE

14000-
Trasparente
Transparent

14001-
Opale
Opal

14445-
Satinata
Satin

14002-
Lenticolare
Lenticular

L=

L10
L20
L30
L40

TAPPI
CAPS

COD. BASE
BASE CODE

14025- / 14026-
Passacavo/chiuso
Grommet/closed

14027- / 14028-
Passacavo/chiuso lenticolari
per copertura 14002
Grommet/closed lenticular
for cover 14002

FINITURE
FINISH

01
02

FISSAGGIO
FIXING

COD. BASE
BASE CODE

14035-
Staffe SX e DX
Right and left brackets

FINITURE
FINISH

00
01
02

Senza il codice della finitura il
profilo si intende in alluminio
Without the finish code the
profile is made of aluminium

Senza il codice della finitura i
tappi si intendono in alluminio
Without the finish code i
caps are made of aluminium

13082
Staffa supporto centrale
(solo per misure L30/L40).
Central support bracket
(only for sizes L30/L40).

OPZIONALE OPTIONAL

*14071
TOUCH SMD 12~24V

*Esclusa con diffusore lenticolare
*Excluded with lenticular diffuser



SERVIZIO DI TAGLIO SU MISURA:

Per informazioni più dettagliate
sul servizio di taglio vedi pag. 230
CUSTOM CUT SERVICE:

For more detailed information
on the cutting service see page 230

PROFILO D40

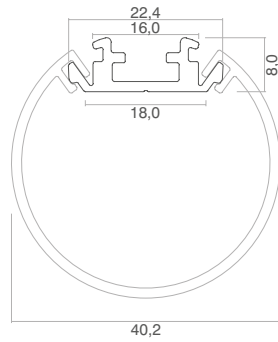

misure in mm / measurements in mm

Alluminio anodizzato
Anodized aluminum

LUNGHEZZA MASSIMA: 2m
MAXIMUM LENGTH: 2m

CE IP20

Plafone
Ceiling-wall



Sospensione
Suspension



Scheda tecnica
Datasheet



Configuratore di riferimento:
Reference configurator:

Es: **D40-000L20**

COMPOSIZIONE CODICE KIT KIT CODE COMPOSITION

Profilo+Diffusore+Tappi chiusi+2 Mollette/mt
Profile+Diffuser+Caps closed+2 Clips/mt

COD.BASE
BASE CODE:
D40-

DIFFUSORE
DIFFUSER
0 (opale/opal)

FINITURA
FINISH
00 (alluminio/aluminium)

LUNGHEZZA
LENGTH
L10 (1000mm)
L20 (2000mm)

CODICI COMPONENTI SINGOLI: SINGLE COMPONENTS CODES:

PROFILO
PROFILE
COD. BASE
BASE CODE
12008-

L=

L10
L20

DIFFUSORE
DIFFUSER
COD. BASE
BASE CODE
12009-
Opale
Opal

L=

L10
L20

TAPPI
CAPS
COD. BASE
BASE CODE
12010
Chiuso
Closed

L=

L10
L20

FISSAGGIO
FIXING
COD. BASE
BASE CODE
12011
Molletta
17,5x7,7x15mm
Clip
17,5x7,7x15mm

01
02

Senza il codice della finitura il
profilo si intende in alluminio
Without the finish code the
profile is made of aluminium

Senza il codice della finitura i
tappi si intendono in alluminio
Without the finish code i
caps are made of aluminium

OPZIONALE OPTIONAL

12012
Kit sospensione 1 cavo L=2000mm
Suspension kit 1 cable L=2000mm



SERVIZIO DI TAGLIO SU MISURA:

Per informazioni più dettagliate
sul servizio di taglio vedi pag. 230
CUSTOM CUT SERVICE:

For more detailed information
on the cutting service see page 230

Angolare

Angular

I profili angolari rappresentano la soluzione ideale per mettere in risalto oggetti o ambienti, trovando perfetta applicazione in vetrine, sotto pensili, mensole, armadiature o velette in cartongesso. La loro conformazione consente di integrarsi armoniosamente nell'angolo, aderendo alle superfici e proiettando la luce in modo preciso e centrato.

Corner profiles represent the ideal solution to highlight objects or environments, finding perfect application in showcases, under cabinets, shelves, wardrobes, or gypsum bulkheads. Their configuration allows seamless integration into the corner, adhering to surfaces and projecting light precisely and centrally.





Per applicazioni ad angolo

For corner application



Consentono la creazione di tagli di luce in angoli concavi o convessi, per sfruttare al meglio gli spazi e creare effetti di luce originali e geometrici in punti particolarmente difficili da raggiungere con altri sistemi illuminotecnici. Grazie alla loro versatilità, i profili angolari si adattano a diverse applicazioni, donando agli spazi un tocco di raffinatezza e enfatizzando gli elementi illuminati in modo incantevole.

They allow the creation of light cuts in concave or convex angles, to make the most of the spaces and create original and geometric light effects in points particularly difficult to reach with other lighting systems. Thanks to their versatility, angular profiles adapt to various applications, adding a touch of refinement to spaces and enchantingly emphasizing the illuminated elements.

PROFILO 1010

Angolare
Angular



Scheda tecnica
Datasheet

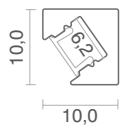

Microprofilo
Microprofile

Compatibile solo con Micro StripLED da 4mm a pag.75
Compatible only with 4mm Micro StripLED on page 75

misure in mm / measurements in mm

Alluminio anodizzato
Anodized aluminum

Bianco
White

Nero
Black

LUNGHEZZA MASSIMA: 2m
MAXIMUM LENGTH: 2m

CE IP20

COMPOSIZIONE CODICE KIT
KIT CODE COMPOSITION

Profilo+Diffusore+Tappi (1 chiuso e 1 aperto)+2 Mollette/mt
Profile+Diffuser+Caps (1 closed and 1 open)+2 Clips/mt

COD. BASE
BASE CODE:
1010-

DIFFUSORE
DIFFUSER 
0 (opale/opal)

FINITURA
FINISH 
00 (alluminio/aluminium)
01 (bianco/white)
02 (nero/black)

LUNGHEZZA
LENGTH 
L10 (1000mm)
L20 (2000mm)



Configuratore di riferimento:
Reference configurator:
Es: 1010-001L20

CODICI COMPONENTI SINGOLI:
SINGLE COMPONENTS CODES:

PROFILO
PROFILE 
COD. BASE
BASE CODE
14721-

FINITURE
FINISH 
L=

01
02

L10
L20

DIFFUSORE
DIFFUSER 
COD. BASE
BASE CODE
14727-
Opale
Opal

L=

L10
L20

TAPPI
CAPS 
COD. BASE
BASE CODE
14740- / 14739-
Passacavo/chiuso
Grommet/closed

FINITURE
FINISH 
01
02

FISSAGGIO
FIXING 
COD. BASE
BASE CODE
14744
Molletta
Clip

Senza il codice della finitura il profilo si intende in alluminio
Without the finish code the profile is made of aluminium

Senza il codice della finitura i tappi si intendono in alluminio
Without the finish code i caps are made of aluminium

OPZIONALE
OPTIONAL



SERVIZIO DI TAGLIO SU MISURA:

Per informazioni più dettagliate sul servizio di taglio vedi pag. 230

CUSTOM CUT SERVICE:

For more detailed information on the cutting service see page 230

PROFILO 1616

Angolare
Angular



Scheda tecnica
Datasheet



Diffusore
Tondo
Round diffuser

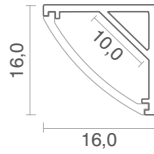

Diffusore
Quadro
Square diffuser

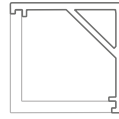

Tutta luce
All light

misure in mm / measurements in mm

Alluminio anodizzato
Anodized aluminum

LUNGHEZZA MASSIMA: 2m
MAXIMUM LENGTH: 2m

CE IP20

COMPOSIZIONE CODICE KIT
KIT CODE COMPOSITION

Profilo+Diffusore+Tappi (1 chiuso e 1 aperto)+2 Mollette/mt
Profile+Diffuser+Caps (1 closed and 1 open)+2 Clips/mt

COD. BASE
BASE CODE:
1616-

DIFFUSORE
DIFFUSER

D (tonda/round)
Q (quadra/square)

LUNGHEZZA
LENGTH

L10 (1000mm)
L20 (2000mm)



Configuratore di riferimento:
Reference configurator:
Es: 1616-QL20

CODICI COMPONENTI SINGOLI:
SINGLE COMPONENTS CODES:

PROFILO
PROFILE

COD. BASE
BASE CODE

14430-

L=

L10
L20

DIFFUSORE
DIFFUSER

COD. BASE
BASE CODE

14438-
Opale tondo
Round opal

14436-
Opale quadro
Square opal

L=

L10
L20

TAPPI
CAPS

COD. BASE
BASE CODE

14431 / 14434
Passacavo tondo/chiuso tondo
Round grommet/round closed

14433 / 14432
Passacavo quadro/chiuso quadro
Square grommet/square closed

FISSAGGIO
FIXING

COD. BASE
BASE CODE

14831
Molletta
Clip

OPZIONALE
OPTIONAL

10075
Calamita adesivizzata 15x1,2mm (50m)
Adhesive magnet 15x1,2mm (50m)

14071
TOUCH SMD 12~24V



SERVIZIO DI TAGLIO SU MISURA:

Per informazioni più dettagliate
sul servizio di taglio vedi pag. 230
CUSTOM CUT SERVICE:

For more detailed information
on the cutting service see page 230

PROFILO 2020

Angolare
Angular

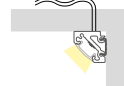

Scheda tecnica
Datasheet

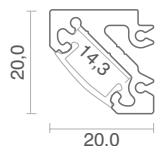

Diffusore
Lenticolare
Lenticular diffuser



misure in mm / measurements in mm

Alluminio anodizzato
Anodized aluminum

Bianco
White

Nero
Black

LUNGHEZZA MASSIMA: 4m
MAXIMUM LENGTH: 4m

CE IP20

COMPOSIZIONE CODICE KIT KIT CODE COMPOSITION

Profilo+Diffusore+Tappi (1 chiuso e 1 aperto)+2 Mollette/mt
Profile+Diffuser+Caps (1 closed and 1 open)+2 Clips/mt

COD.BASE
BASE CODE:

2020-

DIFFUSORE
DIFFUSER

O (opale/opal)
T (trasparente/transparent)
S (satinato/satin)
L (lenticolare/lenticular)

FINITURA
FINISH

00 (alluminio/aluminium)
01 (bianco/white)
02 (nero/black)

LUNGHEZZA
LENGTH

L10 (1000mm)
L20 (2000mm)
L30 (3000mm)
L40 (4000mm)

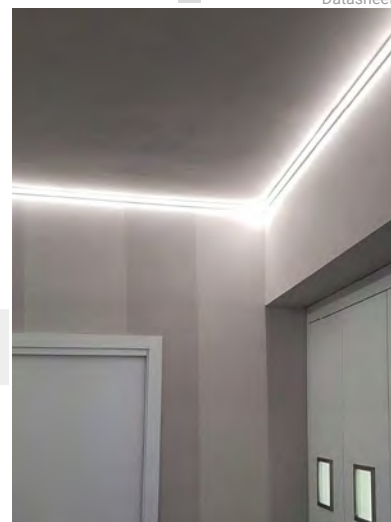

Configuratore di riferimento:
Reference configurator:

Es: 2020-001L30

CODICI COMPONENTI SINGOLI: SINGLE COMPONENTS CODES:

PROFILO
PROFILE
COD. BASE
BASE CODE
14226-

FINITURE
FINISH

01

02

L10
L20
L30
L40

DIFFUSORE
DIFFUSER
COD. BASE
BASE CODE
L=

14000-
Trasparente
Transparent

14001-
Opale
Opal

14445-
Satinata
Satin

14002-
Lenticolare
Lenticular

L10
L20
L30
L40

TAPPI
CAPS
COD. BASE
BASE CODE
14225- / 14224-
Passacavo/chiuso
Grommet/closed

14228- / 14227-
Passacavo/chiuso lenticolari - per copertura 14002
Grommet/closed lenticular- for cover 14002

FINITURE
FINISH

01

02

FISSAGGIO
FIXING
COD. BASE
BASE CODE

14185
Molletta
Clip

Senza il codice della finitura il
profilo si intende in alluminio
Without the finish code the
profile is made of aluminium

Senza il codice della finitura i
tappi si intendono in alluminio
Without the finish code i
caps are made of aluminium

OPZIONALE OPTIONAL

***03102**
PIR SMD 12~24V

***14071**
TOUCH SMD 12~24V

***Esclusa con diffusore lenticolare**
***Excluded with lenticular diffuser**



SERVIZIO DI TAGLIO SU MISURA:

Per informazioni più dettagliate
sul servizio di taglio vedi pag. 230
CUSTOM CUT SERVICE:

For more detailed information
on the cutting service see page 230

PROFILO 2115

Angolare
Angular

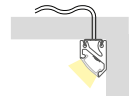

Scheda tecnica
Datasheet

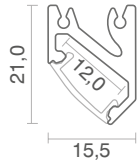

misure in mm / measurements in mm

Alluminio anodizzato
Anodized aluminum

Bianco
White

Nero
Black

LUNGHEZZA MASSIMA: 4m
MAXIMUM LENGTH: 4m

CE IP20

COMPOSIZIONE CODICE KIT KIT CODE COMPOSITION

Profilo+Diffusore+Tappi (1 chiuso e 1 aperto)+2 Mollette/mt
Profile+Diffuser+Caps (1 closed and 1 open)+2 Clips/mt

COD.BASE
BASE CODE:

2115-

DIFFUSORE
DIFFUSER

O (opale/opal)
T (trasparente/transparent)
S (satinato/satin)

FINITURA
FINISH

00 (alluminio/aluminium)
01 (bianco/white)
02 (nero/black)

LUNGHEZZA
LENGTH

L10 (1000mm)
L20 (2000mm)
L30 (3000mm)
L40 (4000mm)

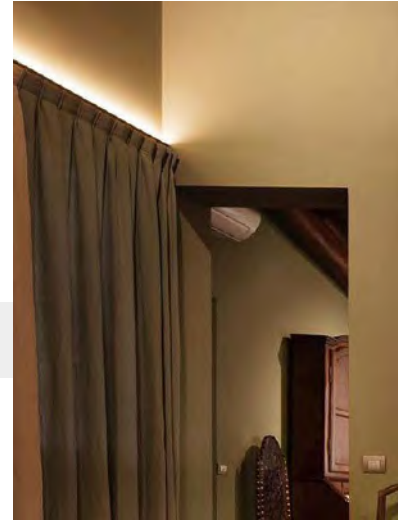

Configuratore di riferimento:
Reference configurator:

Es: 2115-S00L20

CODICI COMPONENTI SINGOLI: SINGLE COMPONENTS CODES:

PROFILO
PROFILE

COD. BASE
BASE CODE

14403-

FINITURE
FINISH

01
02

L10
L20
L30
L40

DIFFUSORE
DIFFUSER

COD. BASE
BASE CODE

14000-
Trasparente
Transparent
14001-
Opale
Opal
14445-
Satinata
Satin

L=

L10
L20
L30
L40

TAPPI
CAPS

COD. BASE
BASE CODE

14405- / 14404-
Passacavo/chiuso
Grommet/closed

FINITURE
FINISH

01
02

FISSAGGIO
FIXING

COD. BASE
BASE CODE

14185
Molletta
Clip

Senza il codice della finitura il
profilo si intende in alluminio
Without the finish code the
profile is made of aluminium

Senza il codice della finitura i
tappi si intendono in alluminio
Without the finish code i
caps are made of aluminium

OPZIONALE OPTIONAL

03102
PIR SMD 12~24V

14071
TOUCH SMD 12~24V



SERVIZIO DI TAGLIO SU MISURA:

Per informazioni più dettagliate
sul servizio di taglio vedi pag. 230
CUSTOM CUT SERVICE:

For more detailed information
on the cutting service see page 230

PROFILO 7676

Angolare
Angular

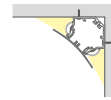

Scheda tecnica
Datasheet

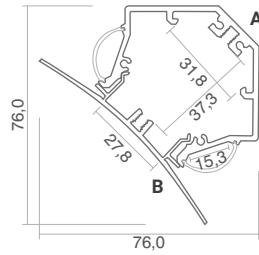

Biemissione
Biemission

A= parte posteriore in alluminio
B= parte anteriore bianca o nera
A= aluminum back
B= white or black front
misure in mm / measurements in mm

Bianco
White Nero
Black

LUNGHEZZA MASSIMA: 2m
MAXIMUM LENGTH: 2m

CE IP20

COMPOSIZIONE CODICE KIT
KIT CODE COMPOSITION

Profilo+Diffusore+Tappi chiusi
Profile+Diffuser+Caps closed

COD.BASE **DIFFUSORE**
BASE CODE: DIFFUSER
7676- **0** (opale/opal)

FINITURA
FINISH
01 (bianco/white)
02 (nero/black)

LUNGHEZZA
LENGTH
L10 (1000mm)
L20 (2000mm)



Configuratore di riferimento:
Reference configurator:
Es: 7676-001L20

CODICI COMPONENTI SINGOLI:
SINGLE COMPONENTS CODES:

PROFILO
PROFILE
COD. BASE **FINITURE** **L=**
BASE CODE FINISH
13007- **01** **L10**
02 **L20**

DIFFUSORE
DIFFUSER
COD. BASE **L=**
BASE CODE
13008- **L10**
Opale **L20**
Opal

TAPPI
CAPS
COD. BASE **FINITURE**
BASE CODE FINISH
13009- **01**
chiuso **02**
closed

OPZIONALE
OPTIONAL



SERVIZIO DI TAGLIO SU MISURA:

Per informazioni più dettagliate
sul servizio di taglio vedi pag. 230

CUSTOM CUT SERVICE:

For more detailed information
on the cutting service see page 230

PROFILO 6730

Angolare
Angular



Scheda tecnica
Datasheet

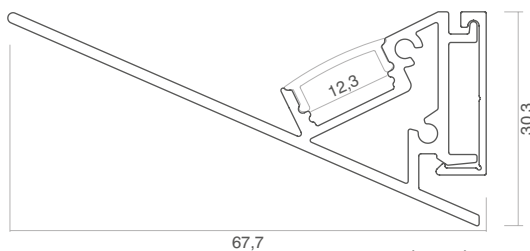

misure in mm / measurements in mm

Alluminio anodizzato
Anodized aluminum

Bianco
White

Nero
Black

LUNGHEZZA MASSIMA: 2m
MAXIMUM LENGTH: 2m

CE IP20

COMPOSIZIONE CODICE KIT KIT CODE COMPOSITION

COD. BASE
BASE CODE:
6730-

DIFFUSORE
DIFFUSER 
0 (opale/opal)

FINITURA
FINISH 
00 (alluminio/aluminium)
01 (bianco/white)
02 (nero/black)

Profilo+Diffusore+Tappi chiusi+Staffa
Profile+Diffuser+Caps closed+Bracket

LUNGHEZZA
LENGTH 
L10 (1000mm)
L20 (2000mm)



Configuratore di riferimento:
Reference configurator:
Es: 6730-001L20

CODICI COMPONENTI SINGOLI: SINGLE COMPONENTS CODES:

PROFILO
PROFILE 
COD. BASE
BASE CODE
12013-

FINITURE
FINISH 
L=

01
02

L10
L20

DIFFUSORE
DIFFUSER 
COD. BASE
BASE CODE
12014-
Opale
Opal

L=

L10
L20

TAPPI
CAPS 
COD. BASE
BASE CODE
12015-
Chiuso
Closed

FINITURE
FINISH 
L=

01
02

L10
L20

FISSAGGIO
FIXING 
COD. BASE
BASE CODE
12025-
Staffa di fissaggio
posteriore.
Rear fixing bracket.

FINITURE
FINISH 
L=

00
01
02

L10
L20

Senza il codice della finitura il
profilo si intende in alluminio
Without the finish code the
profile is made of aluminium

Senza il codice della finitura i
tappi si intendono in alluminio
Without the finish code i
caps are made of aluminium

OPZIONALE OPTIONAL



SERVIZIO DI TAGLIO SU MISURA:

Per informazioni più dettagliate
sul servizio di taglio vedi pag. 230

CUSTOM CUT SERVICE:

For more detailed information
on the cutting service see page 230

Incassi in battuta

Recessed with trim

L'incasso a battuta prevede che il corpo illuminante sia posizionato all'interno di un'apertura nel soffitto, nella parete o in altre superfici architettoniche. Tuttavia, l'apparecchio è installato in modo che una parte risalti leggermente rispetto alla superficie circostante. Questo può creare un effetto di rilievo sottolineando la forma creando un gioco di luci e ombre.

The recessed recess provides for the luminaire to be positioned inside an opening in the ceiling, wall or other architectural surfaces. However, the appliance is installed in such a way that part of it stands out slightly from the surrounding surface. This can create a prominent effect by emphasizing the shape creating a play of light and shadow.





Per soluzioni d'arredo eleganti

For elegant furnishing solutions

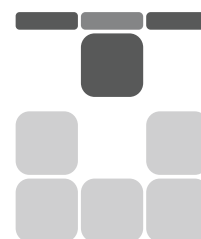

Possono essere inoltre utilizzati per creare giochi di luce e in zone architettonica dove è possibile effettuare una fresata a misura. Donano all'ambiente un aspetto elegante e originale, senza rinunciare ad un perfetto livello di illuminazione che di fatto non occupa spazio.

They can also be used to create plays of light and in architectural areas where you can make a milling to measure. They give the environment an elegant and original look, without sacrificing a perfect level of lighting that in fact does not take up space.

PROFILO 1914

Incasso a battuta
Recessed downlight

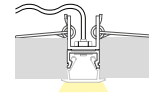

Scheda tecnica
Datasheet

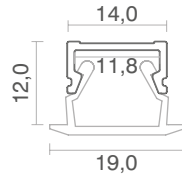

misure in mm / measurements in mm

Alluminio anodizzato
Anodized aluminum

Bianco
White

Nero
Black

LUNGHEZZA MASSIMA: 2m
MAXIMUM LENGTH: 2m

CE IP20

COMPOSIZIONE CODICE KIT
KIT CODE COMPOSITION

Profilo+Diffusore+Tappi (1 chiuso e 1 aperto)+2 Mollette/mt
Profile+Diffuser+Caps (1 closed and 1 open)+2 Clips/mt

COD. BASE
BASE CODE:

1914-

DIFFUSORE
DIFFUSER

0 (opale/opal)

FINITURA
FINISH

00 (alluminio/aluminium)
01 (bianco/white)
02 (nero/black)

LUNGHEZZA
LENGTH

L10 (1000mm)
L20 (2000mm)

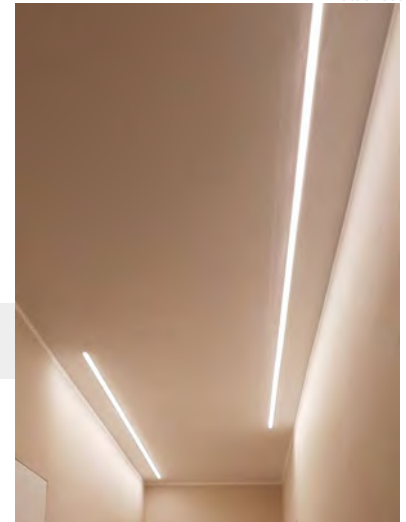

Configuratore di riferimento:
Reference configurator:
Es: 1914-001L20

CODICI COMPONENTI SINGOLI:
SINGLE COMPONENTS CODES:

PROFILO
PROFILE

COD. BASE
BASE CODE

14722-

FINITURA
FINISH

01
02

L=

L10
L20

DIFFUSORE
DIFFUSER

COD. BASE
BASE CODE

14745-
Opale
Opal

L=

L10
L20

TAPPI
CAPS

COD. BASE
BASE CODE

14746-/14747-
Passacavo/chiuso
Grommet/closed

FINITURA
FINISH

01
02

FISSAGGIO
FIXING

COD. BASE
BASE CODE

14775
Molletta
Clip

Senza il codice della finitura il profilo si intende in alluminio
Without the finish code the profile is made of aluminium

Senza il codice della finitura i tappi si intendono in alluminio
Without the finish code i caps are made of aluminium

OPZIONALE
OPTIONAL



SERVIZIO DI TAGLIO SU MISURA:

Per informazioni più dettagliate sul servizio di taglio vedi pag. 230

CUSTOM CUT SERVICE:

For more detailed information on the cutting service see page 230

PROFILO 2612

Incasso a battuta
Recessed downlight

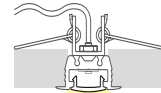

Scheda tecnica
Datasheet

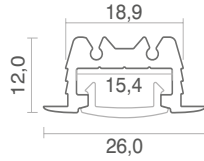

misure in mm / measurements in mm

Alluminio anodizzato
Anodized aluminum

Bianco
White

Nero
Black

LUNGHEZZA MASSIMA: 4m
MAXIMUM LENGTH: 4m

CE IP20



Configuratore di riferimento:
Reference configurator:

Es: 2612-S02L20

COMPOSIZIONE CODICE KIT

KIT CODE COMPOSITION

Profilo+Diffusore+Tappi (1 chiuso e 1 aperto)+2 Mollette/mt
Profile+Diffuser+Caps (1 closed and 1 open)+2 Clips/mt

COD.BASE
BASE CODE:

2612-

DIFFUSORE
DIFFUSER

O (opale/opal)
T (trasparente/transparent)
S (satinato/satin)

FINITURA
FINISH

00 (alluminio/aluminium)
01 (bianco/white)
02 (nero/black)

LUNGHEZZA
LENGTH

L10 (1000mm)
L20 (2000mm)
L30 (3000mm)
L40 (4000mm)

CODICI COMPONENTI SINGOLI:

SINGLE COMPONENTS CODES:

PROFILO
PROFILE

COD. BASE
BASE CODE

14201-



FINITURE
FINISH

01

02



L=

L10
L20
L30
L40

DIFFUSORE
DIFFUSER

COD. BASE
BASE CODE

14000-
Trasparente
Transparent

14001-
Opale
Opal

14445-
Satinata
Satin



L=

L10
L20
L30
L40

TAPPI
CAPS

COD. BASE
BASE CODE

14012-/14013-
Passacavo/chiuso
Grommet/closed



FINITURE
FINISH

01

02

FISSAGGIO
FIXING

COD. BASE
BASE CODE

14078
Molletta
Clip



Senza il codice della finitura il profilo si intende in alluminio
Without the finish code the profile is made of aluminium

Senza il codice della finitura i tappi si intendono in alluminio
Without the finish code i caps are made of aluminium

OPZIONALE

OPTIONAL

10807

Kit cassaforma L=2000mm+kit calamita
Formwork kit L=2000mm+magnet kit

03102

PIR SMD 12~24V

14071

TOUCH SMD 12~24V



SERVIZIO DI TAGLIO SU MISURA:

Per informazioni più dettagliate sul servizio di taglio vedi pag. 230

CUSTOM CUT SERVICE:

For more detailed information on the cutting service see page 230

PROFILO 2711

Incasso calpestabile
walkable recess



Scheda tecnica
Datasheet

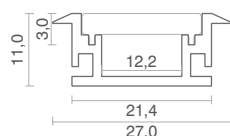

misure in mm / measurements in mm

Alluminio anodizzato
Anodized aluminum

Bianco
White

Nero
Black

LUNGHEZZA MASSIMA: 2m
MAXIMUM LENGTH: 2m

CE IP20

COMPOSIZIONE CODICE KIT

KIT CODE COMPOSITION

Profilo+Diffusore+Tappi (1 chiuso e 1 aperto)
Profile+Diffuser+Caps (1 closed and 1 open)

COD.BASE
BASE CODE:

2711-

DIFFUSORE
DIFFUSER

0 (opale/opal)

FINITURA
FINISH

00 (alluminio/aluminium)
01 (bianco/white)
02 (nero/black)

LUNGHEZZA
LENGTH

L10 (1000mm)
L20 (2000mm)

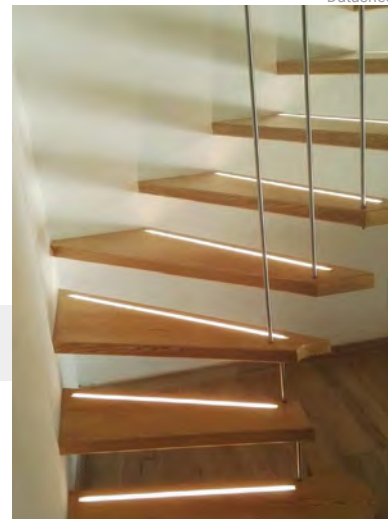

Configuratore di riferimento:
Reference configurator:
Es: 2711-001L20

CODICI COMPONENTI SINGOLI:

SINGLE COMPONENTS CODES:

PROFILO
PROFILE

COD. BASE
BASE CODE

14543-

FINITURE
FINISH

01
02

L=

L10
L20

DIFFUSORE
DIFFUSER

COD. BASE
BASE CODE

14544-
opale/opal

L=

L10
L20

TAPPI
CAPS

COD. BASE
BASE CODE

14545-/14546-
Passacavo/chiuso
Grommet/closed

FINITURE
FINISH

01
02

Senza il codice della finitura il
profilo si intende in alluminio
Without the finish code the
profile is made of aluminium

Senza il codice della finitura i
tappi si intendono in alluminio
Without the finish code i
caps are made of aluminium

OPZIONALE

OPTIONAL

10966
Cassaforma per muratura L=1998mm
Formwork for masonry L=1998mm



SERVIZIO DI TAGLIO SU MISURA:

Per informazioni più dettagliate
sul servizio di taglio vedi pag. 230

CUSTOM CUT SERVICE:

For more detailed information
on the cutting service see page 230

PROFILO 4240

Incasso in battuta
Recessed downlight



Scheda tecnica
Datasheet

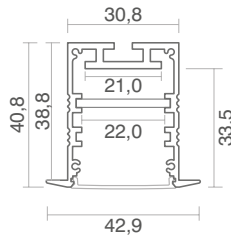
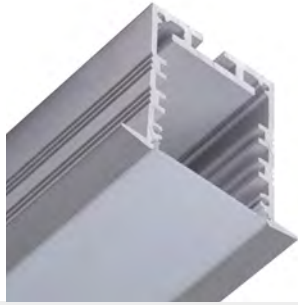
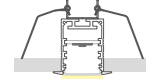

Possibilità doppia stripLED
Double stripLED option

Possibilità alim. interno
Possibility of internal power supply

misure in mm / measurements in mm

Alluminio anodizzato
Anodized aluminum

Bianco
White

Nero
Black

LUNGHEZZA MASSIMA: 4m
MAXIMUM LENGTH: 4m

CE IP20

COMPOSIZIONE CODICE KIT

KIT CODE COMPOSITION

Profilo+Diffusore+Tappi (1 chiuso e 1 aperto)+Dissipatore+2 Mollette
Profile+Diffuser+Caps (1 closed and 1 open)+Dissipator+2 Clips/mft

COD.BASE
BASE CODE:
4240-

DIFFUSORE
DIFFUSER 
0 (opale/opal)

FINITURA
FINISH 
00 (alluminio/aluminium)
01 (bianco/white)
02 (nero/black)

LUNGHEZZA
LENGTH 
L10 (1000mm)
L20 (2000mm)
L30 (3000mm)
L40 (4000mm)



Configuratore di riferimento:
Reference configurator:
Es: 4240-000L20

CODICI COMPONENTI SINGOLI:

SINGLE COMPONENTS CODES:

PROFILO
PROFILE 
COD. BASE
BASE CODE
14402-

FINITURE
FINISH 
L=

01
02

L10
L20
L30
L40

DIFFUSORE
DIFFUSER 
COD. BASE
BASE CODE
14018-
Opale
Opal

L=

L10
L20
L30
L40

TAPPI
CAPS 
COD. BASE
BASE CODE
14406- / 14407-
Passacavo/chiuso
Grommet/closed

FINITURE
FINISH 
L=

01
02

DISSIPATORE
DISSIPATOR 
COD. BASE
BASE CODE
14456-
Dissipatore interno
25x2mm
Internal dissipator
25x2mm

L=

L10
L20
L30
L40

FISSAGGIO
FIXING 
COD. BASE
BASE CODE
14408
Staffa a molla
per fissaggio a
cartongesso.
Spring bracket
for fixing a
drywall.

Senza il codice della finitura il profilo si intende in alluminio
Without the finish code the profile is made of aluminium

Senza il codice della finitura i tappi si intendono in alluminio
Without the finish code i caps are made of aluminium

OPZIONALE

OPTIONAL

4240-P4
Giunto lineare in alluminio
Aluminum linear joint

4240-P1
Giunto angolare in alluminio
Aluminum angular joint



SERVIZIO DI TAGLIO SU MISURA:

Per informazioni più dettagliate sul servizio di taglio vedi pag. 230

CUSTOM CUT SERVICE:

For more detailed information on the cutting service see page 230

PROFILO 6635

Incasso in battuta
Recessed downlight

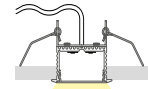

Scheda tecnica
Datasheet

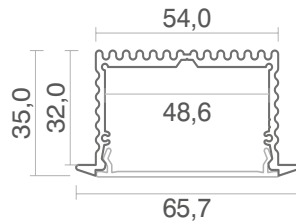

misure in mm / measurements in mm

Alluminio anodizzato
Anodized aluminum

Bianco
White

Nero
Black

LUNGHEZZA MASSIMA: 4m
MAXIMUM LENGTH: 4m

CE IP20

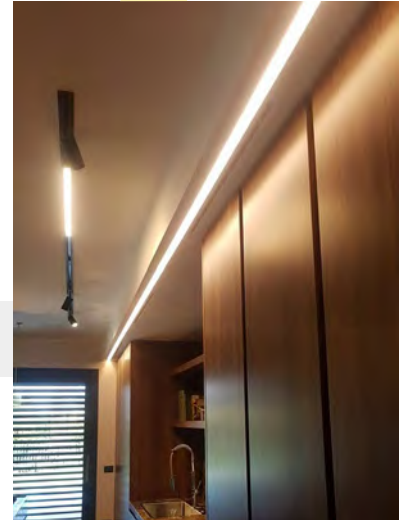

Configuratore di riferimento:
Reference configurator:
Es: 6635-000L40

COMPOSIZIONE CODICE KIT

KIT CODE COMPOSITION

Profilo+Diffusore+Tappi (1 chiuso e 1 aperto)+2 Mollette/mt
Profile+Diffuser+Caps (1 closed and 1 open)+2 Clips/mt

COD.BASE
BASE CODE:

6635-

DIFFUSORE
DIFFUSER

- O** (opale/opal)
- T** (trasparente/transparent)
- *P** (prismatizzato UGR19/prismatic)

FINITURA
FINISH

- 00** (alluminio/aluminium)
- 01** (bianco/white)
- 02** (nero/black)

LUNGHEZZA
LENGTH

- *L10** (1000mm)
- *L20** (2000mm)
- L30** (3000mm)
- L40** (4000mm)

***P:** disponibile solo L10/L20 / ***P:** available only L10/L20

CODICI COMPONENTI SINGOLI:

SINGLE COMPONENTS CODES:

PROFILO
PROFILE

COD. BASE
BASE CODE

14344-

FINITURE
FINISH

01
02

L=

L10
L20
L30
L40

DIFFUSORE
DIFFUSER

COD. BASE
BASE CODE

14037-
Opale
Opal

14019-
Trasparente
Transparent

***14573-**
Prismatizzata
Prismatic

L=

***L10**
***L20**
L30
L40

TAPPI
CAPS

COD. BASE
BASE CODE

14346- / 14347-
Passacavo/chiuso
Grommet/closed

FINITURE
FINISH

01
02

FISSAGGIO
FIXING

COD. BASE
BASE CODE

14348
Molletta
Clip

Senza il codice della finitura il profilo si intende in alluminio
Without the finish code the profile is made of aluminium

Senza il codice della finitura i tappi si intendono in alluminio
Without the finish code i caps are made of aluminium

OPZIONALE

OPTIONAL

14037-20M
Diffusore opale lucido L=20m
Glossy opal diffuser L=20m



SERVIZIO DI TAGLIO SU MISURA:

Per informazioni più dettagliate sul servizio di taglio vedi pag. 230
CUSTOM CUT SERVICE:

For more detailed information on the cutting service see page 230

PROFILO 5814

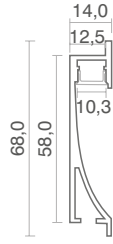

Molletta già assemblata con il profilo
Clip already assembled with the profile

misure in mm / measurements in mm

Incasto in battuta
Recessed downlight



Scheda tecnica
Datasheet

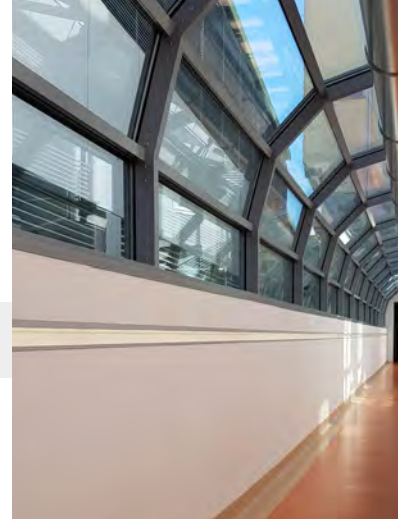

Configuratore di riferimento:
Reference configurator:
Es: 5814-002L20

Alluminio anodizzato
Anodized aluminum

Bianco
White

Nero
Black

LUNGHEZZA MASSIMA: 2m
MAXIMUM LENGTH: 2m

CE IP20

COMPOSIZIONE CODICE KIT
KIT CODE COMPOSITION

Profilo+Diffusore+Tappi (1 chiuso e 1 aperto)+2 Mollette/mt
Profile+Diffuser+Caps (1 closed and 1 open)+2 Clips/mt

COD. BASE
BASE CODE: **5814-**

DIFFUSORE
DIFFUSER **0** (opale/opal)

FINITURA
FINISH **00** (alluminio/aluminium)
01 (bianco/white)
02 (nero/black)

LUNGHEZZA
LENGTH **L10** (1000mm)
L20 (2000mm)

CODICI COMPONENTI SINGOLI:
SINGLE COMPONENTS CODES:

PROFILO
PROFILE **L=**
COD. BASE
BASE CODE **14670-**
01
02
L10
L20

DIFFUSORE
DIFFUSER **L=**
COD. BASE
BASE CODE **14669-**
opale/opal
L10
L20

TAPPI
CAPS **L=**
COD. BASE
BASE CODE **14671- / 14672-**
Passacavo/chiuso
Grommet/closed

FINITURE
FINISH **01**
02

FISSAGGIO
FIXING **01**
COD. BASE
BASE CODE **14673**
Molletta
Clip

Senza il codice della finitura il profilo si intende in alluminio
Without the finish code the profile is made of aluminium

Senza il codice della finitura i tappi si intendono in alluminio
Without the finish code i caps are made of aluminium

OPZIONALE
OPTIONAL



SERVIZIO DI TAGLIO SU MISURA:

Per informazioni più dettagliate sul servizio di taglio vedi pag. 230

CUSTOM CUT SERVICE:

For more detailed information on the cutting service see page 230

PROFILO 3537 - Luce recessa

Deeply recessed

Incasso in battuta
Recessed downlight

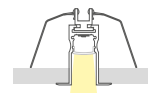

Scheda tecnica
Datasheet

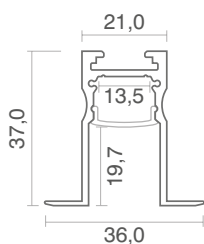

UGR<19

misure in mm / measurements in mm

Alluminio anodizzato
Anodized aluminum

Bianco
White

Nero
Black

LUNGHEZZA MASSIMA: 2m
MAXIMUM LENGTH: 2m

CE IP20

COMPOSIZIONE CODICE KIT
KIT CODE COMPOSITION

Profilo+Diffusore+Tappi (1 chiuso e 1 aperto)+2 Mollette/mt
Profile+Diffuser+Caps (1 closed and 1 open)+2 Clips/mt

COD.BASE
BASE CODE:
3537-

DIFFUSORE
DIFFUSER 
0 (opale/opal)

FINITURA
FINISH 
00 (alluminio/aluminium)
01 (bianco/white)
02 (nero/black)

LUNGHEZZA
LENGTH 
L10 (1000mm)
L20 (2000mm)



Configuratore di riferimento:
Reference configurator:

Es: 3537-002L20

CODICI COMPONENTI SINGOLI:
SINGLE COMPONENTS CODES:

PROFILO
PROFILE 
COD. BASE
BASE CODE
14844-

FINITURE
FINISH 
L=

01
02

L10
L20

DIFFUSORE
DIFFUSER 
COD. BASE
BASE CODE
14846-
Opale/opal

L=

L10
L20

TAPPI
CAPS 
COD. BASE
BASE CODE
14845P- / 14845C-
Passacavo/chiuso
Grommet/closed

FINITURE
FINISH 
01
02

FISSAGGIO
FIXING 
COD. BASE
BASE CODE
14848
Molletta
Clip

Senza il codice della finitura il
profilo si intende in alluminio
Without the finish code the
profile is made of aluminium

Senza il codice della finitura i
tappi si intendono in alluminio
Without the finish code i
caps are made of aluminium

OPZIONALE
OPTIONAL



SERVIZIO DI TAGLIO SU MISURA:

Per informazioni più dettagliate
sul servizio di taglio vedi pag. 230
CUSTOM CUT SERVICE:

For more detailed information
on the cutting service see page 230



Drywalls

Il sistema Drywall rappresenta una nuova gamma di profili che offre la possibilità di creare composizioni di pannelli di diversi materiali, consentendo tagli di luce continui, sia ad angolo che incrociati.

The Drywall system represents a new range of profiles that allows for creating compositions of panels with different materials, enabling continuous cuts of light, both at angles and intersections.



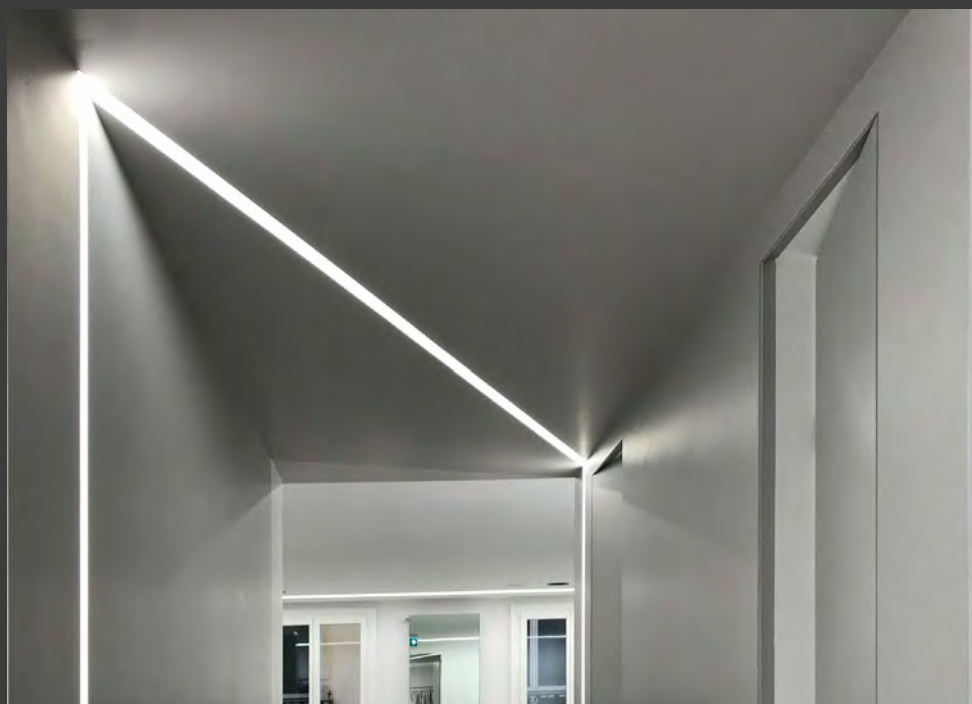

Installazioni su cartongesso

Installation on Plasterboard

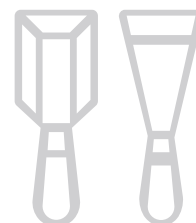

Questi profili sono costituiti da un sistema lineare in alluminio estruso, integrato in due pannelli di cartongesso a filo per alloggiare le nostre StripLED. Sono disponibili in diversi materiali, a seconda delle caratteristiche richieste. Il cartongesso idrorepellente consente di limitare l'assorbimento dell'umidità grazie a uno speciale trattamento a cui viene sottoposta la lastra. La cover nera ha la particolare proprietà di apparire nera quando i LED sono spenti, ma una volta accesi i LED, assume il colore tipico della StripLED scelta.

These profiles are made of an extruded aluminum linear system, integrated into two flush plasterboard panels to accommodate our LED Strips. They are available in various materials, depending on the required characteristics. For instance, hydro-repellent plasterboard allows limiting moisture absorption due to a special treatment applied to the panel. The black cover possesses the unique property of appearing black when the LEDs are turned off, but once the LEDs are switched on, it takes on the typical color of the chosen LED Strips.

PROFILO 1707 DRYWALL



Scheda tecnica
Datasheet

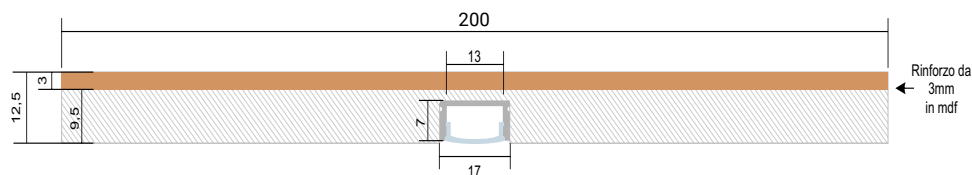

Configuratore di riferimento:
Reference configurator:
Es: 1707-BIDL20

COMPOSIZIONE CODICE KIT KIT CODE COMPOSITION

COD.BASE
BASE CODE:
1707-

DIFFUSORE
DIFFUSER 

O (opale/opal)
B (nera/black)

CARTONGESSO
PLASTBOARD

ST (standard/standard)
ID (idro/idro)

LUNGHEZZA
LENGTH 

L20 (2000mm)

14001-L40
Copertura di ricambio da 4000mm
Replacement cover da 4000mm

DIFFUSORE 
DIFFUSER

COVER OPALE
OPAL COVER



COVER NERA
BLACK COVER

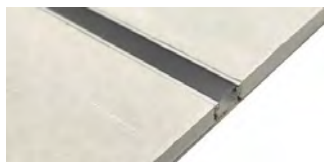

CARTONGESSO
PLASTBOARD

STANDARD
STANDARD



IDRO
IDRO

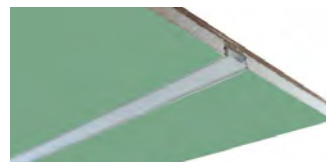

I Drywall sono una nuova gamma di profili che permette di creare composizioni a pannelli di diverso materiale con tagli di luce continui a luce angolare e incrociata. Questi profili sono costituiti da un sistema lineare in alluminio estruso integrato in due pannelli di cartongesso per incasso a raso per alloggiare StripLED Elcom. I pannelli sono disponibili in diversi materiali a seconda delle caratteristiche richieste. Il cartongesso idrorepellente permette di limitare l'assorbimento dell'umidità grazie ad uno speciale trattamento a cui viene sottoposta la lastra.

La Black cover invece possiede la particolare proprietà di risultare nera a LED spenti mentre una volta accesi i LED assume il colore tipico della StripLed scelta.

Drywall are a new range of profiles that allows you to create panel compositions of different materials with continuous light cuts at angular and cross light. These profiles consist of a linear extruded aluminum system integrated into two satin recessed plasterboard panels to house StripLED Elcom. The panels are available in different materials depending on the required characteristics. The water-repellent plasterboard allows to limit the absorption of moisture thanks to a special treatment to which the sheet is subjected.

The Black cover instead has the particular property of being black when the LEDs are turned off while once the LEDs are turned on it takes on the typical color of the StripLed choice.

OPZIONALE OPTIONAL

TAGLI DI LUCE
LIGHTS CUTS

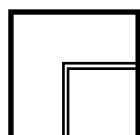

1707-2T
luce angolare/angular light

1707-2T-IDRO
idro luce angolare/ idro angular light

200x200mm

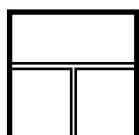

1707-3T
luce incrociata/cross light

1707-3T-IDRO
idro luce incrociata/ idro cross light

200x200mm

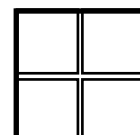

1707-4T
luce a croce/cross light

1707-4T-IDRO
idro luce a croce/ idro cross light

200x200mm

PROFILO 3011 DRYWALL



Scheda tecnica
Datasheet

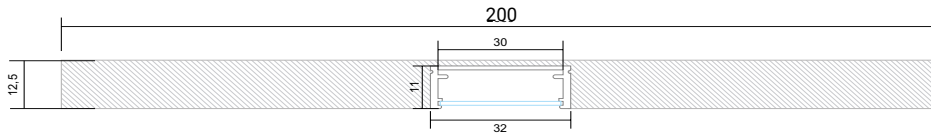

Configuratore di riferimento:
Reference configurator:

Es: 3011-OIDL20

COMPOSIZIONE CODICE KIT KIT CODE COMPOSITION

COD.BASE
BASE CODE:

3011-

DIFFUSORE
DIFFUSER

O (opale/opal)

CARTONGESSO
PLASTBOARD

ST (standard/standard)
ID (idro/idro)

LUNGHEZZA
LENGTH

L20 (2000mm)

14960
Copertura di ricambio da 2000mm
Replacement cover da 2000mm

DIFFUSORE
DIFFUSER



COVER OPALE
OPAL COVER

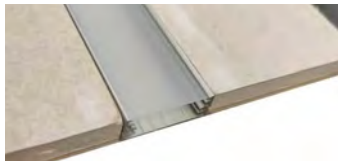

CARTONGESSO
PLASTBOARD

STANDARD
STANDARD



IDRO
IDRO



I profili 3011 Drywall differiscono dalla versione 1707 avendo un profilo più largo, questo permette di poter inserire al loro interno due StripLED invece di una, permettendo di creare installazioni con una potenza luminosa maggiore.

The 3011 Drywall profile differ from the 1707 version by having a wider profile, this allows you to insert two StripLED instead of one, allowing you to create installations with a higher light output.

OPZIONALE OPTIONAL

TAGLI DI LUCE
LIGHTS CUTS

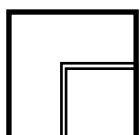

3011-2T
luce angolare/angular light

3011-2T-IDRO
idro luce angolare/ idro angular light

200x200mm

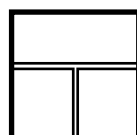

3011-3T
luce incrociata/cross light

3011-3T-IDRO
idro luce incrociata/ idro cross light

200x200mm

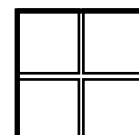

3011-4T
luce a croce/cross light

3011-4T-IDRO
idro luce a croce/ idro cross light

200x200mm

Incassi a raso

Recessed flush and trimless

I profili da incasso sono la soluzione perfetta per creare un'illuminazione elegante e raffinata. Si nascondono nell'architettura per dare valore alla luce e possono essere utilizzati per realizzare tagli di luce su pareti o soffitti con il massimo della versatilità.

Recessed profiles are the perfect solution for creating elegant and refined lighting. They blend seamlessly into the architecture, enhancing the value of light, and can be used to create light cuts on walls or ceilings with maximum versatility.

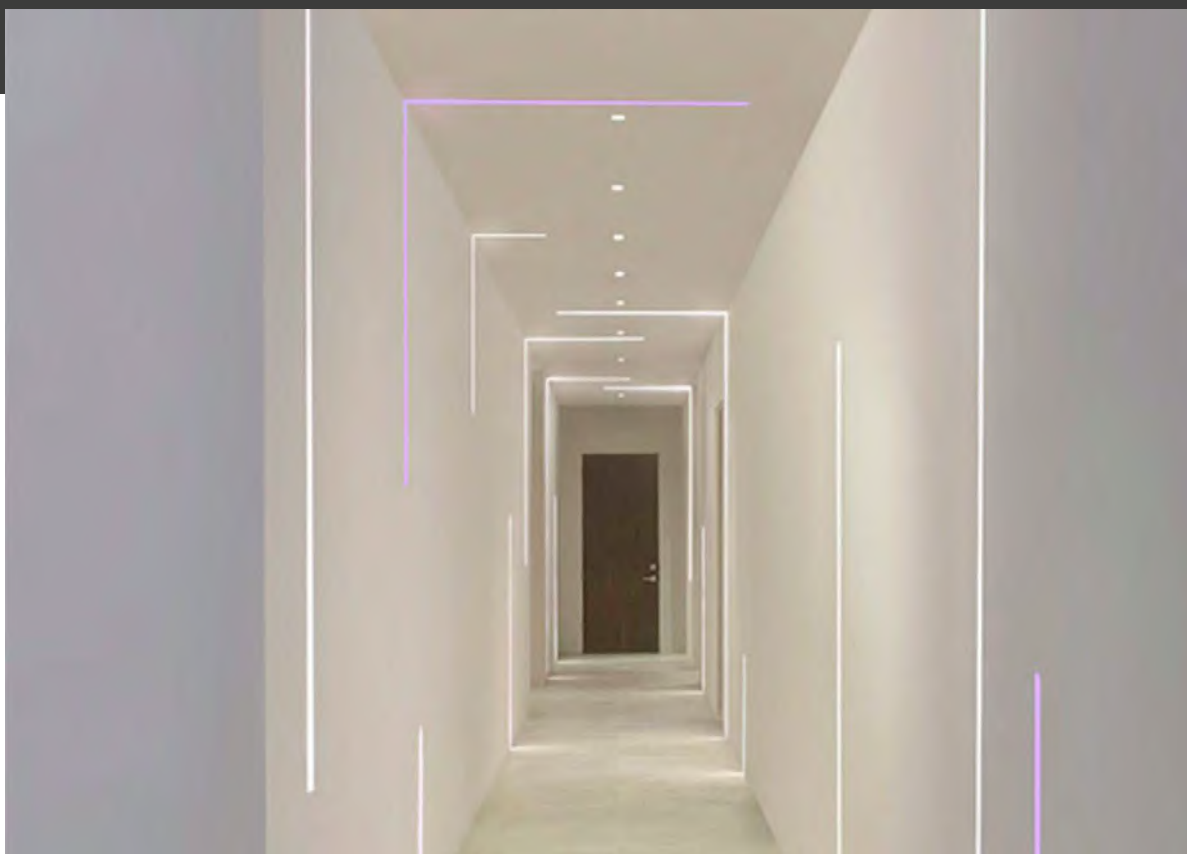



Per soluzioni d'arredo eleganti

For elegant furnishing solutions



Possono essere inoltre utilizzati per creare composizioni lineari con cornice e profilo a vista oppure trimless, per un design fluido ed essenziale, sia su cartongesso che in muratura. Gli spessori ridotti e la sorprendente uniformità luminosa catturano lo sguardo in un percorso infinito.

Moreover, they can be used to design linear compositions with visible frame and profile or trimless, for a fluid and essential design, both on plasterboard and masonry. The slim thicknesses and the astonishing luminous uniformity capture the gaze in an infinite path.

PROFILO 4812

Incasso a raso
Flush recessed



Scheda tecnica
Datasheet

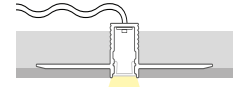

Compatibile solo con Micro StripLED da 4mm a pag.75
Compatible only with 4mm Micro StripLED on page 75

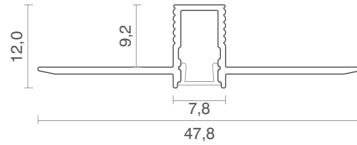
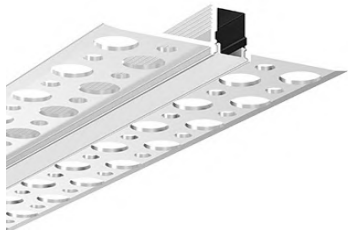

misure in mm / measurements in mm

Alluminio anodizzato
Anodized aluminum

LUNGHEZZA MASSIMA: 2m
MAXIMUM LENGTH: 2m

CE IP20

COMPOSIZIONE CODICE KIT
KIT CODE COMPOSITION

Profilo+Diffusore+Tappi (1 chiuso e 1 aperto)
Profile+Diffuser+Caps (1 closed and 1 open)

COD. BASE
BASE CODE:
4812-

DIFFUSORE
DIFFUSER
0 (opale/opal)

FINITURA
FINISH
00 (alluminio/aluminium)

LUNGHEZZA
LENGTH
L10 (1000mm)
L20 (2000mm)



Configuratore di riferimento:
Reference configurator:
Es: 4812-000L20

CODICI COMPONENTI SINGOLI:
SINGLE COMPONENTS CODES:

PROFILO
PROFILE
COD. BASE
BASE CODE
14723-

L=
L10
L20

DIFFUSORE
DIFFUSER
COD. BASE
BASE CODE
14727-
opale/opal

L=
L10
L20

TAPPI
CAPS
COD. BASE
BASE CODE
14743/14742
Passacavo/chiuso
Grommet/closed

OPZIONALE
OPTIONAL



SERVIZIO DI TAGLIO SU MISURA:

Per informazioni più dettagliate sul servizio di taglio vedi pag. 230

CUSTOM CUT SERVICE:

For more detailed information on the cutting service see page 230

PROFILO 5319

Incasso a raso
Flush recessed



Scheda tecnica
Datasheet

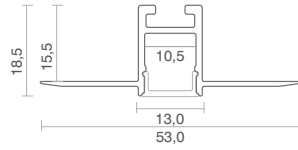
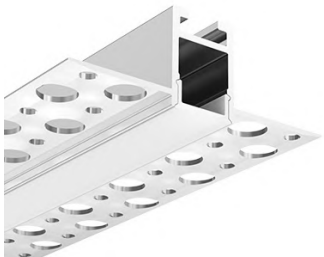

misure in mm / measurements in mm

Alluminio anodizzato
Anodized aluminum

LUNGHEZZA MASSIMA: 2m
MAXIMUM LENGTH: 2m

CE IP20



Configuratore di riferimento:
Reference configurator:

Es: 5319-000L20

COMPOSIZIONE CODICE KIT KIT CODE COMPOSITION

Profilo+Diffusore+Tappi (1 chiuso e 1 aperto)
Profile+Diffuser+Caps (1 closed and 1 open)

COD.BASE
BASE CODE: **5319-**

DIFFUSORE
DIFFUSER **0** (opale/opal)

FINITURA
FINISH **00** (alluminio/aluminium)

LUNGHEZZA
LENGTH **L10** (1000mm)
L20 (2000mm)

CODICI COMPONENTI SINGOLI: SINGLE COMPONENTS CODES:

PROFILO
PROFILE

COD. BASE
BASE CODE **14494-**

L10
L20

DIFFUSORE
DIFFUSER

COD. BASE
BASE CODE **14633-**
opale/opal

L10
L20

TAPPI
CAPS

COD. BASE
BASE CODE **14547/14548**
Passacavo/chiuso
Grommet/closed

OPZIONALE OPTIONAL

14071
TOUCH SMD 12~24V



SERVIZIO DI TAGLIO SU MISURA:

Per informazioni più dettagliate
sul servizio di taglio vedi pag. 230

CUSTOM CUT SERVICE:

For more detailed information
on the cutting service see page 230

PROFILO 6212

Incasso a raso
Flush recessed



Scheda tecnica
Datasheet

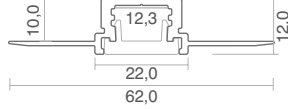
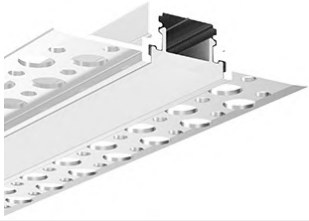

misure in mm / measurements in mm

Alluminio anodizzato
Anodized aluminum

LUNGHEZZA MASSIMA: 2m
MAXIMUM LENGTH: 2m

CE IP20

COMPOSIZIONE CODICE KIT KIT CODE COMPOSITION

Profilo+Diffusore+Tappi (1 chiuso e 1 aperto)
Profile+Diffuser+Caps (1 closed and 1 open)

COD.BASE
BASE CODE:
6212-

DIFFUSORE
DIFFUSER
0 (opale/opal)

FINITURA
FINISH
00 (alluminio/aluminium)

LUNGHEZZA
LENGTH
L10 (1000mm)
L20 (2000mm)

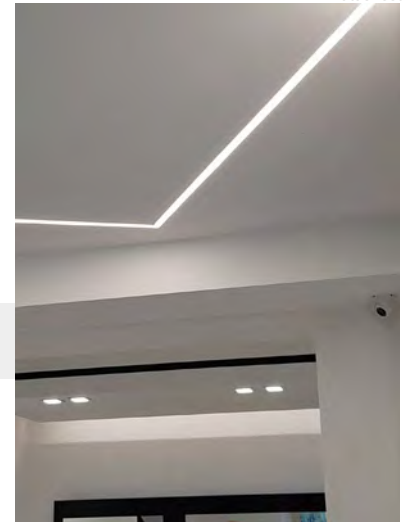

Configuratore di riferimento:
Reference configurator:
Es: 6212-000L20

CODICI COMPONENTI SINGOLI: SINGLE COMPONENTS CODES:

PROFILO
PROFILE
COD. BASE
BASE CODE
14726-

L=

L10
L20

DIFFUSORE
DIFFUSER
COD. BASE
BASE CODE
14737-
opale/opal

L=

L10
L20

TAPPI
CAPS
COD. BASE
BASE CODE
14735/14736
passacavo/chiuso
grommet/closed

OPZIONALE OPTIONAL



SERVIZIO DI TAGLIO SU MISURA:

Per informazioni più dettagliate
sul servizio di taglio vedi pag. 230

CUSTOM CUT SERVICE:

For more detailed information
on the cutting service see page 230

PROFILO 6214

Incasso a raso
Flush recessed



Scheda tecnica
Datasheet



**DISPONIBILE DIFFUSORE
FINO A 10M**
DIFFUSER AVAILABLE UP
TO 10M

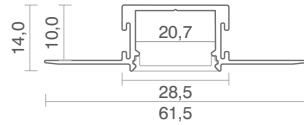
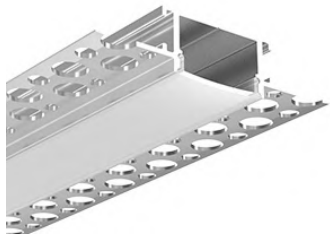

misure in mm / measurements in mm

Alluminio anodizzato
Anodized aluminum

LUNGHEZZA MASSIMA: 3m
MAXIMUM LENGTH: 3m

CE IP20

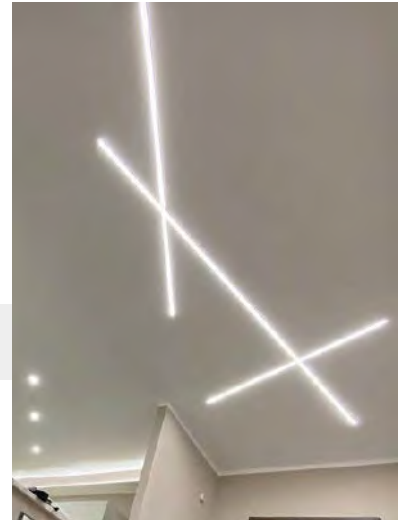

Configuratore di riferimento:
Reference configurator:
Es: 6214-000L20

COMPOSIZIONE CODICE KIT

KIT CODE COMPOSITION

Profilo+Diffusore+Tappi (1 chiuso e 1 aperto)
Profile+Diffuser+Caps (1 closed and 1 open)

COD. BASE
BASE CODE: **6214-**

DIFFUSORE
DIFFUSER **0** (opale/opal)

FINITURA
FINISH **00** (alluminio/aluminium)

LUNGHEZZA
LENGTH
L10 (1000mm)
L20 (2000mm)
L30 (3000mm)

CODICI COMPONENTI SINGOLI:

SINGLE COMPONENTS CODES:

PROFILO
PROFILE
COD. BASE
BASE CODE
14697-

L10
L20
L30

DIFFUSORE
DIFFUSER
COD. BASE
BASE CODE
14698-
opale/opal

L10
L20
L30

TAPPI
CAPS
COD. BASE
BASE CODE
14710/14699
passacavo/chiuso
grommet/closed

OPZIONALE

OPTIONAL

14698-10M
Diffusore opale 10m
Opal diffuser 10m



SERVIZIO DI TAGLIO SU MISURA:

Per informazioni più dettagliate
sul servizio di taglio vedi pag. 230

CUSTOM CUT SERVICE:

For more detailed information
on the cutting service see page 230

PROFILO 6414

Incasso a raso
Flush recessed

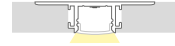

Scheda tecnica
Datasheet

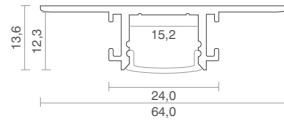

misure in mm / measurements in mm

Alluminio anodizzato
Anodized aluminum

LUNGHEZZA MASSIMA: 2m
MAXIMUM LENGTH: 2m

CE IP20

COMPOSIZIONE CODICE KIT
KIT CODE COMPOSITION

Profilo+Diffusore+Tappi (1 chiuso e 1 aperto)
Profile+Diffuser+Caps (1 closed and 1 open)

COD. BASE **DIFFUSORE**
BASE CODE: DIFFUSER
6414- **0** (opale/opal)

FINITURA
FINISH
00 (alluminio/aluminium)

LUNGHEZZA
LENGTH
L10 (1000mm)
L20 (2000mm)



Configuratore di riferimento:
Reference configurator:
Es: 6414-000L20

CODICI COMPONENTI SINGOLI:
SINGLE COMPONENTS CODES:

PROFILO
PROFILE
COD. BASE
BASE CODE
14803-
L10
L20

DIFFUSORE
DIFFUSER
COD. BASE
BASE CODE
14804-
opale/opal
L10
L20

TAPPI
CAPS
COD. BASE
BASE CODE
14806/14805
passacavo/chiuso
grommet/closed

OPZIONALE
OPTIONAL

SERVIZIO DI TAGLIO SU MISURA:
Per informazioni più dettagliate
sul servizio di taglio vedi pag. 230
CUSTOM CUT SERVICE:
For more detailed information
on the cutting service see page 230

PROFILO 8819

Incasso a raso
Flush recessed



Scheda tecnica
Datasheet

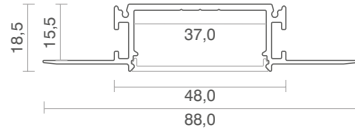

Possibilità doppia stripLED
Double stripLED option

misure in mm / measurements in mm

Alluminio anodizzato
Anodized aluminum

LUNGHEZZA MASSIMA: 2m
MAXIMUM LENGTH: 2m

CE IP20

COMPOSIZIONE CODICE KIT
KIT CODE COMPOSITION

Profilo+Diffusore+Tappi (1 chiuso e 1 aperto)
Profile+Diffuser+Caps (1 closed and 1 open)

COD.BASE
BASE CODE:
8819-

DIFFUSORE
DIFFUSER
0 (opale/opal)

FINITURA
FINISH
00 (alluminio/aluminium)

LUNGHEZZA
LENGTH
L10 (1000mm)
L20 (2000mm)

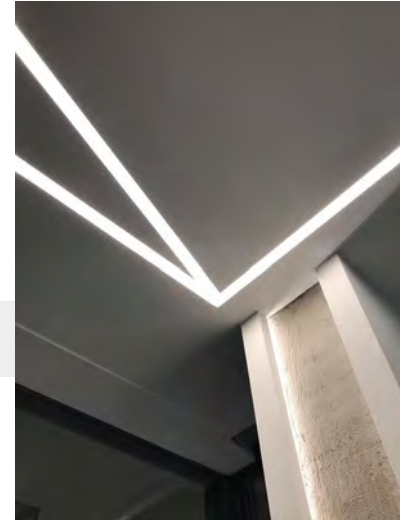

Configuratore di riferimento:
Reference configurator:
Es: 8819-000L20

CODICI COMPONENTI SINGOLI:
SINGLE COMPONENTS CODES:

PROFILO
PROFILE
COD. BASE
BASE CODE
14493-

L=

L10
L20

DIFFUSORE
DIFFUSER
COD. BASE
BASE CODE
14533-
opale/opal

L=

L10
L20

TAPPI
CAPS
COD. BASE
BASE CODE
14560/14559
passacavo/chiuso
grommet/closed

OPZIONALE
OPTIONAL



SERVIZIO DI TAGLIO SU MISURA:

Per informazioni più dettagliate
sul servizio di taglio vedi pag. 230

CUSTOM CUT SERVICE:

For more detailed information
on the cutting service see page 230

PROFILO 9819

Incasso a raso
Flush recessed



Scheda tecnica
Datasheet

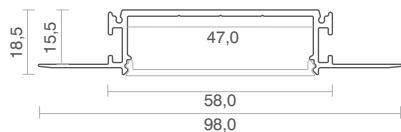

misure in mm / measurements in mm

CE IP20

COMPOSIZIONE CODICE KIT KIT CODE COMPOSITION

COD.BASE
BASE CODE:
9819-

DIFFUSORE
DIFFUSER 
0 (opale/opal)

FINITURA
FINISH 
00 (alluminio/aluminium)

LUNGHEZZA
LENGTH 
L10 (1000mm)
L20 (2000mm)

Profilo+Diffusore+Tappi (1 chiuso e 1 aperto)
Profile+Diffuser+Caps (1 closed and 1 open)

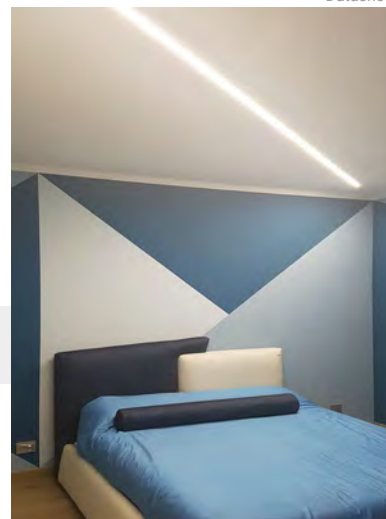

Configuratore di riferimento:
Reference configurator:
Es: 9819-000L20

CODICI COMPONENTI SINGOLI: SINGLE COMPONENTS CODES:

PROFILO
PROFILE 
COD. BASE
BASE CODE
14492-

L=

L10
L20

DIFFUSORE
DIFFUSER 
COD. BASE
BASE CODE
14497-
opale/opal

L=

L10
L20

TAPPI
CAPS 
COD. BASE
BASE CODE
14549/14552
passacavo/chiuso
grommet/closed

OPZIONALE OPTIONAL



SERVIZIO DI TAGLIO SU MISURA:

Per informazioni più dettagliate
sul servizio di taglio vedi pag. 230
CUSTOM CUT SERVICE:

For more detailed information
on the cutting service see page 230



PROFILO 2351

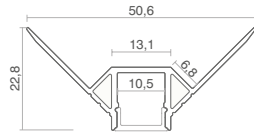
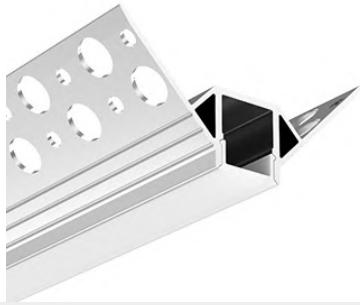

misure in mm / measurements in mm

 Alluminio anodizzato
Anodized aluminum

LUNGHEZZA MASSIMA: 2m
MAXIMUM LENGTH: 2m

CE IP20

COMPOSIZIONE CODICE KIT KIT CODE COMPOSITION

COD. BASE
BASE CODE:
2351-

DIFFUSORE
DIFFUSER 
0 (opale/opal)

FINITURA
FINISH 
00 (alluminio/aluminium)

LUNGHEZZA
LENGTH 
L10 (1000mm)
L20 (2000mm)

Profilo+Diffusore+Tappi (1 chiuso e 1 aperto)
Profile+Diffuser+Caps (1 closed and 1 open)

Incasso a raso
Flush recessed

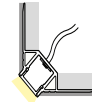

Scheda tecnica
Datasheet



Configuratore di riferimento:
Reference configurator:

Es: 2351-002L20

CODICI COMPONENTI SINGOLI: SINGLE COMPONENTS CODES:

PROFILO
PROFILE 
COD. BASE
BASE CODE
14626-

L=
L10
L20

DIFFUSORE
DIFFUSER 
COD. BASE
BASE CODE
14633-
opale/opal

L=
L10
L20

TAPPI
CAPS 
COD. BASE
BASE CODE
14631/14632
chiuso / passacavo
close/grommet

OPZIONALE OPTIONAL



SERVIZIO DI TAGLIO SU MISURA:

Per informazioni più dettagliate
sul servizio di taglio vedi pag. 230

CUSTOM CUT SERVICE:

For more detailed information
on the cutting service see page 230

PROFILO 2646

Incasso a raso
Flush recessed



Scheda tecnica
Datasheet

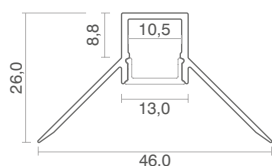

misure in mm / measurements in mm

Alluminio anodizzato
Anodized aluminum

LUNGHEZZA MASSIMA: 2m
MAXIMUM LENGTH: 2m

CE IP20

COMPOSIZIONE CODICE KIT
KIT CODE COMPOSITION

Profilo+Diffusore+Tappi (1 chiuso e 1 aperto)
Profile+Diffuser+Caps (1 closed and 1 open)

COD.BASE **DIFFUSORE**
BASE CODE: DIFFUSER
2646- **0** (opale/opal)

FINITURA
FINISH
00 (alluminio/aluminium)

LUNGHEZZA
LENGTH
L10 (1000mm)
L20 (2000mm)

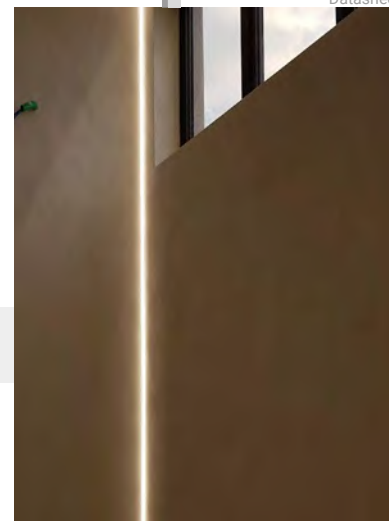

Configuratore di riferimento:
Reference configurator:
Es: 2646-000L10

CODICI COMPONENTI SINGOLI:
SINGLE COMPONENTS CODES:

PROFILO
PROFILE
COD. BASE
BASE CODE
14630-

L=
L10
L20

DIFFUSORE
DIFFUSER
COD. BASE
BASE CODE
14633-
opale/opal

L=
L10
L20

TAPPI
CAPS
COD. BASE
BASE CODE
14631/14632
Passacavo/chiuso
Grommet/closed

OPZIONALE
OPTIONAL



SERVIZIO DI TAGLIO SU MISURA:

Per informazioni più dettagliate
sul servizio di taglio vedi pag. 230

CUSTOM CUT SERVICE:

For more detailed information
on the cutting service see page 230

PROFILO 3630

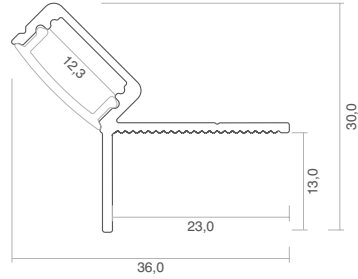

misure in mm / measurements in mm

Incasso a raso
Flush recessed

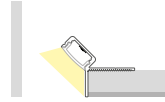

Scheda tecnica
Datasheet

Alluminio anodizzato
Anodized aluminum

Bianco
White

Nero
Black

LUNGHEZZA MASSIMA: 2m
MAXIMUM LENGTH: 2m

CE IP20

COMPOSIZIONE CODICE KIT KIT CODE COMPOSITION

Profilo+Diffusore+Tappi (1 chiuso e 1 aperto)
Profile+Diffuser+Caps (1 closed and 1 open)

COD.BASE
BASE CODE:
3630-

DIFFUSORE
DIFFUSER 
0 (opale/opal)

FINITURA
FINISH 
00 (alluminio/aluminium)
01 (bianco/white)
02 (nero/black)

LUNGHEZZA
LENGTH 
L10 (1000mm)
L20 (2000mm)

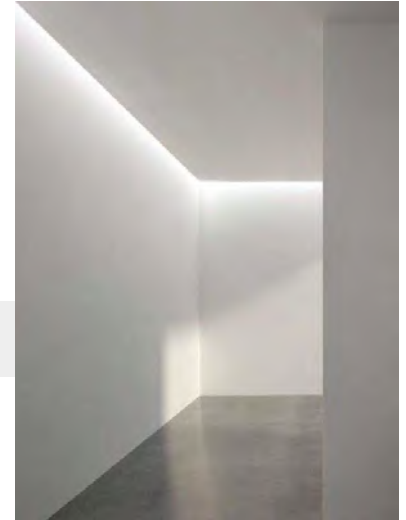

Configuratore di riferimento:
Reference configurator:
Es: 3630-000L20

CODICI COMPONENTI SINGOLI: SINGLE COMPONENTS CODES:

PROFILO
PROFILE 
COD. BASE
BASE CODE
12016-

FINITURE
FINISH 
L=

01
02

L10
L20

DIFFUSORE
DIFFUSER 
COD. BASE
BASE CODE
12017-
opale/opal

L=

L10
L20

TAPPI
CAPS 
COD. BASE
BASE CODE
12018-/12019-
Passacavo/chiuso
Grommet/closed

FINITURE
FINISH 
01
02

Senza il codice della finitura il
profilo si intende in alluminio
Without the finish code the
profile is made of aluminium

Senza il codice della finitura i
tappi si intendono in alluminio
Without the finish code i
caps are made of aluminium

OPZIONALE OPTIONAL



SERVIZIO DI TAGLIO SU MISURA:

Per informazioni più dettagliate
sul servizio di taglio vedi pag. 230

CUSTOM CUT SERVICE:

For more detailed information
on the cutting service see page 230

PROFILO 6137 - Luce recessa

Deeply recessed

Incasso a raso
Flush recessed



Scheda tecnica
Datasheet

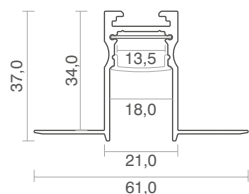
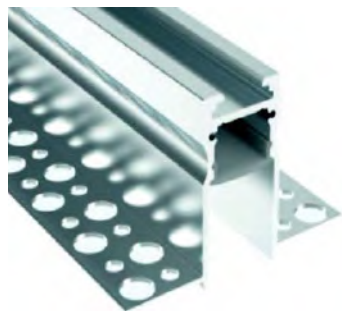

UGR<19

misure in mm / measurements in mm

Alluminio anodizzato
Anodized aluminum

LUNGHEZZA MASSIMA: 2m
MAXIMUM LENGTH: 2m

CE IP20

COMPOSIZIONE CODICE KIT
KIT CODE COMPOSITION

Profilo+Diffusore+Tappi (1 chiuso e 1 aperto)
Profile+Diffuser+Caps (1 closed and 1 open)

COD. BASE
BASE CODE: **6137-**

DIFFUSORE
DIFFUSER: **0** (opale/opal)

FINITURA
FINISH: **00** (alluminio/aluminium)

LUNGHEZZA
LENGTH: **L10** (1000mm)
L20 (2000mm)

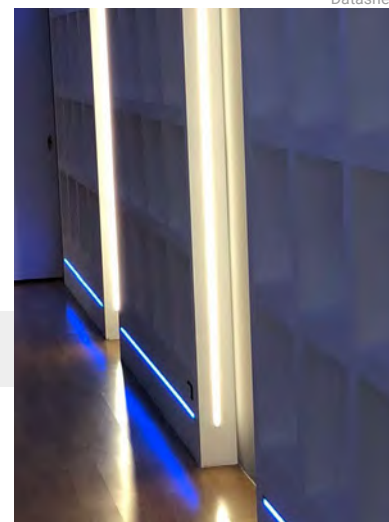

Configuratore di riferimento:
Reference configurator:
Es: 6137-000L20

CODICI COMPONENTI SINGOLI:
SINGLE COMPONENTS CODES:

PROFILO
PROFILE

COD. BASE
BASE CODE: **14807-**

L= **L10**
L20

DIFFUSORE
DIFFUSER

COD. BASE
BASE CODE: **14804-**
opale/opal

L= **L10**
L20

TAPPI
CAPS

COD. BASE
BASE CODE: **14811 / 14810**
passacavo/chiuso
grommet/closed

OPZIONALE
OPTIONAL



SERVIZIO DI TAGLIO SU MISURA:

Per informazioni più dettagliate
sul servizio di taglio vedi pag. 230

CUSTOM CUT SERVICE:

For more detailed information
on the cutting service see page 230

PROFILO 3596

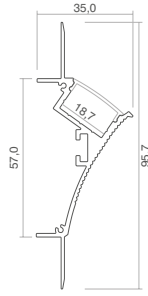

misure in mm / measurements in mm

Alluminio anodizzato
 Anodized aluminum
 Bianco
 White
 Nero
 Black

LUNGHEZZA MASSIMA: 2m
 MAXIMUM LENGTH: 2m

CE IP20

Incasso a raso
 Flush recessed



Scheda tecnica
 Datasheet



COMPOSIZIONE CODICE KIT KIT CODE COMPOSITION

Profilo+Diffusore+Tappi (1 chiuso e 1 aperto)
 Profile+Diffuser+Caps (1 closed and 1 open)

COD.BASE
 BASE CODE:
3596-

DIFFUSORE
 DIFFUSER

0 (opale/opal)

FINITURA
 FINISH

00 (alluminio/aluminium)
01 (bianco/white)
02 (nero/black)

LUNGHEZZA
 LENGTH

L10 (1000mm)
L20 (2000mm)

Configuratore di riferimento:
 Reference configurator:
Es: 3596-000L20

CODICI COMPONENTI SINGOLI: SINGLE COMPONENTS CODES:

PROFILO
 PROFILE

COD. BASE
 BASE CODE

14757-

FINITURE
 FINISH

L=

01
02

L10
L20

DIFFUSORE
 DIFFUSER

COD. BASE
 BASE CODE

14766-
 opale/opal

L=

L10
L20

TAPPI
 CAPS

COD. BASE
 BASE CODE

14759-/14758-
 Passacavo/chiuso
 Grommet/closed

FINITURE
 FINISH

01
02

Senza il codice della finitura il
 profilo si intende in alluminio
 Without the finish code the
 profile is made of aluminium

Senza il codice della finitura i
 tappi si intendono in alluminio
 Without the finish code i
 caps are made of aluminium

OPZIONALE OPTIONAL



SERVIZIO DI TAGLIO SU MISURA:

Per informazioni più dettagliate
 sul servizio di taglio vedi pag. 230

CUSTOM CUT SERVICE:

For more detailed information
 on the cutting service see page 230

PROFILO 9536

Incasso a raso
Flush recessed

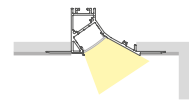

Scheda tecnica
Datasheet

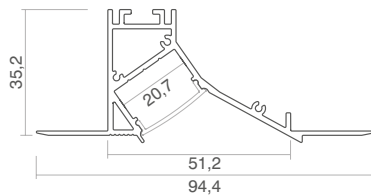
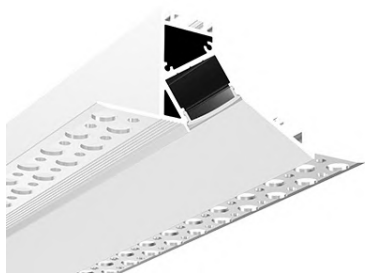

misure in mm / measurements in mm

Bianco
White Nero
Black

LUNGHEZZA MASSIMA: 2m
MAXIMUM LENGTH: 2m

CE IP20

COMPOSIZIONE CODICE KIT
KIT CODE COMPOSITION

Profilo+Diffusore+Tappi (1 chiuso e 1 aperto)
Profile+Diffuser+Caps (1 closed and 1 open)

COD. BASE **DIFFUSORE**
BASE CODE: DIFFUSER
9536- **0** (opale/opal)

FINITURA
FINISH
01 (bianco/white)
02 (nero/black)

LUNGHEZZA
LENGTH
L10 (1000mm)
L20 (2000mm)

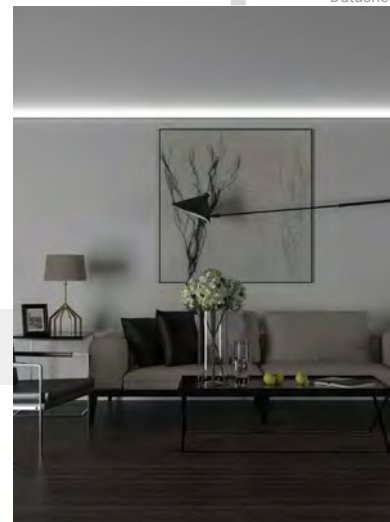

Configuratore di riferimento:
Reference configurator:
Es: 9536-001L20

CODICI COMPONENTI SINGOLI:
SINGLE COMPONENTS CODES:

PROFILO
PROFILE
COD. BASE **FINITURE** **L=**
BASE CODE FINISH
14754- **01** **L10**
02 **L20**

DIFFUSORE
DIFFUSER
COD. BASE **L=**
BASE CODE
14698- **L10**
opale/opal **L20**

TAPPI
CAPS
COD. BASE **FINITURE**
BASE CODE FINISH
14756- / 14755- **01**
passacavo/chiuso **02**
grommet/closed

OPZIONALE
OPTIONAL



SERVIZIO DI TAGLIO SU MISURA:

Per informazioni più dettagliate
sul servizio di taglio vedi pag. 230

CUSTOM CUT SERVICE:

For more detailed information
on the cutting service see page 230

PROFILO 4216

Incasso a raso
Flush recessed



Scheda tecnica
Datasheet

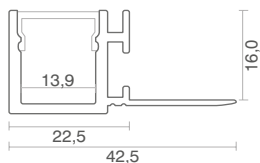

misure in mm / measurements in mm

Alluminio anodizzato
Anodized aluminum

Bianco
White

Nero
Black

LUNGHEZZA MASSIMA: 2m
MAXIMUM LENGTH: 2m

CE IP20

COMPOSIZIONE CODICE KIT

KIT CODE COMPOSITION

Profilo+Diffusore+Tappi (1 chiuso e 1 aperto)
Profile+Diffuser+Caps (1 closed and 1 open)

COD. BASE
BASE CODE:
4216-

DIFFUSORE
DIFFUSER 
0 (opale/opal)

FINITURA
FINISH 
00 (alluminio/aluminium)
01 (bianco/white)
02 (nero/black)

LUNGHEZZA
LENGTH 
L10 (1000mm)
L20 (2000mm)





Configuratore di riferimento:
Reference configurator:
Es: 4216-000L20

CODICI COMPONENTI SINGOLI:

SINGLE COMPONENTS CODES:

PROFILO
PROFILE 
COD. BASE
BASE CODE
14890-

FINITURE
FINISH 
01
02

L=

L10
L20

DIFFUSORE
DIFFUSER 
COD. BASE
BASE CODE
14891-
opale/opal

L=

L10
L20

TAPPI
CAPS 
COD. BASE
BASE CODE
14892P- / 14892C-
passacavo/chiuso
grommet/closed

FINITURE
FINISH 
01
02

Senza il codice della finitura il
profilo si intende in alluminio
Without the finish code the
profile is made of aluminium

Senza il codice della finitura i
tappi si intendono in alluminio
Without the finish code i
caps are made of aluminium

OPZIONALE

OPTIONAL



SERVIZIO DI TAGLIO SU MISURA:

Per informazioni più dettagliate
sul servizio di taglio vedi pag. 230

CUSTOM CUT SERVICE:

For more detailed information
on the cutting service see page 230

PROFILO 4219

Incasso a raso
Flush recessed



Scheda tecnica
Datasheet

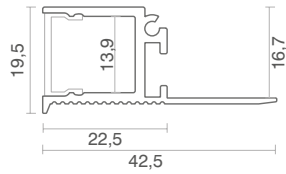

misure in mm / measurements in mm

Alluminio anodizzato
Anodized aluminum

Bianco
White

Nero
Black

LUNGHEZZA MASSIMA: 2m
MAXIMUM LENGTH: 2m

CE IP20

COMPOSIZIONE CODICE KIT KIT CODE COMPOSITION

Profilo+Diffusore+Tappi (1 chiuso e 1 aperto)
Profile+Diffuser+Caps (1 closed and 1 open)

COD.BASE
BASE CODE:

4219-

DIFFUSORE
DIFFUSER

0 (opale/opal)

FINITURA
FINISH

00 (alluminio/aluminium)
01 (bianco/white)
02 (nero/black)

LUNGHEZZA
LENGTH

L10 (1000mm)
L20 (2000mm)



Configuratore di riferimento:
Reference configurator:
Es: 4219-001L20

CODICI COMPONENTI SINGOLI: SINGLE COMPONENTS CODES:

PROFILO
PROFILE

COD. BASE
BASE CODE

14887

FINITURA
FINISH

01
02

L=

L10
L20

DIFFUSORE
DIFFUSER

COD. BASE
BASE CODE

14891-
opale/opal

L=

L10
L20

TAPPI
CAPS

COD. BASE
BASE CODE

14889P- / 14889C-
Passacavo/chiuso
Grommet/closed

FINITURA
FINISH

01
02

Senza il codice della finitura il
profilo si intende in alluminio
Without the finish code the
profile is made of aluminium

Senza il codice della finitura i
tappi si intendono in alluminio
Without the finish code i
caps are made of aluminium

OPZIONALE
OPTIONAL



SERVIZIO DI TAGLIO SU MISURA:

Per informazioni più dettagliate
sul servizio di taglio vedi pag. 230

CUSTOM CUT SERVICE:

For more detailed information
on the cutting service see page 230

PROFILO 7454

Incasso a raso
Flush recessed



Scheda tecnica
Datasheet

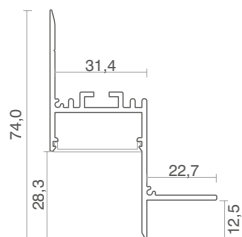
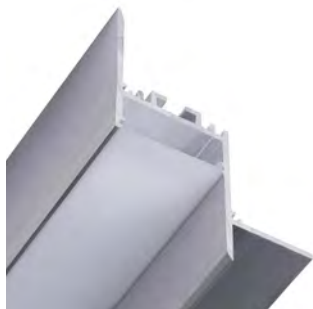

misure in mm / measurements in mm

Alluminio anodizzato
Anodized aluminum Bianco
White

LUNGHEZZA MASSIMA: 4m
MAXIMUM LENGTH: 4m

CE IP20

COMPOSIZIONE CODICE KIT
KIT CODE COMPOSITION

Profilo+Diffusore+Tappi (1 chiuso e 1 aperto)
Profile+Diffuser+Caps (1 closed and 1 open)

COD.BASE
BASE CODE:
7454-

DIFFUSORE
DIFFUSER 
0 (opale/opal)

FINITURA
FINISH 
00 (alluminio/aluminium)
01 (bianco/white)

LUNGHEZZA
LENGTH 
L10 (1000mm)
L20 (2000mm)
L30 (3000mm)
L40 (4000mm)



Configuratore di riferimento:
Reference configurator:
Es: 7454-001L40

CODICI COMPONENTI SINGOLI:
SINGLE COMPONENTS CODES:

PROFILO
PROFILE 
COD. BASE
BASE CODE
14921-

FINITURE
FINISH  L=
01

L10
L20
L30
L40

DIFFUSORE
DIFFUSER 
COD. BASE
BASE CODE
14774-
opale/opal

L10
L20
L30
L40

**Senza il codice della finitura il
profilo si intende in alluminio**
Without the finish code the
profile is made of aluminium

OPZIONALE
OPTIONAL



SERVIZIO DI TAGLIO SU MISURA:

Per informazioni più dettagliate
sul servizio di taglio vedi pag. 230

CUSTOM CUT SERVICE:

For more detailed information
on the cutting service see page 230

PROFILO 13664

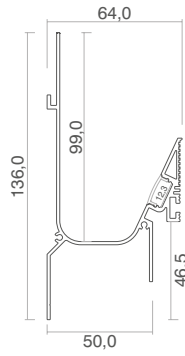
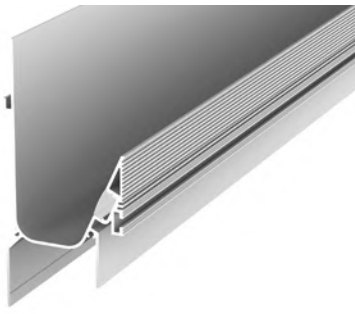

misure in mm / measurements in mm

Incasso a raso
Flush recessed

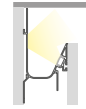

Scheda tecnica
Datasheet

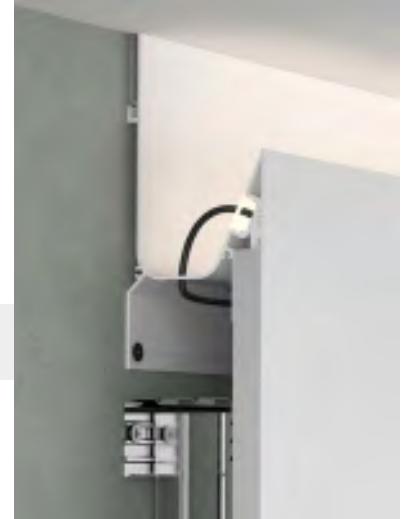

Configuratore di riferimento:
Reference configurator:
Es: 13664-001L20

Alluminio anodizzato
Anodized aluminum

Bianco
White

Nero
Black

LUNGHEZZA MASSIMA: 2m
MAXIMUM LENGTH: 2m

CE IP20

COMPOSIZIONE CODICE KIT
KIT CODE COMPOSITION

Profilo+Diffusore+Tappi (1 chiuso e 1 aperto)+Staffa
Profile+Diffuser+Caps (1 closed and 1 open)+Bracket

COD. BASE
BASE CODE:

DIFFUSORE
DIFFUSER



13664- **0** (opale/opal)

FINITURA
FINISH



00 (alluminio/aluminium)
01 (bianco/white)
02 (nero/black)

LUNGHEZZA
LENGTH

L10 (1000mm)
L20 (2000mm)

CODICI COMPONENTI SINGOLI:
SINGLE COMPONENTS CODES:

PROFILO
PROFILE



COD. BASE
BASE CODE
12020

FINITURA
FINISH

01
02

L=
L10
L20

DIFFUSORE
DIFFUSER

COD. BASE
BASE CODE
12021-
opale/opal

L=
L10
L20

TAPPI
CAPS

COD. BASE
BASE CODE

12022- / 12023-
Passacavo/chiuso
Grommet/closed



FINITURA
FINISH

01
02

FISSAGGIO
FIXING

COD. BASE
BASE CODE

12024
Staffa
33,6x25x4,2mm
Bracket
33,6x25x4,2mm

Senza il codice della finitura il profilo si intende in alluminio
Without the finish code the profile is made of aluminium

Senza il codice della finitura i tappi si intendono in alluminio
Without the finish code i caps are made of aluminium

OPZIONALE
OPTIONAL



SERVIZIO DI TAGLIO SU MISURA:

Per informazioni più dettagliate sul servizio di taglio vedi pag. 230

CUSTOM CUT SERVICE:

For more detailed information on the cutting service see page 230

XPS, PU, EPS

Le cornici per controsoffitti in XPS (polistirene estruso), anche conosciuto come polistirene espanso estruso o schiuma rigida di polistirene, sono elementi decorativi utilizzati per aggiungere dettagli e stile ai soffitti sospesi o controsoffitti. L'XPS è un materiale leggero e resistente che viene spesso utilizzato per la fabbricazione di cornici e modanature grazie alle sue caratteristiche di isolamento termico e acustico.

XPS (Extruded Polystyrene), also known as extruded expanded polystyrene or rigid polystyrene foam, is used to create decorative elements known as cornices for suspended or drop ceilings. These cornices are decorative elements used to add detail and style to suspended or drop ceilings. XPS is a lightweight and durable material often used for manufacturing cornices and moldings due to its thermal and acoustic insulation properties.



Per soluzioni architettoniche particolari

For particular architectural solutions

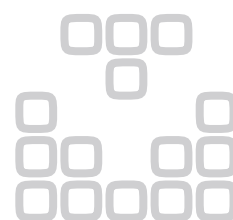

Queste cornici sono disponibili in diverse forme e design per adattarsi a vari stili di interni. Sono comunemente utilizzate per migliorare l'aspetto di spazi commerciali, residenziali e persino in set cinematografici o teatrali per creare effetti visivi interessanti. Le cornici per controsoffitti in XPS, PU e EPS sono facili da installare e possono essere tagliate o modellate per adattarsi alle dimensioni specifiche del soffitto, permettendo di creare degli appositi alloggi per fonti luminose a LED.

These cornices are available in various shapes and designs to fit different interior styles. They are commonly used to enhance the appearance of commercial and residential spaces, as well as on film or theater sets to create interesting visual effects. XPS, PU and EPS ceiling frame moldings are easy to install and can be cut or shaped to fit the specific dimensions of the ceiling, allowing for the creation of custom LED lighting solutions.



Le principali caratteristiche dei profili in XPS, PU e EPS includono:

- **Leggerezza** - Il materiale è leggero, il che semplifica il processo di installazione.
- **Resistenza e durata** - Resistente agli agenti atmosferici e all'umidità, quindi possono mantenere la loro forma e aspetto a lungo nel tempo.
- **Facilità di lavorazione** - I profili di questa famiglia possono essere tagliati, modellati e decorati facilmente per adattarsi a varie esigenze di progettazione.
- **Isolamento termico e acustico** - L'XPS offre anche un certo livello di isolamento termico e acustico, contribuendo a rendere gli ambienti più confortevoli.
- **Possibilità di finiture** - I profili possono essere dipinti con vernici a base d'acqua per abbinarle allo stile e all'arredamento dell'ambiente circostante.
- **Manutenzione ridotta** - Richiedono una manutenzione minima, poiché il materiale è resistente alle muffe e agli insetti.

The main characteristics of the XPS, PU and EPS profiles include:

- **Lightweight** - The material is lightweight, which simplifies the installation process.
- **Strength and durability** - Resistant to atmospheric agents and humidity, so they can maintain their shape and appearance for a long time.
- **Easy to work with** - Profiles in this family can be easily cut, shaped and decorated to suit various design needs.
- **Thermal and acoustic insulation** - XPS also provides a certain level of thermal and acoustic insulation, contributing to a more comfortable environment.
- **Finishing options** - The profiles can be painted with water-based paints to match the style and decor of the surrounding environment.
- **Low maintenance** - They require minimal maintenance, as the material is resistant to mold and insects.

PROFILO 16560 - XPS

Incasso a cartongesso
Recessed in plasterboard



Scheda tecnica
Datasheet

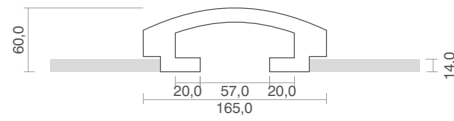

Taglio di luce indiretta a soffitto in cartongesso

Indirect light cutting in
plasterboard ceiling

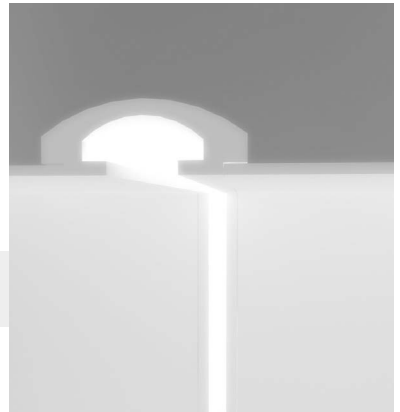

misure in mm / measurements in mm

LUNGHEZZA: 1150mm
LENGTH: 1150mm

COD.BASE
BASE CODE:

P16560 Materiale XPS. Rivestimento in **resina acrilica**. Larghezza massima vano LED 20mm (2 stripLED).
XPS material. **Acrylic resin** coating. Maximum LED compartment width 20mm (2 stripLED).

* Venduto senza profilo di contenimento StripLED.
* Sold without StripLED containment profile.

PROFILI CONSIGLIATI:
RECOMMENDED PROFILE:

1510

1616

PAGINA:
PAGE:

149

177

PROFILO 15558 - XPS

Incasso a cartongesso
Recessed in plasterboard



Scheda tecnica
Datasheet

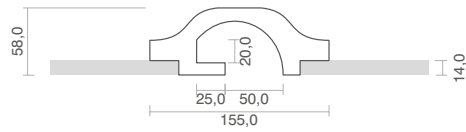

Taglio di luce indiretta a soffitto in cartongesso

Indirect light cutting in
plasterboard ceiling



misure in mm / measurements in mm

LUNGHEZZA: 1150mm
LENGTH: 1150mm

COD.BASE
BASE CODE:

P15558

Materiale XPS. Rivestimento in **resina acrilica**. Larghezza massima vano LED 20mm (1 stripLED).
XPS material. **Acrylic resin** coating. Maximum LED compartment width 20mm (1 stripLED).

* Venduto senza profilo di contenimento StripLED.
* Sold without StripLED containment profile.

PROFILI CONSIGLIATI:
RECOMMENDED PROFILE:

1510

1616

PAGINA:
PAGE:

149

177

PROFILO 13090 - XPS

Incasso a cartongesso
Recessed in plasterboard



Scheda tecnica
Datasheet

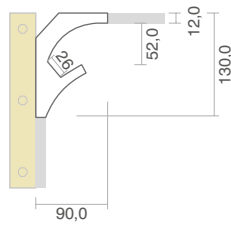

misure in mm / measurements in mm

LUNGHEZZA: 1150mm
LENGTH: 1150mm

**Veletta stondata
per luce diffusa ad
angolo**
Rounded canopy for
corner diffused light



COD.BASE
BASE CODE:

P13090

Materiale XPS. Rivestimento in **resina acrilica**. Larghezza massima vano LED 25mm (1 stripLED).
XPS material. **Acrylic resin** coating. Maximum LED compartment width 25mm (2 stripLED).

* Venduto senza profilo di contenimento StripLED.
* Sold without StripLED containment profile.

PROFILI CONSIGLIATI:
RECOMMENDED PROFILE:

1510

1616

PAGINA:
PAGE:

149

177

PROFILO 10060 - XPS

Incasso cartongesso/Muratura
Recessed in plasterboard/walling



Scheda tecnica
Datasheet

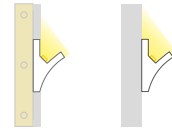
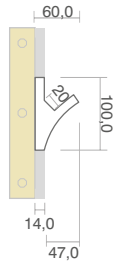
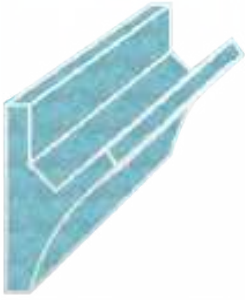

**Veletta da incasso
a parete con luce
diffusa**

Recessed wall veil with
diffused light

misure in mm / measurements in mm



LUNGHEZZA: 1150mm
LENGTH: 1150mm

COD.BASE
BASE CODE:

P10060

Materiale XPS. Rivestimento in **resina acrilica**. Larghezza massima vano LED 20mm (1 stripLED).
XPS material. **Acrylic resin** coating. Maximum LED compartment width 20mm (1 strips).

* Venduto senza profilo di contenimento StripLED.
* Sold without StripLED containment profile.

PROFILI CONSIGLIATI:
RECOMMENDED PROFILE:

1510

PAGINA:
PAGE:

149

PROFILO 95095 - XPS

Incasso a cartongesso
Recessed in plasterboard



Scheda tecnica
Datasheet

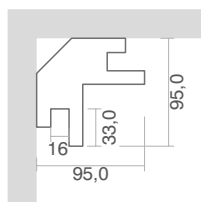

**Profilo angolare
tra soffitto e parete
(biemissione)**
Angular profile between
ceiling and wall
(biemissione)

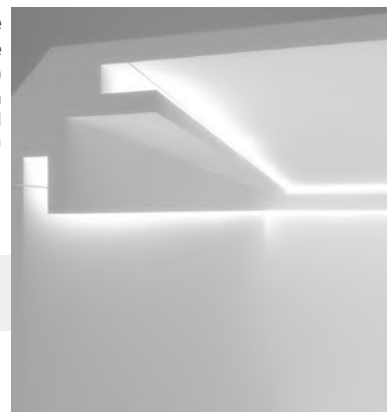
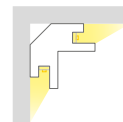

misure in mm / measurements in mm

LUNGHEZZA: 1150mm
LENGTH: 1150mm

COD.BASE
BASE CODE:

P95095 Materiale XPS. Rivestimento in **resina acrilica**. Larghezza massima vano LED 16mm (2 stripLED).
XPS material. **Acrylic resin** coating. Maximum LED compartment width 16mm (2 stripLED).

* Venduto senza profilo di contenimento StripLED.
* Sold without StripLED containment profile.

PROFILI CONSIGLIATI:
RECOMMENDED PROFILE:

1510

PAGINA:
PAGE:

149

PROFILO 12040 - XPS

Incasso a cartongesso
Recessed in plasterboard



Scheda tecnica
Datasheet

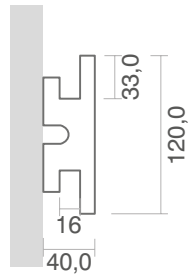

**Cornice veletta con
luce diffusa a parete
(biemissione)**

Curtain frame with wall
diffused light
(biemission)

misure in mm / measurements in mm

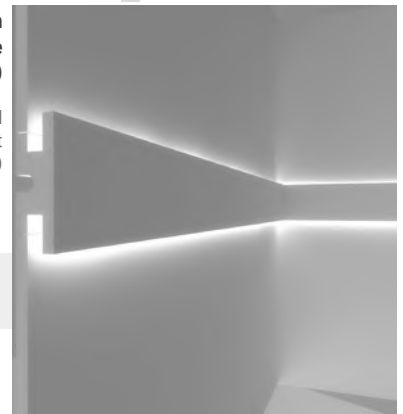

LUNGHEZZA: 1150mm
LENGTH: 1150mm

COD.BASE
BASE CODE:

P12040

Materiale XPS. Rivestimento in **resina acrilica**. Larghezza massima vano LED 16mm (2 stripLED).
XPS material. **Acrylic resin** coating. Maximum LED compartment width 16mm (2 stripLED).

* Venduto senza profilo di contenimento StripLED.

* Sold without StripLED containment profile.

PROFILI CONSIGLIATI:
RECOMMENDED PROFILE:

1510

PAGINA:
PAGE:

149

PROFILO 75036 - PU

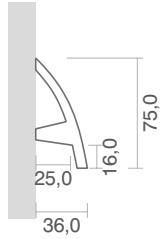

Incasso a cartongesso
Recessed in plasterboard

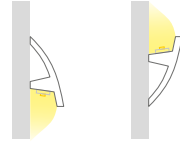

Scheda tecnica
Datasheet

Cornice stondata per luce diffusa a parete

Rounded frame for
diffused light on
the wall

misure in mm / measurements in mm



LUNGHEZZA: 2000mm
LENGTH: 2000mm

COD.BASE
BASE CODE:

P75036

Materiale PU. Rivestimento in **resina acrilica**. Larghezza massima vano LED 20mm (1 stripLED).
PU material. **Acrylic resin** coating. Maximum LED compartment width 20mm (1 stripLED).

* Venduto senza profilo di contenimento StripLED.
* Sold without StripLED containment profile.

PROFILI CONSIGLIATI:
RECOMMENDED PROFILE:

1510

PAGINA:
PAGE:

149

PROFILO 11515 - PU

Incasso a cartongesso
Recessed in plasterboard



Scheda tecnica
Datasheet

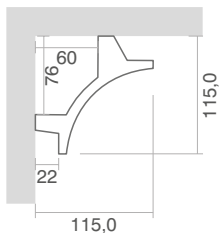
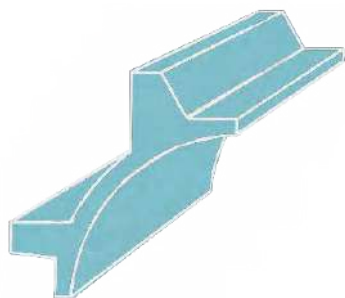

Cornice con doppio taglio di luce angolare

Frame with double angular light cut

misure in mm / measurements in mm



LUNGHEZZA: 2000mm
LENGTH: 2000mm

COD.BASE
BASE CODE:

P11515 Materiale PU. Rivestimento in **resina acrilica**. Larghezza massima vano LED 18mm (2 stripLED).
XPS material. **Acrylic resin** coating. Maximum LED compartment width 18mm (2 stripLED).

* Venduto senza profilo di contenimento StripLED.
* Sold without StripLED containment profile.

PROFILI CONSIGLIATI:
RECOMMENDED PROFILE:

1510

PAGINA:
PAGE:

149

PROFILO 25014 - EPS

Incasso a cartongesso
Recessed in plasterboard



Scheda tecnica
Datasheet

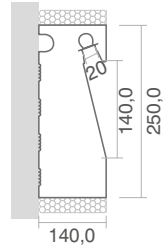
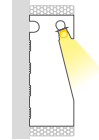

Segnapasso lineare ad incasso nel cappotto termico

Built-in linear marker
in the
thermal coat

misure in mm / measurements in mm

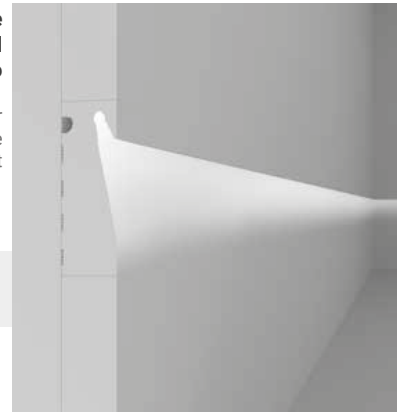

LUNGHEZZA: 1000mm
LENGTH: 1000mm

COD.BASE
BASE CODE:

P25014 Materiale EPS. Rivestimento in **resina acrilica**. StripLED direzionata verso il basso (1 stripLED IP65). **Cappotto termico.**
EPS material. **Acrylic resin** coating. StripLED directed downwards (1 strips IP65). **Thermal coat.**

* Venduto senza profilo di contenimento StripLED.
* Sold without StripLED containment profile.

PROFILO 28055 - EPS

Incasso a cartongesso
Recessed in plasterboard



Scheda tecnica
Datasheet

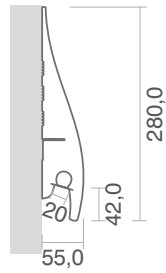

Cornice stondata per cascata di luce a parete

Rounded frame for wall
light cascade

misure in mm / measurements in mm

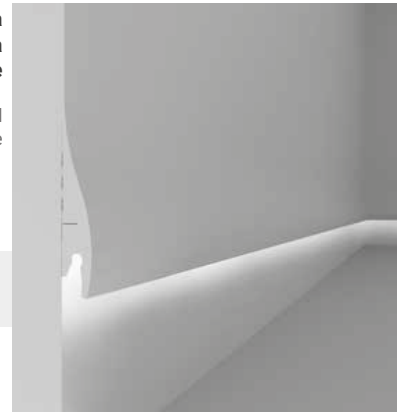

LUNGHEZZA: 1000mm
LENGTH: 1000mm

COD.BASE
BASE CODE:

P28055

Materiale EPS. Rivestimento in **resina acrilica**. StripLED direzionata verso il basso (1 stripLED IP65).
EPS material. **Acrylic resin** coating. StripLED directed downwards (1 strips IP65).

* Venduto senza profilo di contenimento StripLED.

* Sold without StripLED containment profile.

PROFILO 27055 - EPS

Incasso a cartongesso
Recessed in plasterboard



Scheda tecnica
Datasheet

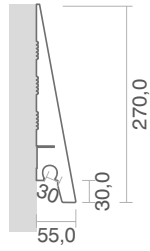
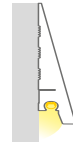

Cornice squadrata per cascata di luce a parete

Square frame for wall
light cascade

misure in mm / measurements in mm

LUNGHEZZA: 1000mm
LENGTH: 1000mm



COD.BASE
BASE CODE:

P27055

Materiale EPS. Rivestimento in **resina acrilica**. StripLED direzionata verso il basso (1 stripLED IP65).
EPS material. **Acrylic resin** coating. StripLED directed downwards (1 strips IP65).

* Venduto senza profilo di contenimento StripLED.

* Sold without StripLED containment profile.

PROFILO 15030 - EPS

Incasso a cartongesso
Recessed in plasterboard



Scheda tecnica
Datasheet

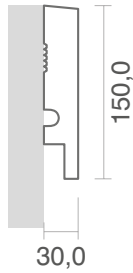

Marcapiano modulare con taglio di luce

Modular belt course with light cutting

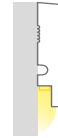

misure in mm / measurements in mm

LUNGHEZZA: 1000mm
LENGTH: 1000mm

COD.BASE
BASE CODE:

P15030 Materiale EPS. Rivestimento in **resina fibrata acrilica pitturabile**. (1 stripLED IP65)
Material EPS. **Acrylic fibrate resin coating can be painted**. (1 stripLED IP65)

* Venduto senza profilo di contenimento StripLED.
* Sold without StripLED containment profile.

PROFILO 25090 - EPS

Incasso a cartongesso
Recessed in plasterboard



Scheda tecnica
Datasheet

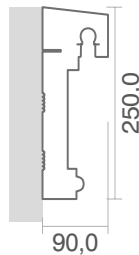

Marcapiano modulare con taglio di luce

Modular belt course with light cutting



misure in mm / measurements in mm

LUNGHEZZA: 1000mm
LENGTH: 1000mm

COD.BASE
BASE CODE:

P25090 Materiale EPS. Rivestimento in **resina fibrata acrilica pitturabile**. (1 stripLED IP65)
Material EPS. **Acrylic fibrate resin coating can be painted**. (1 stripLED IP65)

* Venduto senza profilo di contenimento StripLED.
* Sold without StripLED containment profile.

Servizio di taglio

Cutting service

Elcom offre un servizio di taglio dei profili per illuminazione in grado di accontentare tutte le richieste di installazione. Grazie al servizio di taglio a 45° orizzontale o verticale è infatti possibile ottenere giunzioni per realizzare cornici e angoli di 90°.

Elcom offers a profile cutting service for lighting that can satisfy all installation requests. Thanks to the horizontal or vertical 45° fold cutting service, it is possible to install joints to create frames and angles of 90°.

TAGLIO 45° PER GIUNZIONI VERTICALI CUTTING 45° FOR VERTICAL JOINTS

PER IL TAGLIO CONTATTA IL NOSTRO REPARTO TECNICO
FOR CUTTING CONTACT OUR TECHNICAL DEPARTMENT

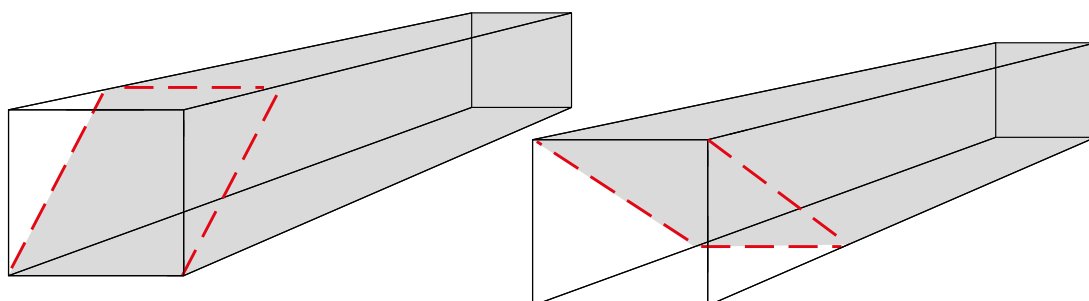
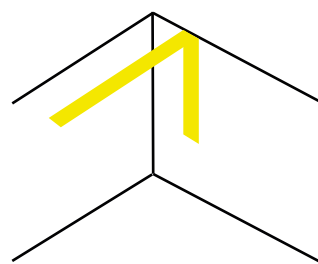

TAGLIO 45° PER GIUNZIONI ORIZZONTALI CUTTING 45° FOR HORIZONTAL JOINTS

PER IL TAGLIO CONTATTA IL NOSTRO REPARTO TECNICO
FOR CUTTING CONTACT OUR TECHNICAL DEPARTMENT

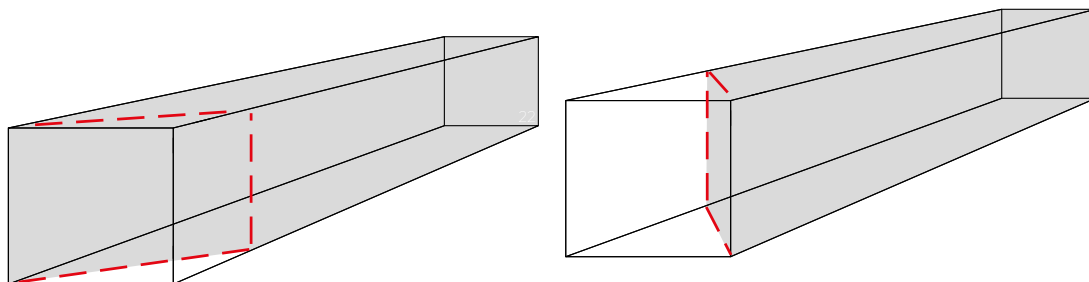
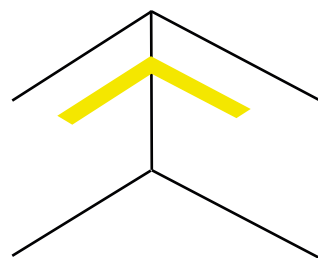

TAGLIO SU MISURA CUSTOM CUTTING

PER IL TAGLIO DI PROFILI SU MISURA DI LUNGHEZZE PERSONALIZZATE CONTATTA IL NOSTRO REPARTO COMMERCIALE
FOR CUTTING CUSTOM-MADE PROFILES OF CUSTOMIZED LENGTHS CONTACT OUR SALES DEPARTMENT

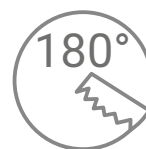
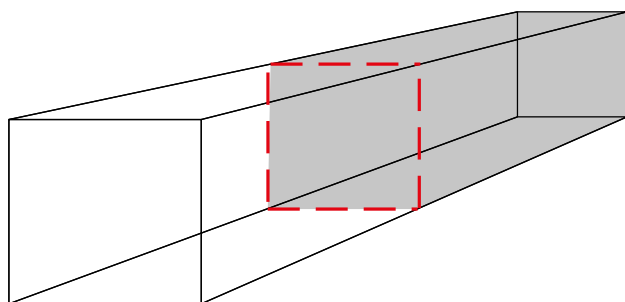

Personalizzazione al massimo livello

Customization at the highest level



I profili Elcom possono essere sezionati a misura a seconda dei progetti da realizzare, inoltre i tagli a 45° permettono di creare cornici sia in verticale che in orizzontale. Inoltre possiamo effettuare anche tagli per applicazioni specifiche a qualsiasi grado di angolazione.

Questa duttilità permette di creare progetti ad hoc per ogni ambiente, grazie all'esperienza dei nostri tecnici che sapranno consigliarti la soluzione di illuminazione migliore, adattando i nostri profili alla struttura nella quale vengono applicati.

Per richieste particolari con diverse angolazioni contatta i nostri uffici.

Elcom profiles can be sectioned to size depending on the projects to be realized, in addition, the 45-layer cuts allow you to create frames both vertically and horizontally. This flexibility allows you to create ad hoc projects for each environment, thanks to the experience of our technicians who will advise you on the best lighting solution, adapting our profiles to the structure in which they are applied.

For special requests with different angles contact our offices.



Profili da Esterno

Outdoor profiles

Questi profili di illuminazione si adattano con flessibilità a qualsiasi esigenza di progetto e comunicano in armonia con l'ambiente esterno, mettendo la luce al centro dell'attenzione e valorizzando materiali, architetture e la bellezza naturale circostante.

These lighting profiles adapt flexibly to any project requirement and harmoniously blend with the external environment, placing light at the center of attention and enhancing materials, architectures, and the surrounding natural beauty.



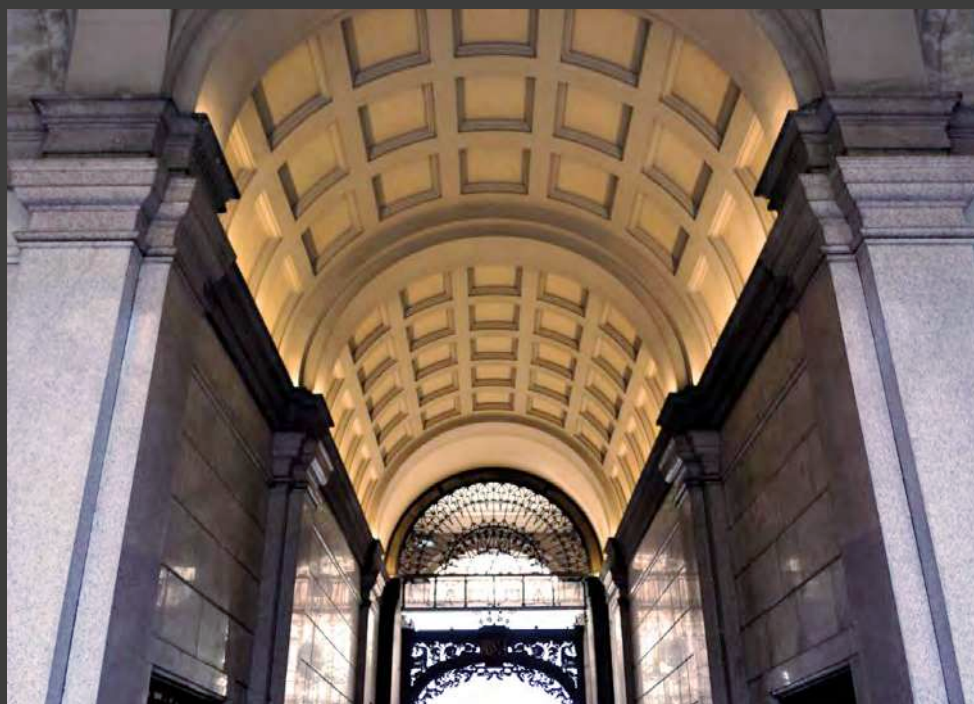

Profili con elevata protezione IP

Profiles with high IP protection



Questi profili danno vita a ambienti incantevoli con suggestivi giochi di luce, creando ombre e scenografie uniche, caratterizzando con personalità le facciate, il terrazzo o i percorsi. La versatilità di questi profili li rende in grado di abbinarsi perfettamente al design di qualsiasi spazio, arricchendolo di stile ed eleganza.

Che siano recessati, calpestabili o a applicazione superficiale, questi profili sono compatibili con la gamma di StripLED ad alta protezione IP65, garantendo un'illuminazione affidabile e resistente alle intemperie.

These profiles breathe life into enchanting spaces with captivating light effects, creating unique shadows and scenography, adding personality to facades, terraces, or pathways. The versatility of these profiles allows them to seamlessly integrate with the design of any space, enriching it with style and elegance.

Whether recessed, walkable, or surface-mounted, these profiles are compatible with the range of IP65-rated LED strips, ensuring reliable and weather-resistant illumination.

PROLINE 25 - con STRIPLED

Plafone
Ceiling-wall



Scheda tecnica
Datasheet

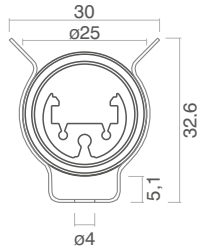
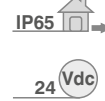

ALIMENTATORE NON INCLUSO
DRIVER NOT INCLUDED
misure in mm / measurements in mm



Configuratore di riferimento:
Reference configurator:
Es: 0025S-TLNL12

Alluminio
Aluminum

CE IP65

COMPOSIZIONE CODICE CODE COMPOSITION

COD.BASE BASE CODE:	TUBO TUBE	DIFFUSORE* DIFFUSER	COLORE LED LED COLOR	LUNGHEZZA LENGTH	DATI TECNICI TECHNICAL DATA	LUMEN SORGENTE SOURCE LUMENS	WATT
0025S-	*T (trasp./trasparent) O (opale/opal)	T (trasp./trasparent) O (opale/opal)	C (bianco caldo/warm white) N (bianco neutro/neutral white)	L06 (600mm) L12 (1200mm)	L06: C=1092 / N=1164 / F=1164 L12: C=2306 / N=2458 / F=2458		8 18
0025AV-		L (lentic./lenticular)	F (bianco freddo/cold white)	L18 (1800mm)	L18: C=3581 / N=3817 / F=3817		28
0025SR-			H (RGB)				

*Diffusore applicabile solo con tubo trasparente
*Diffuser applicable only with transparent tube

VARIANTI PRODOTTO PRODUCT VARIANTS

Per la variante proline 25 con tappi e fissaggio Antivandalo utilizzare il codice base "0025AV".
For the proline 25 variant with caps and vandal-proof fixing use the basic code "0025AV".

Per la variante proline 25 con tappi a spessore ridotto utilizzare il codice base "0025SR".
For the proline 25 variant with reduced thickness caps use the basic code "0025SR".

Configuratore di riferimento:
Reference configurator:

Es: 0025AV-TLNL12

Es: 0025SR-TLNL12

ACCESSORI ACCESSORIES

13045
Molletta in acciaio
Steel clip

Compatibile con Proline:
0025S e 0025SR
Compatible with Proline:
0025S and 0025SR

13000
Kit staffa antivandalo centrale
Central anti-vandal bracket kit

Compatibile con Proline:
0025AV
Compatible with Proline:
0025AV

12000
Sistema di fissaggio a sbalzo 200mm
(aggancio a tappo)
200mm cantilever fixing system
(cap hooking)

Compatibile con Proline:
0025AV
Compatible with Proline:
0025AV

12001
Sistema di fissaggio a sbalzo centrale 200mm
(aggancio su corpo lampada)
Central cantilever fixing system 200mm
(hook on the lamp body)

Compatibile con Proline:
0025AV
Compatible with Proline:
0025AV

OPZIONALE OPTIONAL

AL00305
DRIVER 24VDC 24W CLASSE II IP67 (per L=600mm/1200mm)

07605
DRIVER 24VDC 35W CLASSE II IP67 (per L=1800mm)

09000+AL00305
CONTROLLER RGB+RC 12~24V + DRIVER 24VDC 24W CLASSE II IP67 (per L=600mm) *

09000+07605
CONTROLLER RGB+RC 12~24V + DRIVER 24VDC 35W CLASSE II IP67 (per L=1200mm) *

09000+07606
CONTROLLER RGB+RC 12~24V + DRIVER 24VDC 60W CLASSE II IP67 (per L=1800mm) *

PROLINE 25 - con OTTICHE

Plafone
Ceiling-wall



Scheda tecnica
Datasheet

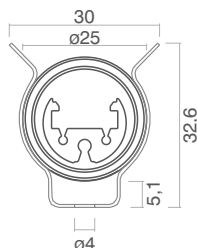

IP65

24 Vdc

TUBO TRASPARENTE
TRANSPARENT TUBE

ALIMENTATORE NON INCLUSO
DRIVER NOT INCLUDED

misure in mm / measurements in mm



Alluminio
Aluminum

CE IP65

COMPOSIZIONE CODICE CODE COMPOSITION

COD. BASE BASE CODE:	OTTICHE OPTICS	COLORE LED LED COLOR	LUNGHEZZA LENGTH	DATI TECNICI TECHNICAL DATA	WATT
0025S-	0 (15°)	C (bianco caldo/warm white)	L06 (600mm)	L06: C=780 / N=840 / F=870	8,4
	2 (25°)	N (bianco neutro/neutral white)	L12 (1200mm)	L12: C=1560 / N=1680 / F=1740	16,8
	4 (40°)	F (bianco freddo/cold white)	L18 (1800mm)	L18: C=2340 / N=2520 / F=2610	25,2
0025AV- 0025SR-	3 (18°x48°)				

Configuratore di riferimento:
Reference configurator:
Es: **0025S-2CL18**

VARIANTI PRODOTTO PRODUCT VARIANTS

Per la variante proline 25 con tappi e fissaggio Antivandalo utilizzare il codice base "0025AV".
For the proline 25 variant with caps and vandal-proof fixing use the basic code "0025AV".

Per la variante proline 25 con tappi a spessore ridotto utilizzare il codice base "0025SR".
For the proline 25 variant with reduced thickness caps use the basic code "0025SR".

Configuratore di riferimento:
Reference configurator:

Es: **0025AV-2CL18**

Es: **0025SR-2CL18**

ACCESSORI ACCESSORIES

13045
Molletta in acciaio
Steel clip

Compatibile con Proline:
0025S e 0025SR
Compatible with Proline:
0025S and 0025SR

13000
Kit staffa antivandalo centrale
Central anti-vandal bracket kit

Compatibile con Proline:
0025AV
Compatible with Proline:
0025AV

12000
Sistema di fissaggio a sbalzo 200mm
(aggancio a tappo)
200mm cantilever fixing system
(cap hooking)

Compatibile con Proline:
0025AV
Compatible with Proline:
0025AV

12001
Sistema di fissaggio a sbalzo centrale 200mm
(aggancio su corpo lampada)
Central cantilever fixing system 200mm
(hook on the lamp body)

Compatibile con Proline:
0025AV
Compatible with Proline:
0025AV

OPZIONALE OPTIONAL

AL00305
DRIVER 24VDC 24W CLASSE II IP67 (per L=600mm/1200mm)

07605
DRIVER 24VDC 35W CLASSE II IP67 (per L=1800mm)

09000+AL00305
CONTROLLER RGB+RC 12~24V + DRIVER 24VDC 24W CLASSE II IP67 (per L=600mm) *

09000+07605
CONTROLLER RGB+RC 12~24V + DRIVER 24VDC 35W CLASSE II IP67 (per L=1200mm) *

09000+07606
CONTROLLER RGB+RC 12~24V + DRIVER 24VDC 60W CLASSE II IP67 (per L=1800mm) *

PROLINE 7234

Incasso calpestabile
Walkable Recessed

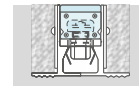

Scheda tecnica
Datasheet

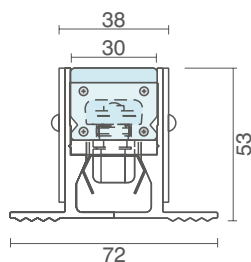

CASSAFORMA INCLUSA
FORMWORK INCLUDED
ALIMENTATORE NON INCLUSO
DRIVER NOT INCLUDED
misure in mm / measurements in mm

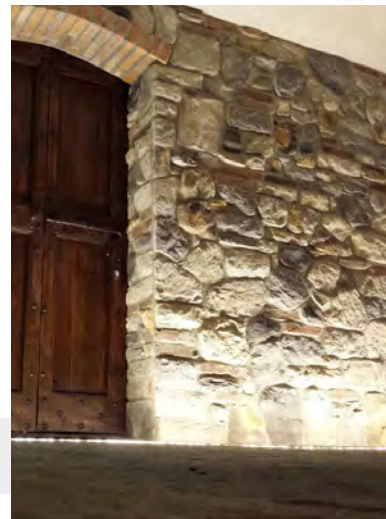

Alluminio + PMMA opale
Aluminum + opal PMMA

CE IP68

COMPOSIZIONE CODICE CODE COMPOSITION

COD.BASE BASE CODE:	COLORE LED LED COLOR	LUNGHEZZA LENGTH
7234PMMA-	C (bianco caldo/warm white)	L05 (500mm)
	N (bianco neutro/neutral white)	L10 (1000mm)
	F (bianco freddo/cold white)	L20 (2000mm)
	H (RGB)*	

DATI TECNICI TECHNICAL DATA

LUMEN	WATT	CRI
955	7,5	85
1910	15	85
3820	30	85

Configuratore di riferimento:
Reference configurator:
Es: 7234PMMA-CL20

*Nella versione RGB l'elettronica non è compresa (RGB = 18W/m)
*In the RGB version the electronics are not included (RGB = 18W/m)

ACCESSORI ACCESSORIES

10064-F
Mini connettore 2 poli IP68 femmina
IP68 female 2 pole mini connector

10064-M
Mini connettore 2 poli IP68 maschio
IP68 male 2 pole mini connector

OPZIONALE OPTIONAL

AL00305
DRIVER 24VDC 24W CLASSE II IP67 (per L=500mm e L=1000mm)

07606
DRIVER 24VDC 60W CLASSE II IP67 (per L=2000mm)

09000+AL00305
CONTROLLER RGB+RC 12~24V + DRIVER 24VDC 24W CLASSE II IP67 (per L=500mm) *

09000+07605
CONTROLLER RGB+RC 12~24V + DRIVER 24VDC 35W CLASSE II IP67 (per L=1000mm) *

09000+07606
CONTROLLER RGB+RC 12~24V + DRIVER 24VDC 60W CLASSE II IP67 (per L=2000mm) *

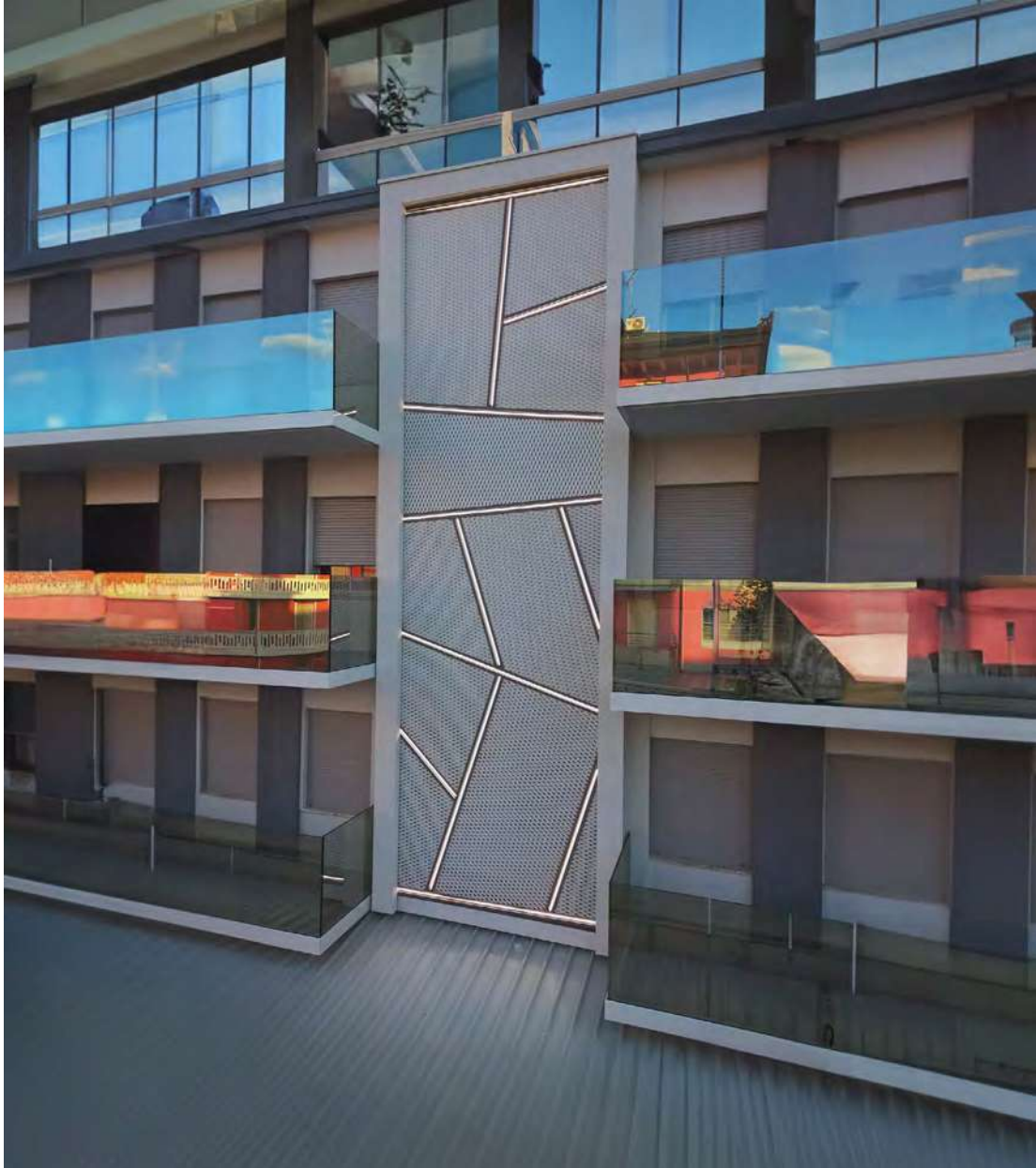



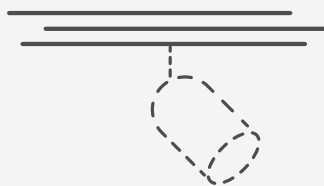

Binari elettrificati

electrified tracks

I binari sono progettati per essere facilmente installati a soffitto, a parete oppure incassati, per l'utilizzo di proiettori o apparecchi a sospensione. La semplicità di installazione degli apparecchi consente di avere impianti di illuminazione facilmente modificabili senza la necessità di interventi tecnici onerosi, così da creare scenari dinamici adattabili ai diversi ambienti.

Tracks are designed to be easily installed, either on or recessed into the ceiling or wall and for use with spotlights or with suspended fittings. This easy and quick installation allows modification of the lighting layout at any time, avoiding expensive works and providing a dynamic solution that can fit in many different spaces.

Linearità al servizio della creatività

Linearity at the service of creativity

La gamma di binari comprende binari dimmerabili, trifase, monofase e a bassa tensione, in grado di adattarsi in modo flessibile alle più svariate esigenze di illuminazione.

The track range includes dimmable, three-phase, single-phase and low voltage tracks, able to fit with different lighting demands in a flexible way.





Caratteristiche tecniche

I binari elettrificati sono costruiti in lega di alluminio estruso. I cavi conduttori in rame sono alloggiati all'interno di profilati estrusi in PVC ad alta resistenza di isolamento. Certificati dall'Istituto Italiano Marchio di Qualità (IMQ), sono conformi alle norme vigenti (EN 60570). I sistemi comprendono un'ampia varietà di accessori e di giunti di collegamento.

Technical Specifications

Electrified tracks are made of extruded aluminium alloy. The copper wires are located inside extruded PVC profiles with high insulating properties. They are certified by the Italian Quality Marking Institution (IMQ) and comply with current standards (EN 60570). A wide range of joints and accessories is available.



Binari elettrificati
electrified tracks

Index

1. MM	Pag. 244
2. LKM	Pag. 246
3. LKM DALI	Pag. 252
4. DKM	Pag. 258
5. 48VDC	Pag. 264





MM

Mini Main è un sistema di binari elettrificati monofase di facile installazione, compatibile con alcuni proiettori della collezione Ivela. Alimentazione alla rete monofase 230-250V, carico complessivo di 16A corrispondente a 3680/4000W.

Mini Main is a single-phase electrified track system, easy to install and compatible with some spotlights of the Ivela range. Connection to single phase 230-250V mains, total load of 16A corresponding to 3680/4000W.

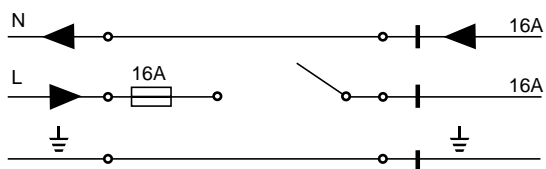

SCHEMA ELETTRICO

Il collegamento alla rete elettrica monofase 230/250V consente un carico complessivo di 16A che corrisponde a 3680/4000 Watt.

WIRING DIAGRAM

Connection to single-phase 230/250V mains allows a total load of 16A, corresponding to 3680/4000 Watt.

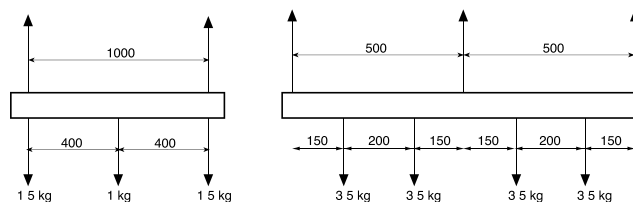

CAPACITÀ DI CARICO

Il binario può sopportare un carico di 4 Kg ogni 1000 mm. Nel caso di carico di 7 Kg, la distanza di fissaggio deve essere di 500 mm.

LOAD CAPACITY

Connection to single-phase 230/250V mains allows a total load of 16A, corresponding to 3680/4000 Watt.

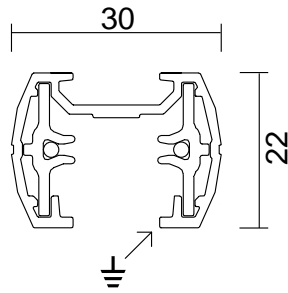

misure in mm / measurements in mm

□ Bianco
White■ Nero
Black

CE IP20

230/440V - 16A

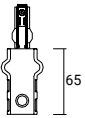

CODICE CODE	FINITURA FINISH	LUNGHEZZA LENGTH
7701-10-31	Bianco / White	1000mm
7701-20-31	Bianco / White	2000mm
7701-30-31	Bianco / White	3000mm
7701-10-30	Nero / Black	1000mm
7701-20-30	Nero / Black	2000mm
7701-30-30	Nero / Black	3000mm

ADATTATORI E ALIMENTATORI
ADAPTERS AND LIVE-ENDS7802-00-W31 Bianco / White
7802-00-W30 Nero / BlackAlimentazione
Live-end

4

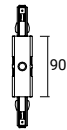
7803-00-W31 Bianco / White
7803-00-W30 Nero / BlackAlimentazione centrale
Central connector

6

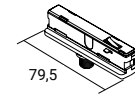
7800-00-31 Bianco / White
7800-00-30 Nero / BlackAdattatore elettromeccanico 6A
(M10x1) portata 5Kg
Electro/mechanical adapter 6A
(M10x1) with 5Kg load

1

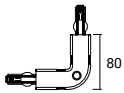
7805-00-W31 Bianco / White
7805-00-W30 Nero / BlackGiunto L
L joint

2

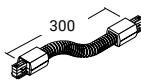
7810-00-W31 Bianco / White
7810-00-W30 Nero / BlackGiunto flessibile
Flexible joint

8

7804-00-W31 Bianco / White
7804-00-W30 Nero / BlackGiunto lineare elettrificato con
contatti / Electrical straight joint

10

7806-00-31 Bianco / White
7806-00-30 Nero / BlackKit sospensione con cavo
2000mm acciaio e piastrina 56mm
Suspension kit with 2000mm steel
wire and 56mm plate

10

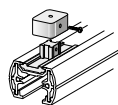
7807-02-W31 Bianco / White
7807-02-W30 Nero / BlackKit soffitto/parete a coppia
Wall/ceiling pair

50

7823-00-W31 Bianco / White
7823-00-W30 Nero / BlackTerminale di chiusura
Track cover

10



LKM

Accensioni, disponibile in quattro lunghezze per applicazioni a plafone e a sospensione. Le differenti versioni, da appoggio o da incasso, soddisfano ogni esigenza di installazione. La completezza degli accessori rende LKM ideale nella progettazione illuminotecnica per flessibilità e versatilità. Tensione di rete 230/250V. Tensione di rete industriale 380/440V. Carico complessivo 16A.

Light Kit Main is a system of three-phase tracks with three circuits, available in 4 different lengths for installation on the ceiling or on the wall. The range, which also includes recessed tracks, is suitable for several installation needs. The complete range of accessories makes LKM extremely flexible and versatile in lighting design. Power supply 230/250V. Industrial power supply 380/440V. Total load 16A.

TIPOLOGIE DI BINARI

Il binario trifase LKM è disponibile in due versioni. La versione da incasso è dotata di due alette laterali che permettono l'appoggio su controsoffitti o pannellature.

TRACK VERSION

The three-phase LKM track is available in 2 designs. The recessed one is supplied with two side wings, to allow installation in false ceilings and panels.

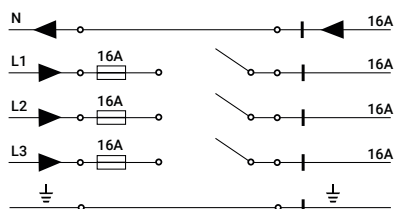
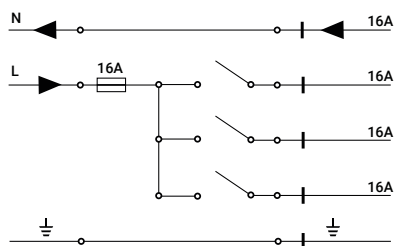

SCHEMI ELETTRICI

Il collegamento a una rete elettrica monofase 230/250V consente un carico complessivo di 16A, che corrisponde a 3680/4000 Watt suddivisibile su tre circuiti. Il collegamento alla rete elettrica trifase 230/400V consente un carico complessivo di 16A, che corrisponde a 11040 Watt ripartibili su tre circuiti (3x3680 Watt).

WIRING DIAGRAMS

The connections to a single phase 230/250V mains allows a total load of 16A, corresponding to 3680/4000 Watt, which can be divided among 3 circuits. The connection to a three phase 230/400V electricity mains allows a total load of 16A, corresponding to 11040 Watt, which can be divided among 3 circuits (3x3680 Watt).

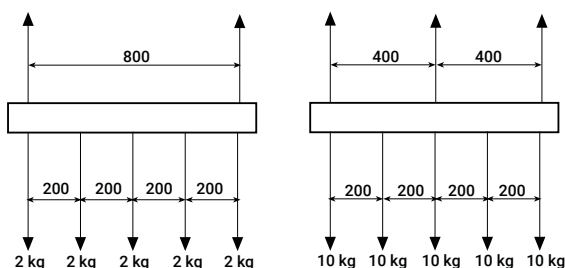

CAPACITÀ DI CARICO

I binari trifase LKM possono sopportare un carico di 2 Kg ogni 200 mm con una distanza massima fra i punti di fissaggio di 800 mm. Nel caso di carico di 10 Kg ogni 200 mm, la distanza di fissaggio deve essere di 400 mm.

LOAD CAPACITY

LKM three-phase tracks have a load capacity of 2 Kg every 200 mm, with a maximum distance of 800 mm between the fixing points. For a 10 Kg load every 200 mm, a maximum fixing distance of 400 mm is recommended.

Continuità della messa a terra (vista in planimetria dall'alto)

Continuity of the earthing
(top plan view)

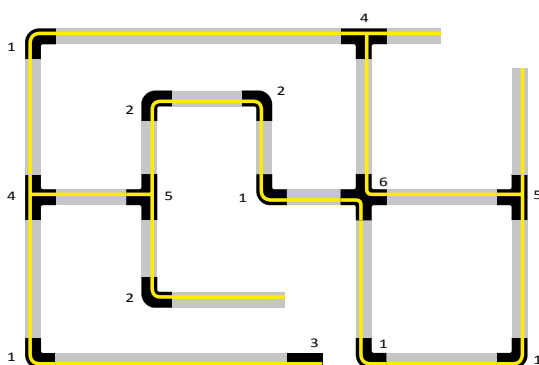

CONTINUITÀ DELLA MESSA A TERRA

Per una corretta installazione di tutti gli accessori che concorrono alla formazione di un impianto di binari trifase, ha grande importanza la continuità della linea di messa a terra tra ogni elemento. Il posizionamento dei conduttori di terra, infatti, deve essere consequenziale tra componente e componente.



Conduttore di terra con alimentazione sinistra L
Live-end with earth on the left L

Conduttore di terra con alimentazione destra R
Live-end with earth on the right R



1 Giunto L esterno
Outside L joint



2 Giunto L interno
Inside L joint



3 Alimentazione sinistra
Left live-end



4 Giunto T sinistro
Left T joint



5 Giunto T destro
Right T joint



6 Giunto a X
X joint

CONTINUITY OF THE EARTHING

For a correct installation of all the accessories in a three-phase track composition, the continuity of the earthing between each element has the highest importance. The earth conductors of each component must be positioned consistently.

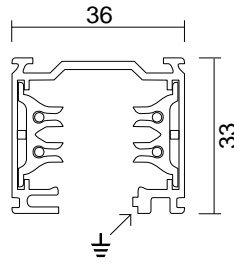

misure in mm / measurements in mm

Bianco White Nero Black Anodizzato naturale Satin silver

CE $\neq 850^\circ$ IP20

230/440V - 16A

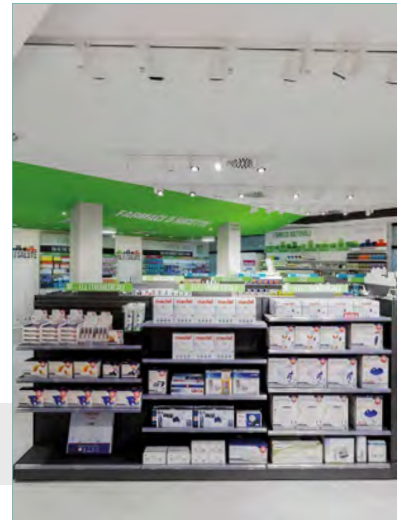

CODICE CODE	FINITURA FINISH	LUNGHEZZA LENGTH
7511-10-31	Bianco / White	1000mm
7511-20-31	Bianco / White	2000mm
7511-30-31	Bianco / White	3000mm
7511-40-31	Bianco / White	4000mm
7511-10-30	Nero / Black	1000mm
7511-20-30	Nero / Black	2000mm
7511-30-30	Nero / Black	3000mm
7511-40-30	Nero / Black	4000mm
7511-10-42	Anod. naturale / Satin silver	1000mm
7511-20-42	Anod. naturale / Satin silver	2000mm
7511-30-42	Anod. naturale / Satin silver	3000mm
7511-40-42	Anod. naturale / Satin silver	4000mm

ADATTATORI E ALIMENTATORI ADAPTERS AND LIVE-ENDS

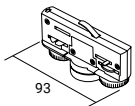

7600-00-31 Bianco / White
7600-00-30 Nero / Black
7600-00-20 Grigio / Grey

8 $\neq 850^\circ$
Adattatore elettromeccanico 6A
con portata 10Kg
Electro/mechanical adapter 6A with
10Kg load

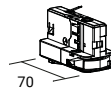

7558-00-31 Bianco / White
7558-00-30 Nero / Black
7558-00-20 Grigio / Grey

10 $\neq 850^\circ$
Adattatore elettromeccanico 6A
con portata 5Kg
Electro/mechanical adapter 6A with
5Kg load

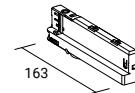

7557-00-31 Bianco / White
7557-00-30 Nero / Black
7557-00-20 Grigio / Grey

1 $\neq 850^\circ$
Adattatore elettromeccanico
con driver elettronico integrato
220/240V con portata 5Kg,
200-700mA 8,8-31W
Electro/mechanical adapter with
integrated electronic driver 220/240V
with 5Kg load, 200-700mA 8,8-31W

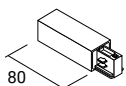

7652-10-W31 Bianco / White
7652-10-W30 Nero / Black
7652-10-W20 Grigio / Grey

10 $\neq 850^\circ$
Alimentazione destra
Right live-end

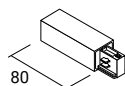

7652-11-W31 Bianco / White
7652-11-W30 Nero / Black
7652-11-W20 Grigio / Grey

10 $\neq 850^\circ$
Alimentazione sinistra
Left live-end

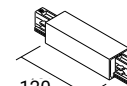

7653-10-W31 Bianco / White
7653-10-W30 Nero / Black
7653-10-W20 Grigio / Grey

2 $\neq 850^\circ$
Alimentazione sinistra
Left live-end

ACCESSORI
ACCESSORIES

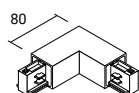

7655-10-W31 Bianco / White
7655-10-W30 Nero / Black
7655-10-W20 Grigio / Grey



Giunto L interno
Inside L joint

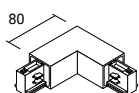

7655-11-W31 Bianco / White
7655-11-W30 Nero / Black
7655-11-W20 Grigio / Grey



Giunto L esterno
Outside L joint

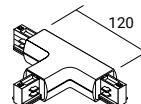

7656-10-W31 Bianco / White
7656-10-W30 Nero / Black
7656-10-W20 Grigio / Grey



Giunto T destro
Right T joint

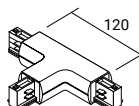

7656-11-W31 Bianco / White
7656-11-W30 Nero / Black
7656-11-W20 Grigio / Grey



Giunto T sinistro
Left T joint

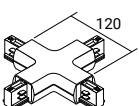

7657-10-W31 Bianco / White
7657-10-W30 Nero / Black
7657-10-W20 Grigio / Grey



Giunto X
X joint

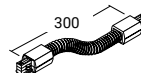

7658-10-W31 Bianco / White
7658-10-W30 Nero / Black
7658-10-W20 Grigio / Grey



Giunto flessibile
Flexible joint

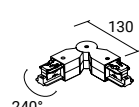

7660-00-W31 Bianco / White
7660-00-W30 Nero / Black
7660-00-W20 Grigio / Grey



Giunto mobile
Mobile joint

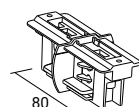

7604Q-10-W31 Bianco / White
7604Q-10-W30 Nero / Black



Giunto lineare elettrificato con
contatti e blocco
Electrical straight joint with stop

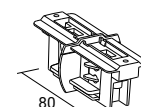

7654-10-W31 Bianco / White
7654-10-W30 Nero / Black



Giunto lineare con blocco senza
contatti (solo meccanico)
Mechanical straight joint with stop
without electrical contacts

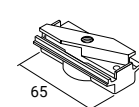

7625-00-31 Bianco / White
7625-00-30 Nero / Black



Adattatore meccanico
Mechanical adapter

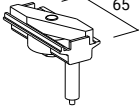

7618-00-31 Bianco / White
7618-00-30 Nero / Black



Adattatore meccanico con
bloccacavo e cavo acciaio
2000mm / Mechanical adapter with
automatic locking and 2000mm
steel wire

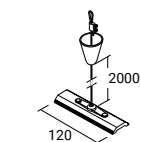

7606-05-31 Bianco / White
7606-05-30 Nero / Black



Kit sospensione con cavo acciaio
e piattina 120 mm
Suspension kit with steel wire and
120 mm plate

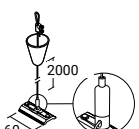

7606-06-31 Bianco / White
7606-06-30 Nero / Black



Kit sospensione con cavo
2000mm acciaio, piattina 60mm
e bloccacavo automatico
Suspension kit with 2000mm steel
wire, 60mm plate and automatic
locking device

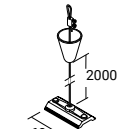

7606-00-31 Bianco / White
7606-00-30 Nero / Black



Kit sospensione con cavo acciaio
2000mm e piattina 60mm
Suspension kit with 2000mm steel
wire, 60mm plate and automatic
locking device

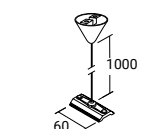

7626-00-00



Kit sospensione con tige 2000mm
e rosone traslucido / Suspension
kit with pipe and 2000mm
translucent ceiling base

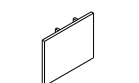

7659D-00-W31 Bianco / White
7659D-00-W30 Nero / Black
7659D-00-W20 Grigio / Grey



Terminale di chiusura
Track cover

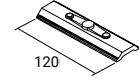

7606-04-00



Piattina
Plate



7609-00-00



Raccordo per adattatore
elettromeccanico M10X1
Nut for electro/mechanical
adapter M10x1

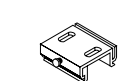

7607-00-00



Kit attacco soffitto
Ceiling kit

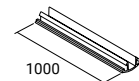

7624-00-31 Bianco / White
7624-00-30 Nero / Black



Copertura binario
Track cover

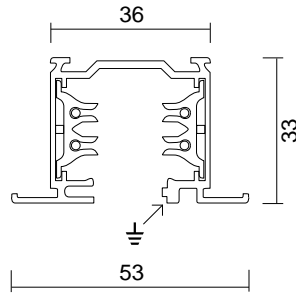

misure in mm / measurements in mm

Bianco
White

Nero
Black

CE **IP20**

230/440V - 16A



CODICE CODE	FINITURA FINISH	LUNGHEZZA LENGTH
7512-10-31	Bianco / White	1000mm
7512-20-31	Bianco / White	2000mm
7512-30-31	Bianco / White	3000mm
7512-40-31	Bianco / White	4000mm
7512-10-30	Nero / Black	1000mm
7512-20-30	Nero / Black	2000mm
7512-30-30	Nero / Black	3000mm
7512-40-30	Nero / Black	4000mm

ADATTATORI E ALIMENTATORI ADAPTERS AND LIVE-ENDS

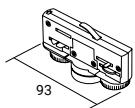

7600-00-31 Bianco / White
7600-00-30 Nero / Black

8

Adattatore elettromeccanico 6A
con portata 10Kg
Electro/mechanical adapter 6A with
10Kg load

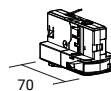

7558-00-31 Bianco / White
7558-00-30 Nero / Black

10

Adattatore elettromeccanico 6A
con portata 5Kg
Electro/mechanical adapter 6A with
5Kg load

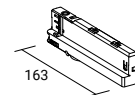

7557-00-31 Bianco / White
7557-00-30 Nero / Black

1

Adattatore elettromeccanico
con driver elettronico integrato
220/240V con portata 5Kg,
200-700mA 8,8-31W
Electro/mechanical adapter with
integrated electronic driver 220/240V
with 5Kg load, 200-700mA 8,8-31W

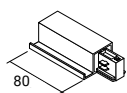

7662-10-W31 Bianco / White
7662-10-W30 Nero / Black

10

Alimentazione destra
Right live-end

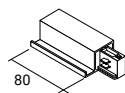

7662-11-W31 Bianco / White
7662-11-W30 Nero / Black

10

Alimentazione sinistra
Left live-end

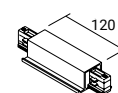

7663-10-W31 Bianco / White
7663-10-W30 Nero / Black

2

Alimentazione sinistra
Left live-end

ACCESSORI
ACCESSORIES



7604-10-W31 Bianco / White
7604-10-W30 Nero / Black

Giunto lineare elettrificato con contatti

Electrical straight joint

6

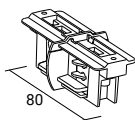

7654-10-W31 Bianco / White
7654-10-W30 Nero / Black

Giunto lineare con blocco senza contatti (solo meccanico)

Mechanical straight joint with stop without electrical contacts

6

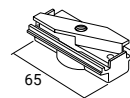

7625-00-31 Bianco / White
7625-00-30 Nero / Black

Adattatore meccanico

Mechanical adapter

10

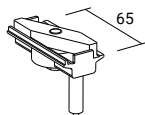

7618-00-31 Bianco / White
7618-00-30 Nero / Black

Adattatore meccanico con bloccacavo e cavo acciaio 2000mm / Mechanical adapter with automatic locking and 2000mm steel wire

10

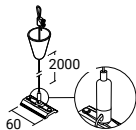

7606-06-31 Bianco / White
7606-06-30 Nero / Black

Kit sospensione con cavo 2000mm acciaio, piattina 60mm e bloccacavo automatico
Suspension kit with 2000mm steel wire, 60mm plate and automatic locking device

10

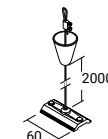

7606-00-31 Bianco / White
7606-00-30 Nero / Black

Kit sospensione con cavo acciaio 2000mm e piattina 60mm
Suspension kit with 2000mm steel wire, 60mm plate and automatic locking device

10



7664-00-48

Sospensione per controsoffitto
Suspension for false ceiling

10



7659ID-00-W31 Bianco / White
7659ID-00-W30 Nero / Black

Terminale di chiusura
Track cover

10



7609-00-00

Raccordo per adattatore elettromeccanico M10X1

Nut for electro/mechanical adapter M10x1

10



7607-00-00

Kit attacco soffitto
Ceiling kit

10

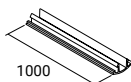

7624-00-31 Bianco / White
7624-00-30 Nero / Black

Copertura binario
Track cover

10

LKM DALI

Il binario trifase dimmerabile LKM DALI è disponibile in differenti lunghezze per applicazioni a plafone, a sospensione e a incasso. Il binario LKM DALI è idoneo per l'applicazione dei principali sistemi di programmazione luminosa (DALI, DMX, 1-10V), con due conduttori di segnale DALI in aggiunta alle tre fasi. Tensione di rete 230/250V. Carico complessivo 16A, corrispondente a 3680/4000W.

The three-phase dimmable track LKM DALI is available in different lengths for installation on the ceiling, suspended or recessed. The LKM DALI track is applicable with the main systems in use to control light (DALI, DMX, 1-10V), with two DALI signal conductors added to the three phases. Power supply 230/250V. Total load 16A, corresponding to 3680/4000W.

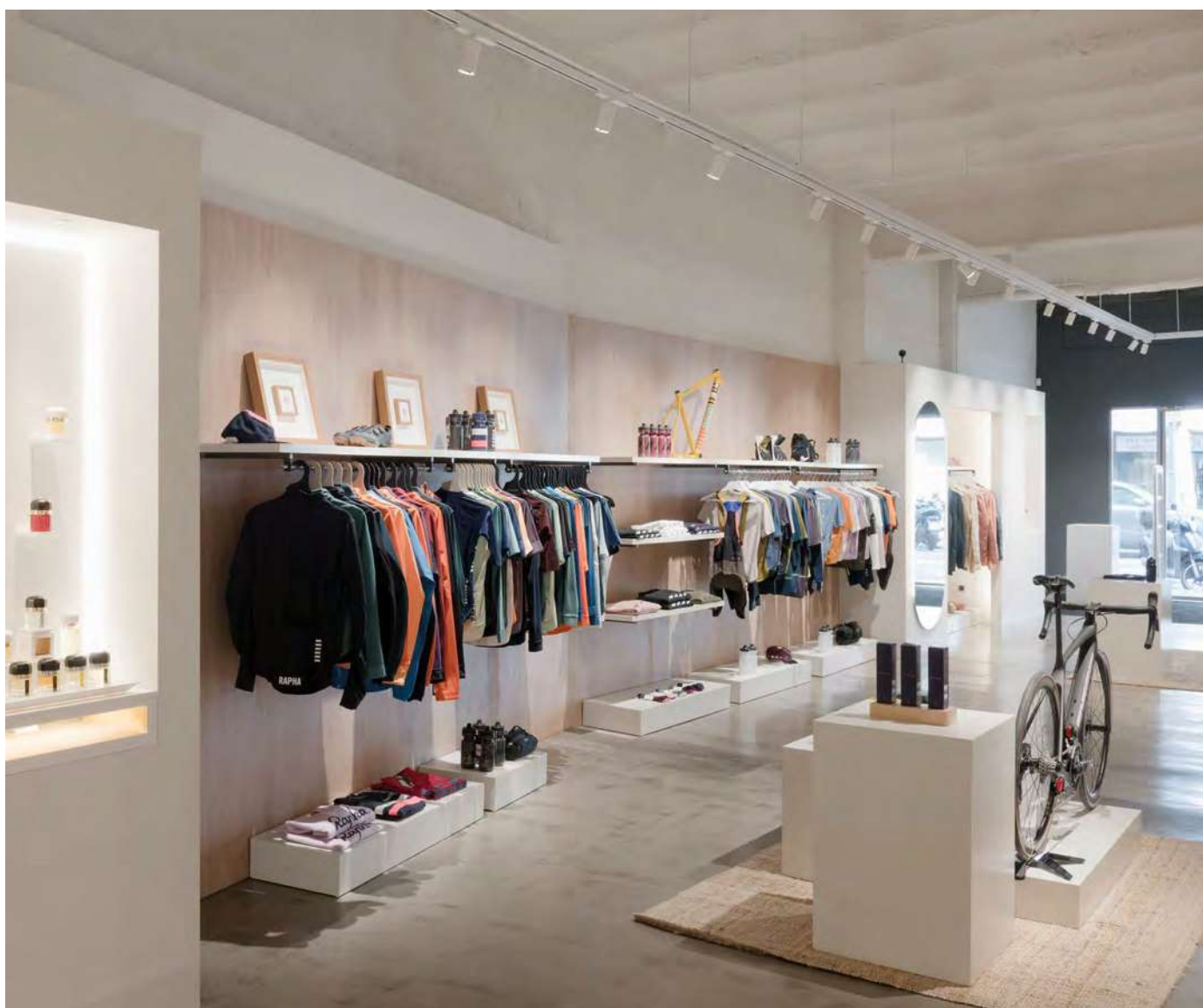

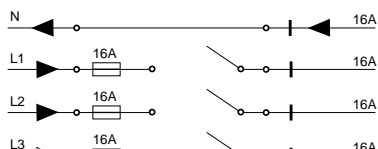
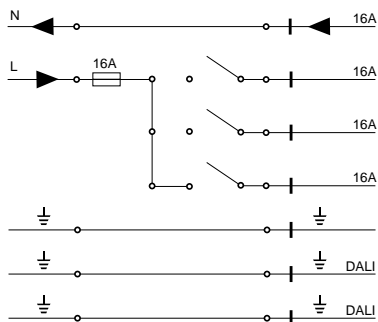

SCHEMI ELETTRICI

Il collegamento a una rete elettrica monofase 230/250V consente un carico complessivo di 16A, che corrisponde a 3680/4000 Watt suddivisibile su tre circuiti. Il collegamento alla rete elettrica trifase 230/400V consente un carico complessivo di 16A, che corrisponde a 11040 Watt ripartibili su tre circuiti (3x3680 Watt).

WIRING DIAGRAMS

The connections to a single phase 230/250V mains allows a total load of 16A, corresponding to 3680/4000 Watt, which can be divided among 3 circuits. The connection to a three phase 230/400V electricity mains allows a total load of 16A, corresponding to 11040 Watt, which can be divided among 3 circuits (3x3680 Watt).

CAPACITÀ DI CARICO

I binari trifase LKM possono sopportare un carico di 2 Kg ogni 200 mm con una distanza massima fra i punti di fissaggio di 800 mm. Nel caso di carico di 10 Kg ogni 200 mm, la distanza di fissaggio deve essere di 400 mm.

LOAD CAPACITY

LKM three-phase tracks have a load capacity of 2 Kg every 200 mm, with a maximum distance of 800 mm between the fixing points. For a 10 Kg load every 200 mm, a maximum fixing distance of 400 mm is recommended.

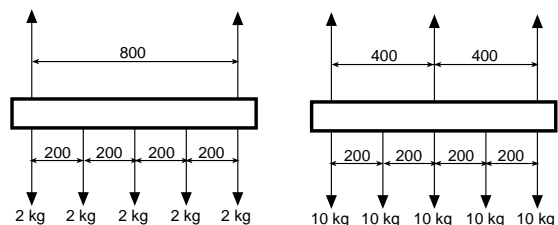

Per la continuità della messa a terra consultare la pagina del binario LKM

For continuity of the earthing see LKM track page

LKM DALI

QUADRO / SQUARE

Binari elettrificati
Electrified tracks



Scheda tecnica
Datasheet

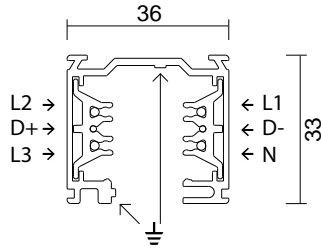

misure in mm / measurements in mm

Bianco
White

Nero
Black

CE **IP20**

230/440V - 16A



CODICE CODE	FINITURA FINISH	LUNGHEZZA LENGTH
7540-10-31	Bianco / White	1000mm
7540-20-31	Bianco / White	2000mm
7540-30-31	Bianco / White	3000mm
7540-40-31	Bianco / White	4000mm
7540-10-30	Nero / Black	1000mm
7540-20-30	Nero / Black	2000mm
7540-30-30	Nero / Black	3000mm
7540-40-30	Nero / Black	4000mm

ADATTATORI E ALIMENTATORI ADAPTERS AND LIVE-ENDS

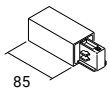

7541-10-W31 Bianco / White
7541-10-W30 Nero / Black

10

Alimentazione destra
Right live-end

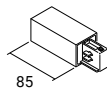

7541-11-W31 Bianco / White
7541-11-W30 Nero / Black

10

Alimentazione sinistra
Left live-end

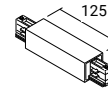

7542-10-W31 Bianco / White
7542-10-W30 Nero / Black

2

Alimentazione centrale e giunto
lineare / Central connector and
straight joint

ACCESSORI ACCESSORIES

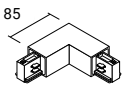

7543-10-W31 Bianco / White
7543-10-W30 Nero / Black

4

Giunto L interno
Inside L joint

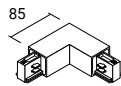

7543-11-W31 Bianco / White
7543-11-W30 Nero / Black

4

Giunto L esterno
Inside L esterno

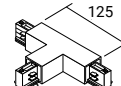

7544-10-W31 Bianco / White
7544-10-W30 Nero / Black

2

Giunto T destro
Right T joint

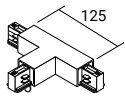

7544-11-W31 Bianco / White
7544-11-W30 Nero / Black



Giunto T sinistro
 Left T joint

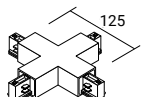

7545-10-W31 Bianco / White
7545-10-W30 Nero / Black



Giunto X
 X joint

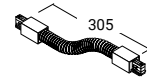

7546-10-W31 Bianco / White
7546-10-W30 Nero / Black

Giunto flessibile
 Flexible joint

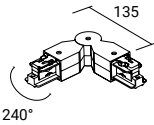

7547-00-W31 Bianco / White
7547-00-W30 Nero / Black

Giunto mobile
 Mobile joint

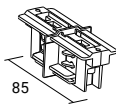

7548Q-10-W31 Bianco / White
7548Q-10-W30 Nero / Black

Giunto lineare elettrificato con
 contatti e blocco / Electrical joint
 with stop

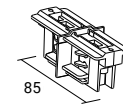

7549-10-W31 Bianco / White
7549-10-W30 Nero / Black

Giunto lineare con blocco senza
 contatti (solo meccanico)
 Mechanical straight joint with stop
 without electrical contacts

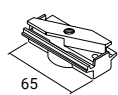

7625-00-31 Bianco / White
7625-00-30 Nero / Black

Adattatore meccanico
 Mechanical adapter

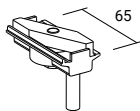

7618-00-31 Bianco / White
7618-00-30 Nero / Black

Adattatore meccanico con
 bloccacavo e cavo acciaio
 2000mm / Mechanical adapter
 with automatic locking and
 2000mm steel wire

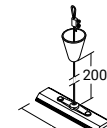

7606-05-31 Bianco / White
7606-05-30 Nero / Black

Kit sospensione con cavo
 acciaio 2000mm e piattina
 120mm / Suspension kit with
 2000mm steel wire and 120 mm
 plate

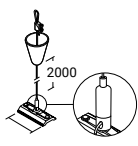

7606-06-31 Bianco / White
7606-06-30 Nero / Black

Kit sospensione con cavo
 acciaio 2000mm, piattina 60mm
 e bloccacavo automatico
 Suspension kit with 2000mm steel
 wire, 60mm plate and automatic
 locking device

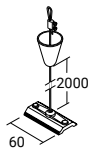

7606-00-31 Bianco / White
7606-00-30 Nero / Black

Kit sospensione con cavo
 acciaio 2000mm e piattina
 60mm / Suspension kit with
 2000mm steel wire and 60mm
 plate

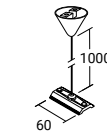

7626-00-00

Kit sospensione con tige
 1000mm e rosone traslucido
 Suspension kit with 1000mm pipe
 and translucent ceiling base



7659-00-W31 Bianco / White
7659-00-W30 Nero / Black

Terminale di chiusura
 Dead end

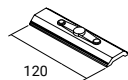

7606-04-00

Piattina
 Plate



7609-00-00

Raccordo per adattatore
 elettromeccanico M10x1
 Nut for electro/mechanical
 adapter M10x1



7607-00-00

Kit attacco al soffitto
 Ceiling kit

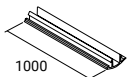

7624-00-31 Bianco / White
7624-00-30 Nero / Black

Copertura binario
 Track cover

LKM DALI

INCASSO / RECESSED

Binari elettrificati
Electrified tracks



Scheda tecnica
Datasheet

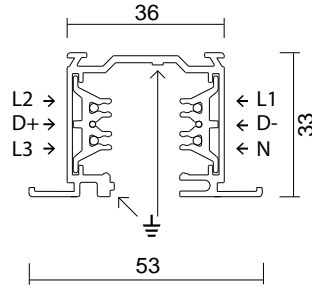

misure in mm / measurements in mm

Bianco
White

Nero
Black

CE **IP20**

230/440V - 16A



CODICE CODE	FINITURA FINISH	LUNGHEZZA LENGTH
7560-10-31	Bianco / White	1000mm
7560-20-31	Bianco / White	2000mm
7560-30-31	Bianco / White	3000mm
7560-40-31	Bianco / White	4000mm
7560-10-30	Nero / Black	1000mm
7560-20-30	Nero / Black	2000mm
7560-30-30	Nero / Black	3000mm
7560-40-30	Nero / Black	4000mm

ACCESSORI ACCESSORIES

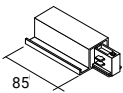

7561-10-W31 Bianco / White
7561-10-W30 Nero / Black

Alimentazione destra
Right live-end

10

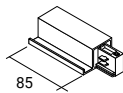

7561-11-W31 Bianco / White
7561-11-W30 Nero / Black

Alimentazione sinistra
Left live-end

10

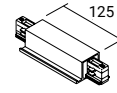

7562-10-W31 Bianco / White
7562-10-W30 Nero / Black

Alimentazione centrale e giunto
lineare / Central connector and
straight joint

2

ACCESSORI
ACCESSORIES

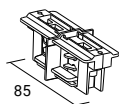

7548Q-10-W31 Bianco / White
7548Q-10-W30 Nero / Black

6 850'

Giunto lineare elettrificato con contatti e blocco / Electrical joint with stop

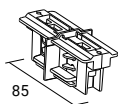

7549-10-W31 Bianco / White
7549-10-W30 Nero / Black

6 850'

Giunto lineare con blocco senza contatti (solo meccanico) / Mechanical straight joint with stop without electrical contacts

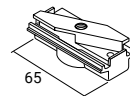

7625-00-31 Bianco / White
7625-00-30 Nero / Black

10 850'

Adattatore meccanico / Mechanical adapter

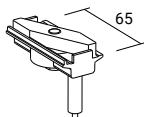

7618-00-31 Bianco / White
7618-00-30 Nero / Black

10 850'

Adattatore meccanico con bloccacavo e cavo acciaio 2000mm / Mechanical adapter with automatic locking and 2000mm steel wire

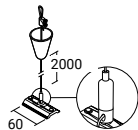

7606-06-31 Bianco / White
7606-06-30 Nero / Black

10 850'

Kit sospensione con cavo 2000mm acciaio, piattina 60mm e bloccacavo automatico / Suspension kit with 2000mm steel wire, 60mm plate and automatic locking device

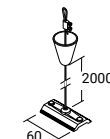

7606-00-31 Bianco / White
7606-00-30 Nero / Black

10 850'

Kit sospensione con cavo acciaio 2000mm e piattina 60mm / Suspension kit with 2000mm steel wire, 60mm plate and automatic locking device



7664-00-48

10 850'

Sospensione per controsoffitto / Suspension for false ceiling



7659I-00-W31 Bianco / White
7659I-00-W30 Nero / Black

10 850'

Terminale di chiusura / Dead end



7609-00-00

10 850'

Raccordo per adattatore elettromeccanico M10X1 / Nut for electro/mechanical adapter M10x1



7607-00-00

10 850'

Kit attacco soffitto / Ceiling kit

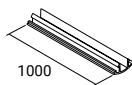

7624-00-31 Bianco / White
7624-00-30 Nero / Black

10 850'

Copertura binario / Track cover



DKM

Il binario monofase dimmerabile DKM è disponibile in differenti lunghezze per applicazioni a plafone, a sospensione e a incasso. Il binario DKM è idoneo per l'applicazione dei principali sistemi di programmazione luminosa (DALI, DMX, 1-10V). Alimentazione alla rete monofase 230-250V, carico complessivo di 16A corrispondente a 3680/4000W. Sono disponibili proiettori con driver DALI e appositi adattatori per binari dimmerabili DKM.

The single-phase dimmable track DKM is available in different lengths for installation on the ceiling, suspended or recessed. The DKM track is applicable with the main systems in use to control light (DALI, DMX, 1-10V). Connection to single phase 230-250V mains, total load of 16A corresponding to 3680/4000W. Spotlights including DALI drivers and specific adapters are available for DKM dimmable tracks.



Luce dinamica

La possibilità di gestire, da un sistema remoto, l'intensità dei flussi luminosi di ogni singolo punto luce in modo indipendente consente un elevato livello di personalizzazione e di valorizzazione delle aree espositive. I sistemi di controllo dell'illuminazione consentono un reale miglioramento dell'efficienza energetica e permettono di creare scenografie della luce in diverse applicazioni, quali ambienti espositivi, musei, centri commerciali.

Dynamic light

Remote light control for the variation of the light intensity of each fitting in an independent way allows both a high level of customization and the right emphasis in exhibition areas. Light control systems make it possible to achieve real improvements in terms of energetic efficiency and to create scenic effects with light for different applications such as exhibition areas, museums, shopping centres.

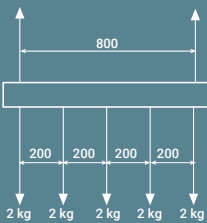

CAPACITÀ DI CARICO LOAD CAPACITY

Il binario può sopportare un carico di 2 Kg ogni 200 mm. Nel caso di carico di 10 Kg ogni 200 mm, la distanza di fissaggio deve essere di 400 mm.

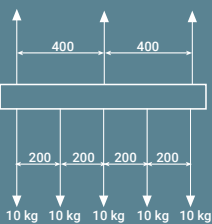

The track has a load capacity of 2 Kg every 200 mm. In case of 10 Kg load every 200 mm, a distance of 400 mm between the fixing points is recommended.

SCHEMA ELETTRICO

Il collegamento alla rete elettrica monofase 230/250V consente un carico complessivo di 16A che corrisponde a 3680/4000 Watt.

WIRING DIAGRAM

Connection to single phase 230/250V mains allows a total load of 16A corresponding to 3680/4000W.



ACCESSORI

Il binario DKM é corredato da una serie di accessori dedicati (adattatore e connettori di alimentazione), e di altri in comune con il sistema quadro LKM. É obbligatorio l'uso dello specifico adattatore elettromeccanico cod. 7559.

ACCESSORIES

The DKM track system includes a range of specific accessories such as an adapter and live-ends, together with a set of other accessories, that are in common with the LKM square system. The use of the specific electro-mechanic adapter code 7559 is compulsory.

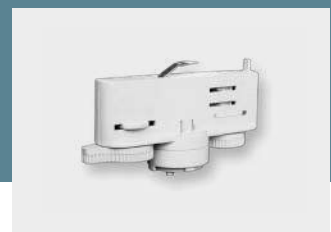

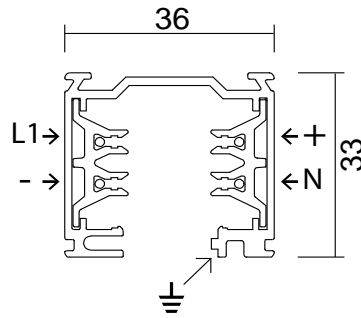

misure in mm / measurements in mm

Bianco
White

Nero
Black

CE IP20

230/250V - 16A



CODICE CODE	FINITURA FINISH	LUNGHEZZA LENGTH
7520-10-31	Bianco / White	1000mm
7520-20-31	Bianco / White	2000mm
7520-30-31	Bianco / White	3000mm
7520-40-31	Bianco / White	4000mm
7520-10-30	Nero / Black	1000mm
7520-20-30	Nero / Black	2000mm
7520-30-30	Nero / Black	3000mm
7520-40-30	Nero / Black	4000mm

ADATTATORI E ALIMENTATORI ADAPTERS AND LIVE-ENDS

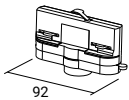

92

7559-00-31 Bianco / White
7559-00-30 Nero / Black

Adattatore elettromeccanico
DALI 6A con portata 10Kg
DALI electro/mechanical adapter 6A
with 10Kg load

10

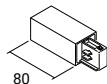

80

7651-10-W31 Bianco / White
7651-10-W30 Nero / Black

Alimentazione destra
Right live-end

10

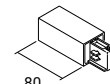

80

7651-11-W31 Bianco / White
7651-11-W30 Nero / Black

Alimentazione sinistra
Left live-end

10

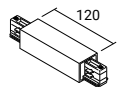

120

7661-10-W31 Bianco / White
7661-10-W30 Nero / Black

Alimentazione centrale e giunto
lineare / Central connector and
straight joint

2

ACCESSORI ACCESSORIES

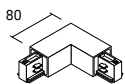

80

7655-10-W31 Bianco / White
7655-10-W30 Nero / Black

Giunto L interno
Inside L joint

4

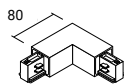

80

7655-11-W31 Bianco / White
7655-11-W30 Nero / Black

Giunto L esterno
Inside L esterno

4

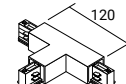

120

7656-10-W31 Bianco / White
7656-10-W30 Nero / Black

Giunto T destro
Right T joint

2

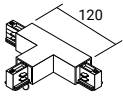

7656-11-W31 Bianco / White
7656-11-W30 Nero / Black



Giunto T sinistro
 Left T joint

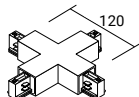

7657-10-W31 Bianco / White
7657-10-W30 Nero / Black



Giunto X
 X joint

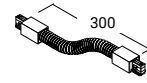

7658-10-W31 Bianco / White
7658-10-W30 Nero / Black



Giunto flessibile
 Flexible joint

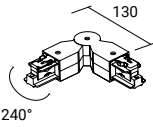

7660-00-W31 Bianco / White
7660-00-W30 Nero / Black



Giunto mobile
 Mobile joint

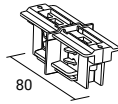

7604Q-10-W31 Bianco / White
7604Q-10-W30 Nero / Black



Giunto lineare elettrificato con
 contatti e blocco / Electrical joint
 with stop

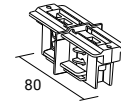

7654-10-W31 Bianco / White
7654-10-W30 Nero / Black



Giunto lineare elettrificato con
 contatti e blocco / Electrical joint
 with stop

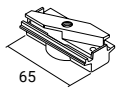

7625-00-31 Bianco / White
7625-00-30 Nero / Black



Adattatore meccanico
 Mechanical adapter

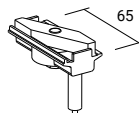

7618-00-31 Bianco / White
7618-00-30 Nero / Black



Adattatore meccanico con
 bloccacavo e cavo acciaio
 2000mm / Mechanical adapter
 with automatic locking and
 2000mm steel wire

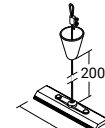

7606-05-31 Bianco / White
7606-05-30 Nero / Black



Kit sospensione con cavo
 acciaio 2000mm e piattina
 120mm / Suspension kit with
 2000mm steel wire and 120 mm
 plate

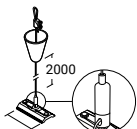

7606-06-31 Bianco / White
7606-06-30 Nero / Black

Kit sospensione con cavo
 acciaio 2000mm, piattina 60mm
 e bloccacavo automatico
 Suspension kit with 2000mm steel
 wire, 60mm plate and automatic
 locking device

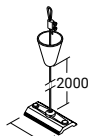

7606-00-31 Bianco / White
7606-00-30 Nero / Black



Kit sospensione con cavo
 acciaio 2000mm e piattina
 60mm / Suspension kit with
 2000mm steel wire and 60mm
 plate

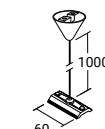

7626-00-00



Kit sospensione con tige
 1000mm e rosone traslucido /
 Suspension kit with 1000mm pipe
 and translucent ceiling base



7659-00-W31 Bianco / White
7659-00-W30 Nero / Black



Terminale di chiusura
 Dead end

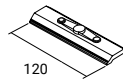

7606-04-00



Piattina
 Plate



7609-00-00



Raccordo per adattatore
 elettromeccanico M10x1
 Nut for electro/mechanical
 adapter M10x1



7607-00-00



Kit attacco al soffitto
 Ceiling kit

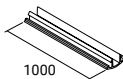

7624-00-31 Bianco / White
7624-00-30 Nero / Black



Copertura binario
 Track cover

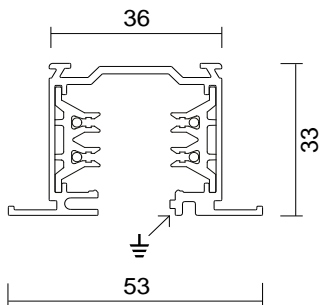

misure in mm / measurements in mm

Bianco
White

Nero
Black

CE **IP20**

230/250V - 16A



CODICE CODE	FINITURA FINISH	LUNGHEZZA LENGTH
7521-10-31	Bianco / White	1000mm
7521-20-31	Bianco / White	2000mm
7521-30-31	Bianco / White	3000mm
7521-40-31	Bianco / White	4000mm
7521-10-30	Nero / Black	1000mm
7521-20-30	Nero / Black	2000mm
7521-30-30	Nero / Black	3000mm
7521-40-30	Nero / Black	4000mm

ADATTATORI E ALIMENTATORI

ADAPTERS AND LIVE-ENDS

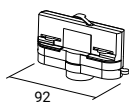

7559-00-31 Bianco / White
7559-00-30 Nero / Black

Adattatore elettromeccanico
DALI 6A con portata 10Kg
DALI electro/mechanical adapter 6A
with 10Kg load

10

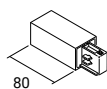

7665-10-W31 Bianco / White
7665-10-W30 Nero / Black

Alimentazione destra
Right live-end

8

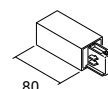

7665-11-W31 Bianco / White
7665-11-W30 Nero / Black

Alimentazione sinistra
Left live-end

8

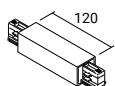

7666-10-W31 Bianco / White
7666-10-W30 Nero / Black

Alimentazione centrale e giunto
lineare / Central connector and
straight joint

2

ACCESSORI
ACCESSORIES



7604-10-31 Bianco / White
7604-10-30 Nero / Black

Giunto lineare elettrificato con
contatti / Electrical traight joint

6

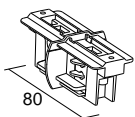

7654-10-W31 Bianco / White
7654-10-W30 Nero / Black

Giunto lineare con blocco senza
contatti (solo meccanico)
Mechanical straight joint without
electrical contacts

6

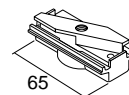

7625-00-31 Bianco / White
7625-00-30 Nero / Black

Adattatore meccanico
Mechanical adapter

10

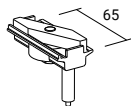

7618-00-31 Bianco / White
7618-00-30 Nero / Black

Adattatore meccanico con
bloccacavo e cavo acciaio
2000mm / Mechanical adapter with
automatic locking and 2000 mm steel
wire

10



7664-00-48

Sospensione per controsoffitto
Suspension for false ceiling

10



7659-00-W31 Bianco / White
7659-00-W30 Nero / Black

Terminale di chiusura
Dead end

10



7609-00-00

Raccordo per adattatore
elettromeccanico M10X1

Nut for electro/mechanical
adapter M10x1

10



7607-00-00

Kit attacco soffitto
Ceiling kit

10

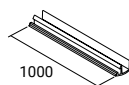

7624-00-31 Bianco / White
7624-00-30 Nero / Black

Copertura binario 1000mm
1000mm track cover

10

48V_{DC}

Binari elettrificati a bassa tensione 48V per applicazioni a soffitto, a parete, a sospensione e per installazioni a incasso trimless in controsoffitti. Predisposti per alloggiare i proiettori e sospensioni provvisti di adattatore 48V, sono realizzati in lega di alluminio estruso, verniciato poliestere. I due conduttori per 48V portano anche il segnale DALI, consentendo la regolazione dinamica della luce.

48V low voltage electrified tracks for ceiling, wall, suspension applications and for trimless recessed installations in false ceilings. They are compatible with spotlights and pendants equipped with 48V adapter. They are made of extruded aluminium alloy, polyester painted. The two 48V conductors can transmit also the DALI signal, allowing for the dynamic control of light.

Caratteristiche tecniche

I binari elettrificati sono costruiti in lega di alluminio estruso. I cavi conduttori in rame sono alloggiati all'interno di profilati estrusi in PVC ad alta resistenza di isolamento. Certificati dall'Istituto Italiano Marchio di Qualità (IMQ), sono conformi alle norme vigenti (EN 60570).

I sistemi comprendono un'ampia varietà di accessori e di giunti di collegamento.

Technical Specifications

Electrified tracks are made of extruded aluminium alloy. The copper wires are located inside extruded PVC profiles with high insulating properties. They are certified by the Italian Quality Marking Institution (IMQ) and they comply with current standards (EN 60570).

Every system includes a wide range of joints and accessories.



Continuità del polo positivo (vista in planimetria dall'alto)

Continuity of the positive pole
(top plan view)

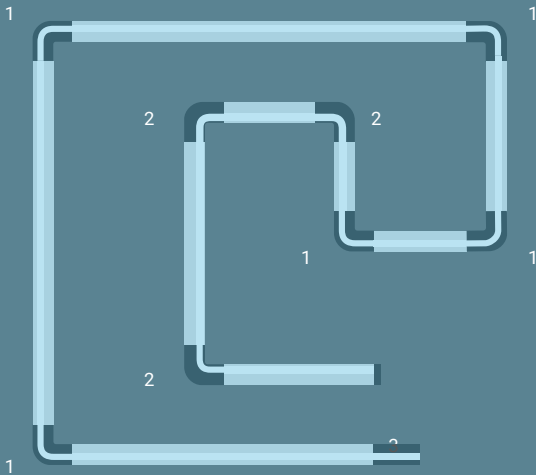

1 Giunto L esterno
Outside L joint



2 Giunto L interno
Inside L joint



3 Alimentazione sinistra
Left live-end

Capacità di carico

Il binario può sopportare un carico di 4 Kg ogni 1000 mm. Nel caso di carico di 4 Kg, ogni 200 mm, la distanza di fissaggio deve essere di 500 mm. Il carico massimo è di 720 W (48VDC - 15 A).

Load capacity

The track has a load capacity of 4 Kg every 1000 mm. For a 4 Kg load every 200 mm a maximum fixing distance of 500 mm is recommended. Maximum load is 720 W (48VDC - 15 A).

Binario 48V Polarizzato

Per una corretta installazione di tutti gli accessori che concorrono alla formazione di un impianto di binari 48V, è importante seguire la continuità della linea di positivo tra ogni elemento.

Polarized 48V Track

The continuity of the positive line between each element is important for a correct installation of all the accessories in a 48V track composition.

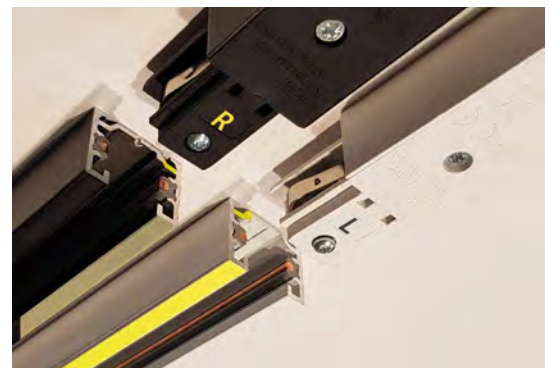

Alimentazione destra R
Right live-end R

Alimentazione sinistra L
Left live-end L

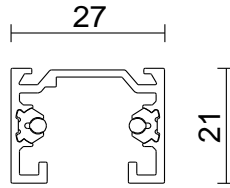

misure in mm / measurements in mm

Bianco mat
Mat white

Nero
Black

CE **IP20**

48V_{DC} - 15A



CODICE CODE	FINITURA FINISH	LUNGHEZZA LENGTH
6445-10-21	Bianco mat / Mat white	1000mm
6445-20-21	Bianco mat / Mat white	2000mm
6445-30-21	Bianco mat / Mat white	3000mm
6445-10-16	Nero / Black	1000mm
6445-20-16	Nero / Black	2000mm
6445-30-16	Nero / Black	3000mm

ALIMENTATORI LIVE-ENDS

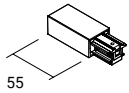

6451-10-31 Bianco / White
6451-10-30 Nero / Black

10

Alimentazione destra
Right live-end

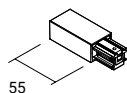

6451-11-31 Bianco / White
6451-11-30 Nero / Black

10

Alimentazione sinistra
Left live-end

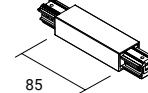

6452-00-31 Bianco / White
6452-00-30 Nero / Black

5

Alimentazione centrale
Central connector

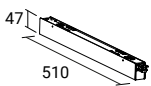

6503-10-31 Bianco / White
6503-10-30 Nero / Black

Alimentazione destra con
trasformatore integrato 150W
Right live-end with 150W integrated
transformer

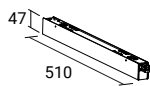

6503-11-31 Bianco / White
6503-11-30 Nero / Black

Alimentazione sinistra con
trasformatore integrato 150W
Left live-end with 150W integrated
transformer

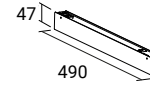

6506-00-31 Bianco / White
6506-00-30 Nero / Black

Alimentazione con trasformatore
integrato 150W per binario sospeso
Right live-end with 150W integrated
transformer for suspended track

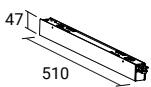

6504-10-31 Bianco / White
6504-10-30 Nero / Black

Alimentazione destra con
trasformatore integrato 150W DALI
Right live-end with 150W integrated
transformer DALI

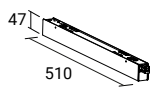

6504-11-31 Bianco / White
6504-11-30 Nero / Black

Alimentazione sinistra con
trasformatore integrato 150W DALI
Left live-end with 150W integrated
transformer DALI

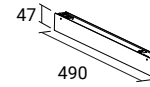

6507-00-31 Bianco / White
6507-00-30 Nero / Black

Alimentazione con trasformatore
integrato 150W DALI per binario sospeso
Right live-end with 150W DALI integrated
transformer for suspended track

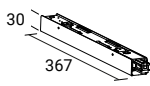

6505-10-31 Bianco / White
6505-10-30 Nero / Black

Alimentazione destra con
trasformatore integrato 100W
Right live-end with 100W integrated
transformer

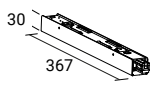

6505-11-31 Bianco / White
6505-11-30 Nero / Black

Alimentazione sinistra con
trasformatore integrato 100W
Left live-end with 100W integrated
transformer

ACCESSORI ACCESSORIES

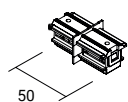

6453-00-31 Bianco / White
6453-00-30 Nero / Black

25

Giunto lineare
Straight joint

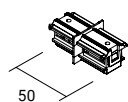

6454-10-31 Bianco / White
6454-10-30 Nero / Black

25

Giunto lineare senza contatti
Mechanical joint without electrical contacts

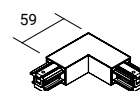

6455-10-31 Bianco / White
6455-10-30 Nero / Black

5

Giunto L interno
Inside L joint

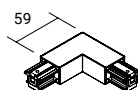

6455-11-31 Bianco / White
6455-11-30 Nero / Black

5

Giunto L esterno
Outside L joint

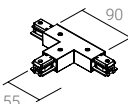

6464-10-31 Bianco / White
6464-10-30 Nero / Black

4

Giunto T destro
Right T joint

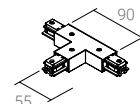

6464-11-31 Bianco / White
6464-11-30 Nero / Black

4

Giunto T sinistro
Left T joint

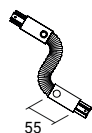

6456-00-31 Bianco / White
6456-00-30 Nero / Black

2

Giunto flessibile
Flexible joint

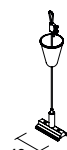

6458-06-31 Bianco / White
6458-06-30 Nero / Black

10

Kit sospensione con cavo acciaio 2000 mm, piattina e bloccacavo automatico
Suspension kit with 2000 mm steel wire, plate and automatic locking device



6458-00-31 Bianco / White
6458-00-30 Nero / Black

10

Kit sospensione con cavo acciaio 2000 mm e piattina / Suspension kit with 2000 mm steel wire and plate



6459-20-31 Bianco / White
6459-20-30 Nero / Black

10

Kit soffitto/parete a coppia
Wall/ceiling pair



6463-00-00

10

Kit attacco soffitto
Ceiling kit

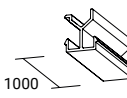

6461-00-31 Bianco / White
6461-00-30 Nero / Black

10

Copertura binario
Track cover

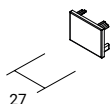

6460-00-31 Bianco / White
6460-00-30 Nero / Black

10

Chiusura
Dead end

TRASFORMATORI BINARIO 48VDC QUADRO 48VDC SQUARE TRACK TRANSFORMERS

81-09000

Trasformatore PWM 100W 230V/48V per uso remoto
100W 230V/48V PWM transformer for remote use

81-09001

Trasformatore PWM 200W 230V/48V per uso remoto
200W 230V/48V PWM transformer for remote use

81-90122

Trasformatore PWM 300W 230V/48V per uso remoto
300W 230V/48V PWM transformer for remote use

6465-03-31

Trasformatore elettronico 150W 220-240V/48VDC DALI per uso remoto / 150W 220-240V/48VDC DALI electronic transformer for remote use

DISPOSITIVI DI REGOLAZIONI PER TRASFORMATORI DIMMERS AND CONTROLLERS FOR TRANSFORMERS

81-90089

Dimmer Casambi Bluetooth 48V 4 canali
(per trasformatori cod. 81-09000, 81-09001, 81-90122)
Bluetooth Casambi dimmer 48V 4 channels
(for transformers codes 81-09000, 81-09001, 81-90122)

81-90124

Dimmer DALI (per trasformatori cod. 81-09000, 81-09001, 81-90122)
DALI dimmer (for transformers codes 81-09000, 81-09001, 81-90122)

81-90123

Dimmer PWM (per trasformatori cod. 81-09000, 81-09001, 81-90122)
PWM dimmer (for transformers codes 81-09000, 81-09001, 81-90122)

81-90128

Controller Bluetooth DALI (per trasformatore cod. 6465-03-31)
Bluetooth DALI controller (for transformer code 6465-03-31)

48V_{DC}

INCASSO TL / TL RECESSED

Binari elettrificati
Electrified tracks



Scheda tecnica
Datasheet

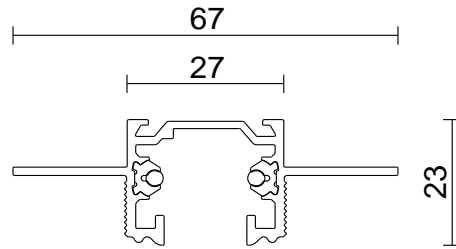

misure in mm / measurements in mm

Bianco
White

Nero
Black

CE **IP20**

48V_{DC} - 15A

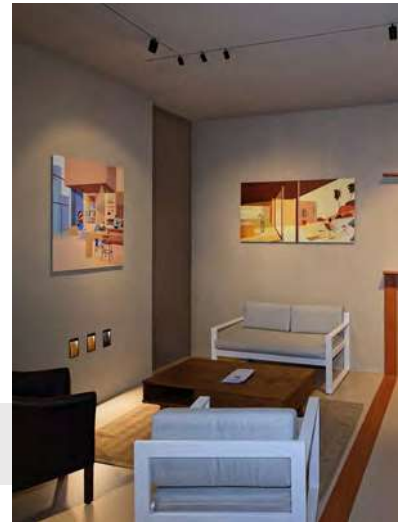

CODICE CODE	FINITURA FINISH	LUNGHEZZA LENGTH
6446-10-31	Bianco mat / White	1000mm
6446-20-31	Bianco mat / White	2000mm
6446-30-31	Bianco mat / White	3000mm
6446-10-30	Nero / Black	1000mm
6446-20-30	Nero / Black	2000mm
6446-30-30	Nero / Black	3000mm

ALIMENTATORI LIVE-ENDS

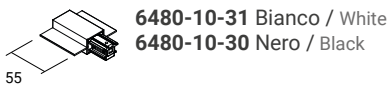

6480-10-31 Bianco / White
6480-10-30 Nero / Black

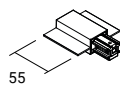

6480-11-31 Bianco / White
6480-11-30 Nero / Black

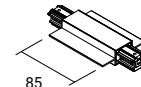

6481-00-31 Bianco / White
6481-00-30 Nero / Black

10

Alimentazione destra
Right live-end

10

Alimentazione sinistra
Left live-end

5

Alimentazione centrale
Central connection

ACCESSORI ACCESSORIES

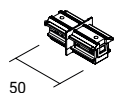

6453-00-31 Bianco / White
6453-00-30 Nero / Black

25

Giunto lineare
Straight joint

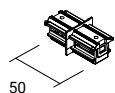

6454-10-31 Bianco / White
6454-10-30 Nero / Black

25

Giunto lineare senza contatti
Mechanical joint without electrical contacts

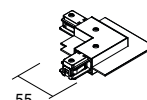

6484-10-31 Bianco / White
6484-10-30 Nero / Black

5

Giunto L interno
Inside L joint

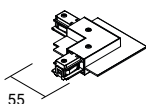

6484-11-31 Bianco / White
6484-11-30 Nero / Black

5

Giunto L esterno
Outside L joint

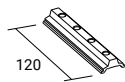

6457-00-00

1

Piattina (obbligatoria per la
congiunzione di più binari)

Plate (compulsory for the connection
between tracks)

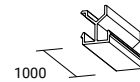

6461-00-31 Bianco / White
6461-00-30 Nero / Black

10

Copertura binario
Track cover

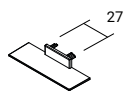

6483-00-31 Bianco / White
6483-00-30 Nero / Black

10

Chiusura
Dead end

TRASFORMATORI BINARIO 48VDC QUADRO 48VDC SQUARE TRACK TRANSFORMERS

81-09000

Trasformatore PWM 100W 230V/48V per uso remoto
100W 230V/48V PWM transformer for remote use

81-09001

Trasformatore PWM 200W 230V/48V per uso remoto
200W 230V/48V PWM transformer for remote use

81-90122

Trasformatore PWM 300W 230V/48V per uso remoto
300W 230V/48V PWM transformer for remote use

6465-03-31

Trasformatore elettronico 150W 220-240V/48VDC DALI
per uso remoto / 150W 220-240V/48VDC DALI electronic
transformer for remote use

DISPOSITIVI DI REGOLAZIONI PER TRASFORMATORI DIMMERS AND CONTROLLERS FOR TRANSFORMERS

81-90089

Dimmer Casambi Bluetooth 48V 4 canali
(per trasformatori cod. 81-09000, 81-09001, 81-90122)
Bluetooth Casambi dimmer 48V 4 channels
(for transformers codes 81-09000, 81-09001, 81-90122)

81-90124

Dimmer DALI (per trasformatori cod. 81-09000, 81-09001, 81-90122)
DALI dimmer (for transformers codes 81-09000, 81-09001, 81-90122)

81-90123

Dimmer PWM (per trasformatori cod. 81-09000, 81-09001, 81-90122)
PWM dimmer (for transformers codes 81-09000, 81-09001, 81-90122)

81-90128

Controller Bluetooth DALI (per trasformatore cod. 6465-03-31)
Bluetooth DALI controller (for transformer code 6465-03-31)





Faretti

spotlights

Punti luce, illuminati da sorgenti LED. Prodotti decorativi caratterizzati da varie possibilità di emissione di luce a seconda delle ottiche. Disponibili in diversi modelli e in differenti modalità di installazione, adattandosi a tutti i progetti di illuminazione.

Points of light, illuminated by LED sources. Decorative products featuring various possibilities of light emission depending on the optics. Available in different models and in different installation modes, adapting to all lighting projects.

Accentua i dettagli

Accentuate the details

Fori e cilindri di dimensioni ridotte liberano un fascio luminoso, direzionato dove necessario. In un continuo dialogo di presenza-assenza, si adattano al mondo dell'interior e dell'exterior in maniera efficace.

Miniaturised cut outs and cylinders release a directed beam of light where needed. In a continuous dialogue of presence and absence, they speak the language of both interior and exterior with equal ease.





Grazie alle nuove tecnologie, la miniaturizzazione dell'oggetto luminoso permette di focalizzare l'attenzione su una corretta illuminazione, creando sinergia tra la luce e lo spazio.

New technologies allow the miniaturization of the luminaires, focusing on a correct lighting design and creating a synergy between light and space.

Faretti / Spotlights

Index

1. Faretti a binario

Track lights

	Pag.
Miniperfetto MM 9/12W	278
Miniperfetto LKM 9/12W	279
Microperfetto LKM 26W	280
Microperfetto LKM 26W phase-cut	281
Perfetto compact LKM 18W	282
Perfetto compact LKM 26W	283
Perfetto compact LKM 30W	284
Perfetto puro LKM 32W	285
Perfetto puro LKM 37W	286
Perfetto puro Power LKM 53W	287
Perfetto puro LKM ZOOM 29W	288
DRIM LKM max.100W	289
Perfetto compact DKM DALI 26W	290
Perfetto puro DKM DALI 32W	292
Perfetto puro DKM DALI 37W	293
3546 TRACK	294

2. Faretti a binario 48Vdc

Track lights 48Vdc

	Pag.
Microperfetto PWM 18W	298
Microperfetto PWM 21W	299
Microperfetto PWM 26W	300
Microperfetto DALI 21W	301
Microperfetto DALI 26W	302
Microperfetto Dim to warm	303

3. Faretti da incasso

Recessed spotlights

	Pag.
Nary 30	304
Copenaghen 41	305
RA 4	306
RA 7	307
Vienna 70	308
Monaco 70	309
RA 8 DIXIT LED	310
RA 8 L DIXIT LED	311
RA 8 Q DIXIT LED	312
RA 8 L TL DIXIT LED	314
RA 8 TL DIXIT LED	315
RA 11 DIXIT LED	316
RA 11 Q DIXIT LED	317
RA 11 TL DIXIT LED	318
RA 16	319
Sao 113	320
Sao 174	321
Sao 244	322
Sao 279	323
Downlight 113	324
Downlight 174	325
Downlight 232	326
RA 14 DIXIT LED	327
RA 20 DIXIT LED	328
RA 23 SP DIXIT LED	329
Nicosia 51	330
RA 8 DIXIT LED	331
RA 11 DIXIT LED	332
RA 17 DIXIT LED	333
KIEV 158	334
KIEV 188	335

4. Cielo stellato

Starry sky

	Pag.
Cielo stellato	338

5. Cestelli

Baskets

	Pag.
Lakin 83 / Ardea 102	342
Nemi 93T / Nemi 93Q	343
Madama 79 / Latina 76	344
Sandy 86 / Clark 90	345

6. SpotLED

SpotLEDs

	Pag.
∅50 - 3W / 9W	348
∅50 - 11W RGB	349

7. Faretti a plafone

Ceiling lights

	Pag.
Perfetto compact BASE	352
PF 15 / PF 22	354
PF 19 / PF 30	355

8. Faretti applique

Wall lights

	Pag.
Giada - 30W / Giada 200	358
AP LINE - 30W	359



9. Faretti a sospensione

Suspension spotlight

	Pag.
Floot - 33/51W	362
Zeppel 400	363

10. Faretti da esterno

Exterior luminaires

	Pag.
Glen 36T / Glen 36TC	368/369
Glen 36Q / Glen 36QC	370/371
Dema 45T / Dema 45TC	372/373
Dema 45Q / Dema 45QC	374/375
Brixia 50E	376
Verona 50E	377
Venezia 50E	378
Yola 80	380
Taylor 80	381
Armenia 80	382
Baxter 85C	384
Baxter 83C	385
Nauto	386
Walker LED - Walker	387
Baxter 175	388
Achille 190LED	389
Achille 320LED	390
Stilled	391
Serie 500 / Serie 500 Grid	392
Lito	394
Lito 230	395
Maxilito	396
Dedo 100	397
Nigel 202	398
Nigel 250	399
Nigel Bar 965	400
270	402
270P / 330	403
250T / 270T	404
270TP / 312T	405
340T	406
380T / 380T LED	407

Faretti a binario

track lights



La luce d'accento fornita da questi prodotti, enfatizza e valorizza oggetti, spazi e finiture.

The accent light provided by these products emphasizes and enhances objects, spaces and finishes.



Elementi di luce

Lighting elements

Proiettori compatti per binari elettrificati, caratterizzati da linee semplici ed eleganti, progettati per ospitare LED ad alta efficienza. Una vasta gamma di apparecchi con diverse finiture, CCT e dimensioni.

La disponibilità di differenti fasci luminosi, accessori ottici e l'orientamento del corpo, consentono molteplici soluzioni e regie luminose nel retail, in spazi commerciali, musei ed aree espositive.

Compact projectors for electrified tracks, characterized by simple and elegant lines, designed to accommodate highly efficient LEDs. A wide range of fixtures is available with different finishes, CCT, and sizes. The availability of different beam angles, optical accessories, and body orientation allows for multiple lighting solutions and setups in retail, commercial spaces, museums, and exhibition areas.



MINIPERFETTO MM

9W/12W

Faretti a binario
Track lights



Scheda tecnica
Datasheet

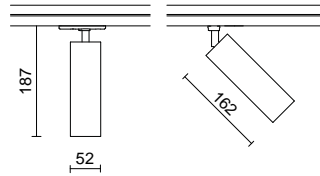

0,5 Kg

PER BINARI ELETTTRIFICATI MONOFASE MM
FOR MM SINGLE-PHASE ELECTRIFIED TRACKS

misure in mm / measurements in mm

Bianco mat
Mat white

Nero
Black

CE IP20

220/240V - 50/60Hz



CODICE
CODE

DATI TECNICI
TECHNICAL DATA

	LUMEN	WATT	CCT (K)	CRI	OTTICA OPTIC	FINITURA FINISH
748-2592CX-21	914	9	2700	90	30°	Bianco mat / Mat white
748-2592CX-16	914	9	2700	90	30°	Nero / Black
748-2592BX-21	972	9	3000	90	30°	Bianco mat / Mat white
748-2592BX-16	972	9	3000	90	30°	Nero / Black
748-2592AX-21	1108	9	4000	90	30°	Bianco mat / Mat white
748-2592AX-16	1108	9	4000	90	30°	Nero / Black

9W: regolabile sulla fase / dimmable on the mains

748-1592CX-21	1172	12	2700	90	30°	Bianco mat / Mat white
748-1592CX-16	1172	12	2700	90	30°	Nero / Black
748-1592BX-21	1221	12	3000	90	30°	Bianco mat / Mat white
748-1592BX-16	1221	12	3000	90	30°	Nero / Black
748-1592AX-21	1391	12	4000	90	30°	Bianco mat / Mat white
748-1592AX-16	1391	12	4000	90	30°	Nero / Black

OPZIONALE
OPTIONAL

CODICE
CODE

DESCRIZIONE
DESCRIPTION

28-3979-100 Cilindro oro satinato
Satinated gold baffle



28-4536-30 Frangiluce alveolare
Honeycomb



CODICE
CODE

DESCRIZIONE
DESCRIPTION

14769 Adattatore per plafone
Ceiling adapter



14768 Adattatore per cartongesso da
utilizzare con cod. 14769
Adapter for plasterboard to be used with
code 14769



MINIPERFETTO LKM

9W/12W

Faretti a binario
Track lights



Scheda tecnica
Datasheet

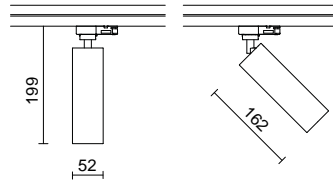

0,5 Kg

PER BINARI ELETTRIFICATI TRIFASE LKM
FOR LKM THREE-PHASE ELECTRIFIED TRACKS

misure in mm / measurements in mm

Bianco mat
Mat white

Nero
Black

CE IP20

220/240V - 50/60Hz



CODICE CODE

DATI TECNICI TECHNICAL DATA

	LUMEN	WATT	CCT (K)	CRI	OTTICA OPTIC	FINITURA FINISH
748-2693CX-21	914	9	2700	90	30°	Bianco mat / Mat white
748-2693CX-16	914	9	2700	90	30°	Nero / Black
748-2693BX-21	972	9	3000	90	30°	Bianco mat / Mat white
748-2693BX-16	972	9	3000	90	30°	Nero / Black
748-2693AX-21	1108	9	4000	90	30°	Bianco mat / Mat white
748-2693AX-16	1108	9	4000	90	30°	Nero / Black

9W: regolabile sulla fase / dimmable on the mains

748-1693CX-21	1172	12	2700	90	30°	Bianco mat / Mat white
748-1693CX-21	1172	12	2700	90	30°	Nero / Black
748-1693BX-21	1221	12	3000	90	30°	Bianco mat / Mat white
748-1693BX-16	1221	12	3000	90	30°	Nero / Black
748-1693AX-21	1391	12	4000	90	30°	Bianco mat / Mat white
748-1693AX-21	1391	12	4000	90	30°	Nero / Black

OPZIONALE OPTIONAL

**CODICE
CODE** **DESCRIZIONE
DESCRIPTION**
28-3979-100 Cilindro oro satinato
Satinated gold baffle



28-4536-30 Frangiluce alveolare
Honeycomb



**CODICE
CODE** **DESCRIZIONE
DESCRIPTION**
14769 Adattatore per plafone
Ceiling adapter



14768 Adattatore per cartongesso da
utilizzare con cod. 14769
Adapter for plasterboard to be used with
code 14769



MICROPERFETTO LKM

26W

Faretti a binario
Track lights



Scheda tecnica
Datasheet

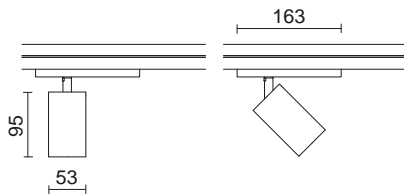

0,4 Kg

PER BINARI ELETTTRIFICATI TRIFASE LKM
FOR LKM THREE-PHASE ELECTRIFIED TRACKS

misure in mm / measurements in mm

Bianco mat
Mat white

Nero
Black

CE $\neq 850^\circ$ IP20

220/240V - 50/60Hz



CODICE
CODE

DATI TECNICI
TECHNICAL DATA

	LUMEN	WATT	CCT (K)	CRI	OTTICA OPTIC	FINITURA FINISH
760-169CY-21	1813	26	2700	90	24°	Bianco mat / Mat white
760-169CY-16	1813	26	2700	90	24°	Nero / Black
760-169CX-21	1813	26	2700	90	30°	Bianco mat / Mat white
760-169CX-16	1813	26	2700	90	30°	Nero / Black
760-169CV-21	1813	26	2700	90	45°	Bianco mat / Mat white
760-169CV-16	1813	26	2700	90	45°	Nero / Black
760-169BY-21	1890	26	3000	90	24°	Bianco mat / Mat white
760-169BY-16	1890	26	3000	90	24°	Nero / Black
760-169BX-21	1890	26	3000	90	30°	Bianco mat / Mat white
760-169BX-16	1890	26	3000	90	30°	Nero / Black
760-169BV-21	1890	26	3000	90	45°	Bianco mat / Mat white
760-169BV-16	1890	26	3000	90	45°	Nero / Black
760-169AY-21	1918	26	4000	90	24°	Bianco mat / Mat white
760-169AY-16	1918	26	4000	90	24°	Nero / Black
760-169AX-21	1918	26	4000	90	30°	Bianco mat / Mat white
760-169AX-16	1918	26	4000	90	30°	Nero / Black
760-169AV-21	1918	26	4000	90	45°	Bianco mat / Mat white
760-169AV-16	1918	26	4000	90	45°	Nero / Black

OPZIONALE
OPTIONAL

CODICE
CODE

DESCRIZIONE
DESCRIPTION

28-4139-100 Cilindro oro satinato
Satinated gold baffle



28-4163-30 Frangiluce alveolare
Honeycomb



28-4073-61 Vetro sabbato
Frosted glass



CODICE
CODE

DESCRIZIONE
DESCRIPTION

28-4073-103 Vetro ellittico
Elliptical spread lens



MICROPERFETTO LKM CUT-PHASE

26W - DIMMERABILE A TAGLIO DI FASE / MAINS DIMMABLE

Faretti a binario
Track lights



Scheda tecnica
Datasheet

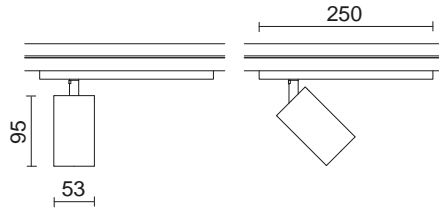

0,5 Kg

PER BINARI ELETRIFICATI TRIFASE LKM
FOR LKM THREE-PHASE ELECTRIFIED TRACKS

misure in mm / measurements in mm

Bianco mat
Mat white

Nero
Black

CE **IP20**

220/240V - 50/60Hz



CODICE
CODE

DATI TECNICI
TECHNICAL DATA

	LUMEN	WATT	CCT (K)	CRI	OTTICA OPTIC	FINITURA FINISH
760-169CYMD-21	1813	26	2700	90	24°	Bianco mat / Mat white
760-169CYMD-16	1813	26	2700	90	24°	Nero / Black
760-169CXMD-21	1813	26	2700	90	30°	Bianco mat / Mat white
760-169CXMD-16	1813	26	2700	90	30°	Nero / Black
760-169CVMD-21	1813	26	2700	90	45°	Bianco mat / Mat white
760-169CVMD-16	1813	26	2700	90	45°	Nero / Black
760-169BYMD-21	1890	26	3000	90	24°	Bianco mat / Mat white
760-169BYMD-16	1890	26	3000	90	24°	Nero / Black
760-169BXMD-21	1890	26	3000	90	30°	Bianco mat / Mat white
760-169BXMD-16	1890	26	3000	90	30°	Nero / Black
760-169BVMD-21	1890	26	3000	90	45°	Bianco mat / Mat white
760-169BVMD-16	1890	26	3000	90	45°	Nero / Black
760-169AYMD-21	1918	26	4000	90	24°	Bianco mat / Mat white
760-169AYMD-16	1918	26	4000	90	24°	Nero / Black
760-169AXMD-21	1918	26	4000	90	30°	Bianco mat / Mat white
760-169AXMD-16	1918	26	4000	90	30°	Nero / Black
760-169AVMD-21	1918	26	4000	90	45°	Bianco mat / Mat white
760-169AVMD-16	1918	26	4000	90	45°	Nero / Black

OPZIONALE
OPTIONAL

CODICE
CODE

DESCRIZIONE
DESCRIPTION

28-4139-100 Cilindro oro satinato
Satinated gold baffle



28-4163-30 Frangiluce alveolare
Honeycomb



28-4073-61 Vetro sabbato
Frosted glass



CODICE
CODE

DESCRIZIONE
DESCRIPTION

28-4073-103 Vetro ellittico
Elliptical spread lens



PERFETTO COMPACT LKM CUT-PHASE

18W - DIMMERABILE A TAGLIO DI FASE / MAINS DIMMABLE

Faretti a binario
Track lights



Scheda tecnica
Datasheet

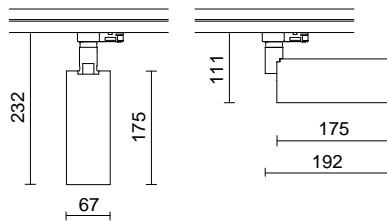

1,0 Kg

PER BINARI ELETRIFICATI TRIFASE LKM
FOR LKM THREE-PHASE ELECTRIFIED TRACKS

misure in mm / measurements in mm

Bianco mat
Mat white

Nero
Black

CE IP20

220/240V - 50/60Hz

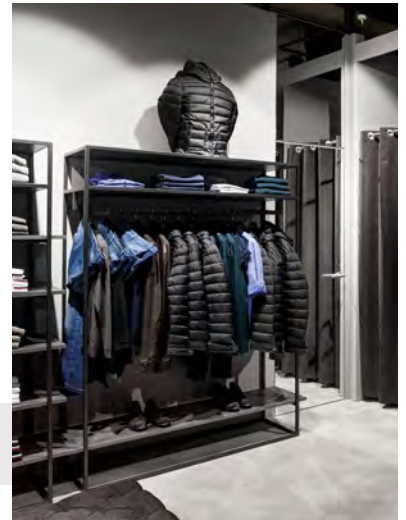

CODICE
CODE

DATI TECNICI
TECHNICAL DATA

	LUMEN	WATT	CCT (K)	CRI	OTTICA OPTIC	FINITURA FINISH
751-1613CYMD-21	1680	18	2700	85	20°	Bianco mat / Mat white
751-1613CYMD-16	1680	18	2700	85	20°	Nero / Black
751-1613CXMD-21	1680	18	2700	85	29°	Bianco mat / Mat white
751-1613CXMD-16	1680	18	2700	85	29°	Nero / Black
751-1613CWMD-21	1680	18	2700	85	42°	Bianco mat / Mat white
751-1613CWMD-16	1680	18	2700	85	42°	Nero / Black
751-1613BYMD-21	1750	18	3000	85	20°	Bianco mat / Mat white
751-1613BYMD-16	1750	18	3000	85	20°	Nero / Black
751-1613BXMD-21	1750	18	3000	85	29°	Bianco mat / Mat white
751-1613BXMD-16	1750	18	3000	85	29°	Nero / Black
751-1613BWMD-21	1750	18	3000	85	42°	Bianco mat / Mat white
751-1613BWMD-16	1750	18	3000	85	42°	Nero / Black
751-1613AYMD-21	1978	18	4000	85	20°	Bianco mat / Mat white
751-1613AYMD-16	1978	18	4000	85	20°	Nero / Black
751-1613AXMD-21	1978	18	4000	85	29°	Bianco mat / Mat white
751-1613AXMD-16	1978	18	4000	85	29°	Nero / Black
751-1613AWMD-21	1978	18	4000	85	42°	Bianco mat / Mat white
751-1613AWMD-16	1978	18	4000	85	42°	Nero / Black

18W: regolabile sulla fase / dimmable on the mains

OPZIONALE
OPTIONAL

CODICE CODE	DESCRIZIONE DESCRIPTION		CODICE CODE	DESCRIZIONE DESCRIPTION	
28-9004-30	Cilindro antiabbagliamento Snoot		14769	Adattatore per plafone Ceiling adapter	
28-4080-30	Frangiluce alveolare (da utilizzare con cod. 28-9004-30) Honeycomb (to be used with code 28-9004-30)		14768	Adattatore per cartongesso da utilizzare con cod. 14769 Adapter for plasterboard to be used with code 14769	
28-3905-47	Schermo di chiusura in termoplastico trasparente Closing screen in clear thermoplastic material				

PERFETTO COMPACT LKM

26W

Faretti a binario
Track lights



Scheda tecnica
Datasheet

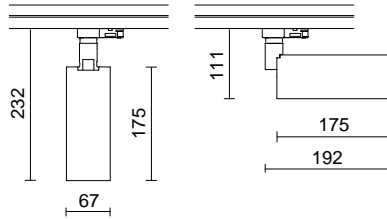

1,0 Kg



PER BINARI ELETRIFICATI TRIFASE LKM
FOR LKM THREE-PHASE ELECTRIFIED TRACKS

misure in mm / measurements in mm

Bianco mat
Mat white

Nero
Black

CE **IP20**

220/240V - 50/60Hz

CODICE
CODE

DATI TECNICI
TECHNICAL DATA

	LUMEN	WATT	CCT (K)	CRI	OTTICA OPTIC	FINITURA FINISH
751-2613CY-21	2187	26	2700	85	20°	Bianco mat / Mat white
751-2613CY-16	2187	26	2700	85	20°	Nero / Black
751-2613CX-21	2187	26	2700	85	29°	Bianco mat / Mat white
751-2613CX-16	2187	26	2700	85	29°	Nero / Black
751-2613CW-21	2187	26	2700	85	42°	Bianco mat / Mat white
751-2613CW-16	2187	26	2700	85	42°	Nero / Black
751-2613BY-21	2278	26	3000	85	20°	Bianco mat / Mat white
751-2613BY-16	2278	26	3000	85	20°	Nero / Black
751-2613BX-21	2278	26	3000	85	29°	Bianco mat / Mat white
751-2613BX-16	2278	26	3000	85	29°	Nero / Black
751-2613BW-21	2278	26	3000	85	42°	Bianco mat / Mat white
751-2613BW-16	2278	26	3000	85	42°	Nero / Black
751-2613AY-21	2574	26	4000	85	20°	Bianco mat / Mat white
751-2613AY-16	2574	26	4000	85	20°	Nero / Black
751-2613AX-21	2574	26	4000	85	29°	Bianco mat / Mat white
751-2613AX-16	2574	26	4000	85	29°	Nero / Black
751-2613AW-21	2574	26	4000	85	42°	Bianco mat / Mat white
751-2613AW-16	2574	26	4000	85	42°	Nero / Black

OPZIONALE
OPTIONAL

CODICE CODE	DESCRIZIONE DESCRIPTION	CODICE CODE	DESCRIZIONE DESCRIPTION
28-9004-30	Cilindro antiabbagliamento Snoot	14769	Adattatore per plafone Ceiling adapter
28-4080-30	Frangiluce alveolare (da utilizzare con cod. 28-9004-30) Honeycomb (to be used with code 28-9004-30)	14768	Adattatore per cartongesso da utilizzare con cod. 14769 Adapter for plasterboard to be used with code 14769
28-3905-47	Schermo di chiusura in termoplastico trasparente Closing screen in clear thermoplastic material		

PERFETTO COMPACT LKM

30W

Faretti a binario
Track lights



Scheda tecnica
Datasheet

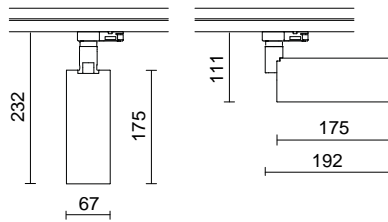

1,0 Kg

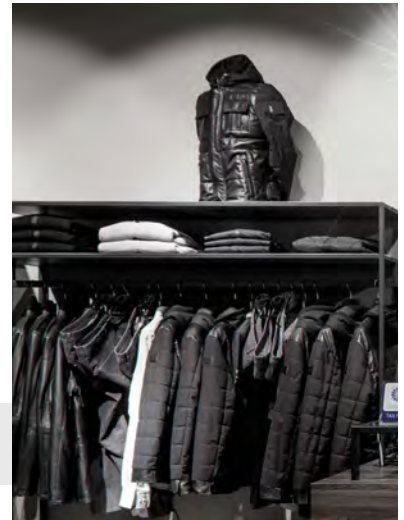

PER BINARI ELETTRIFICATI TRIFASE LKM
FOR LKM THREE-PHASE ELECTRIFIED TRACKS

misure in mm / measurements in mm

Bianco mat
Mat white Nero
Black

CE IP20

220/240V - 50/60Hz

CODICE
CODE

DATI TECNICI
TECHNICAL DATA

	LUMEN	WATT	CCT (K)	CRI	OTTICA OPTIC	FINITURA FINISH
751-3613CY-21	2450	30	2700	85	20°	Bianco mat / Mat white
751-3613CY-16	2450	30	2700	85	20°	Nero / Black
751-3613CX-21	2450	30	2700	85	29°	Bianco mat / Mat white
751-3613CX-16	2450	30	2700	85	29°	Nero / Black
751-3613CW-21	2450	30	2700	85	42°	Bianco mat / Mat white
751-3613CW-16	2450	30	2700	85	42°	Nero / Black
751-3613BY-21	2552	30	3000	85	20°	Bianco mat / Mat white
751-3613BY-16	2552	30	3000	85	20°	Nero / Black
751-3613BX-21	2552	30	3000	85	29°	Bianco mat / Mat white
751-3613BX-16	2552	30	3000	85	29°	Nero / Black
751-3613BW-21	2552	30	3000	85	42°	Bianco mat / Mat white
751-3613BW-16	2552	30	3000	85	42°	Nero / Black
751-3613AY-21	2884	30	4000	85	20°	Bianco mat / Mat white
751-3613AY-16	2884	30	4000	85	20°	Nero / Black
751-3613AX-21	2884	30	4000	85	29°	Bianco mat / Mat white
751-3613AX-16	2884	30	4000	85	29°	Nero / Black
751-3613AW-21	2884	30	4000	85	42°	Bianco mat / Mat white
751-3613AW-16	2884	30	4000	85	42°	Nero / Black

OPZIONALE
OPTIONAL

CODICE CODE	DESCRIZIONE DESCRIPTION		CODICE CODE	DESCRIZIONE DESCRIPTION	
28-9004-30	Cilindro antiabbagliamento Snoot		14769	Adattatore per plafone Ceiling adapter	
28-4080-30	Frangiluce alveolare (da utilizzare con cod. 28-9004-30) Honeycomb (to be used with code 28-9004-30)		14768	Adattatore per cartongesso da utilizzare con cod. 14769 Adapter for plasterboard to be used with code 14769	
28-3905-47	Schermo di chiusura in termoplastico trasparente Closing screen in clear thermoplastic material				

PERFETTO PURO LKM

32W

Faretti a binario
Track lights

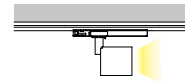

Scheda tecnica
Datasheet

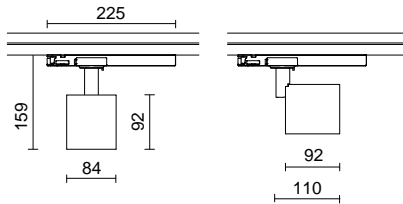

0,9 Kg

PER BINARI ELETTRIFICATI TRIFASE LKM
FOR LKM THREE-PHASE ELECTRIFIED TRACKS

misure in mm / measurements in mm

Bianco mat
Mat white

Nero
Black

CE \neq 850° IP20

220/240V - 50/60Hz



CODICE
CODE

DATI TECNICI
TECHNICAL DATA

	LUMEN	WATT	CCT (K)	CRI	OTTICA OPTIC	FINITURA FINISH
770-069CZ-21	3273	32	2700	90	17°	Bianco mat / Mat white
770-069CZ-16	3273	32	2700	90	17°	Nero / Black
770-069CX-21	3273	32	2700	90	30°	Bianco mat / Mat white
770-069CX-16	3273	32	2700	90	30°	Nero / Black
770-069CV-21	3273	32	2700	90	55°	Bianco mat / Mat white
770-069CV-16	3273	32	2700	90	55°	Nero / Black
770-069CT-21	3273	32	2700	90	70°	Bianco mat / Mat white
770-069CT-16	3273	32	2700	90	70°	Nero / Black
770-069BZ-21	3409	32	3000	90	17°	Bianco mat / Mat white
770-069BZ-16	3409	32	3000	90	17°	Nero / Black
770-069BX-21	3409	32	3000	90	30°	Bianco mat / Mat white
770-069BX-16	3409	32	3000	90	30°	Nero / Black
770-069BV-21	3409	32	3000	90	55°	Bianco mat / Mat white
770-069BV-16	3409	32	3000	90	55°	Nero / Black
770-069BT-21	3409	32	3000	90	70°	Bianco mat / Mat white
770-069BT-16	3409	32	3000	90	70°	Nero / Black
770-069AZ-21	3852	32	4000	90	17°	Bianco mat / Mat white
770-069AZ-16	3852	32	4000	90	17°	Nero / Black
770-069AX-21	3852	32	4000	90	30°	Bianco mat / Mat white
770-069AX-16	3852	32	4000	90	30°	Nero / Black
770-069AV-21	3852	32	4000	90	55°	Bianco mat / Mat white
770-069AV-16	3852	32	4000	90	55°	Nero / Black
770-069AT-21	3852	32	4000	90	70°	Bianco mat / Mat white
770-069AT-16	3852	32	4000	90	70°	Nero / Black

OPZIONALE
OPTIONAL

CODICE
CODE

DESCRIZIONE
DESCRIPTION

28-3957-30 Cilindro antiabbagliamento
Snoot



28-3959-30 Frangiluce alveolare (da utilizzare con cod. 28-3957-30)
Honeycomb (to be used with code 28-3957-30)



PERFETTO PURO LKM

37W

Faretti a binario
Track lights



Scheda tecnica
Datasheet

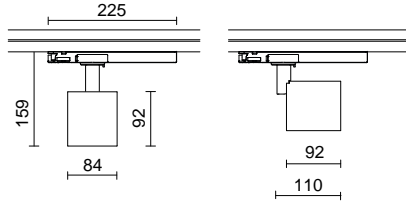

0,9 Kg

PER BINARI ELETRIFICATI TRIFASE LKM
FOR LKM THREE-PHASE ELECTRIFIED TRACKS

misure in mm / measurements in mm

Bianco mat
Mat white Nero
Black

CE $\approx 850^\circ$ IP20

220/240V - 50/60Hz



CODICE
CODE

DATI TECNICI
TECHNICAL DATA

	LUMEN	WATT	CCT (K)	CRI	OTTICA OPTIC	FINITURA FINISH
770-269CZ-21	3759	37	2700	90	17°	Bianco mat / Mat white
770-269CZ-16	3759	37	2700	90	17°	Nero / Black
770-269CX-21	3759	37	2700	90	30°	Bianco mat / Mat white
770-269CX-16	3759	37	2700	90	30°	Nero / Black
770-269CV-21	3759	37	2700	90	55°	Bianco mat / Mat white
770-269CV-16	3759	37	2700	90	55°	Nero / Black
770-269CT-21	3759	37	2700	90	70°	Bianco mat / Mat white
770-269CT-16	3759	37	2700	90	70°	Nero / Black
770-269BZ-21	3916	37	3000	90	17°	Bianco mat / Mat white
770-269BZ-16	3916	37	3000	90	17°	Nero / Black
770-269BX-21	3916	37	3000	90	30°	Bianco mat / Mat white
770-269BX-16	3916	37	3000	90	30°	Nero / Black
770-269BV-21	3916	37	3000	90	55°	Bianco mat / Mat white
770-269BV-16	3916	37	3000	90	55°	Nero / Black
770-269BT-21	3916	37	3000	90	70°	Bianco mat / Mat white
770-269BT-16	3916	37	3000	90	70°	Nero / Black
770-269AZ-21	4425	37	4000	90	17°	Bianco mat / Mat white
770-269AZ-16	4425	37	4000	90	17°	Nero / Black
770-269AX-21	4425	37	4000	90	30°	Bianco mat / Mat white
770-269AX-16	4425	37	4000	90	30°	Nero / Black
770-269AV-21	4425	37	4000	90	55°	Bianco mat / Mat white
770-269AV-16	4425	37	4000	90	55°	Nero / Black
770-269AT-21	4425	37	4000	90	70°	Bianco mat / Mat white
770-269AT-16	4425	37	4000	90	70°	Nero / Black

OPZIONALE
OPTIONAL

CODICE
CODE **DESCRIZIONE**
DESCRIPTION

28-3957-30 Cilindro antiabbagliamento
Snoot



28-3959-30 Frangiluce alveolare (da utilizzare con cod. 28-3957-30)
Honeycomb (to be used with code 28-3957-30)



PERFETTO PURO POWER LKM

53W

Faretti a binario
Track lights



Scheda tecnica
Datasheet

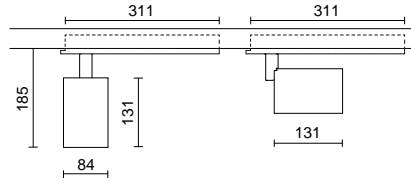

1,8 /Kg



PER BINARI ELETTRIFICATI TRIFASE LKM
FOR LKM THREE-PHASE ELECTRIFIED TRACKS

misure in mm / measurements in mm

Bianco mat
Mat white

Nero
Black

CE 850° IP20

220/240V - 50/60Hz

CODICE
CODE

DATI TECNICI
TECHNICAL DATA

	LUMEN	WATT	CCT (K)	CRI	OTTICA OPTIC	FINITURA FINISH
769-369CY-21	6156	53	2700	90	17°	Bianco mat / Mat white
769-369CY-16	6156	53	2700	90	17°	Nero / Black
769-369CX-21	6156	53	2700	90	30°	Bianco mat / Mat white
769-369CX-16	6156	53	2700	90	30°	Nero / Black
769-369CV-21	6156	53	2700	90	55°	Bianco mat / Mat white
769-369CV-16	6156	53	2700	90	55°	Nero / Black
769-369CT-21	6156	53	2700	90	70°	Bianco mat / Mat white
769-369CT-16	6156	53	2700	90	70°	Nero / Black
769-369BY-21	6412	53	3000	90	17°	Bianco mat / Mat white
769-369BY-16	6412	53	3000	90	17°	Nero / Black
769-369BX-21	6412	53	3000	90	30°	Bianco mat / Mat white
769-369BX-16	6412	53	3000	90	30°	Nero / Black
769-369BV-21	6412	53	3000	90	55°	Bianco mat / Mat white
769-369BV-16	6412	53	3000	90	55°	Nero / Black
769-369BT-21	6412	53	3000	90	70°	Bianco mat / Mat white
769-369BT-16	6412	53	3000	90	70°	Nero / Black
769-369AY-21	7375	53	4000	90	17°	Bianco mat / Mat white
769-369AY-16	7375	53	4000	90	17°	Nero / Black
769-369AX-21	7375	53	4000	90	30°	Bianco mat / Mat white
769-369AX-16	7375	53	4000	90	30°	Nero / Black
769-369AV-21	7375	53	4000	90	55°	Bianco mat / Mat white
769-369AV-16	7375	53	4000	90	55°	Nero / Black
769-369AT-21	7375	53	4000	90	70°	Bianco mat / Mat white
769-369AT-16	7375	53	4000	90	70°	Nero / Black

PERFETTO PURO LKM

ZOOM 16° to 45° - multipower 13W to 29W

Faretti a binario
Track lights



Scheda tecnica
Datasheet

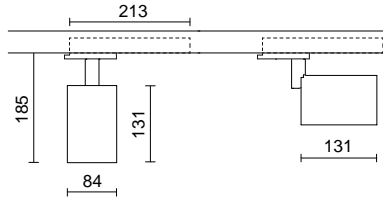

0,9 Kg

PER BINARI ELETTRIFICATI TRIFASE LKM
FOR LKM THREE-PHASE ELECTRIFIED TRACKS

misure in mm / measurements in mm

□ Bianco mat
Mat white

■ Nero
Black

CE 850° IP20

220/240V - 50/60Hz



CODICE
CODE

DATI TECNICI
TECHNICAL DATA

	LUMEN *	WATT	CCT (K)	CRI	OTTICA OPTIC	FINITURA FINISH
709-369C-21	2645	29	2700	90	16° to 45°	Bianco mat / Mat white
709-369C-16	2645	29	2700	90	16° to 45°	Nero / Black
709-369B-21	3030	29	3000	90	16° to 45°	Bianco mat / Mat white
709-369B-16	3030	29	3000	90	16° to 45°	Nero / Black
709-369A-21	3047	29	4000	90	16° to 45°	Bianco mat / Mat white
709-369A-16	3047	29	4000	90	16° to 45°	Nero / Black

* Valore riferito al massimo wattaggio / Value referring to max power

Zoom technology

La rotazione del cilindro interno permette di modificare l'angolo del fascio da 16° a 45°.

The rotation of the internal snoot modifies the beam angle from 16° to 45°.

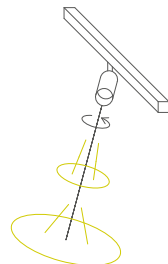

beam / fascio
16° → 45°

DIP SWITCH

Il gruppo di interruttori permette di selezionare step di wattaggi diversi (13-15-17-19-21-23-25-27-29W)

The group of switches allows the selection of different steps of wattage (13-15-17-19-21-23-25-27-29W)

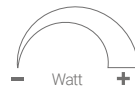

DRIM LKM

MAX. 100W

Faretti a binario
Track lights



Scheda tecnica
Datasheet

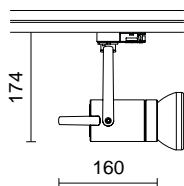

0,5 Kg

PER BINARI ELETTTRIFICATI TRIFASE LKM
FOR LKM THREE-PHASE ELECTRIFIED TRACKS

misure in mm / measurements in mm

Bianco mat
Mat white

Nero
Black

Metal
Silver

CE 850° IP20



CODICE CODE

DATI TECNICI TECHNICAL DATA

	LAMPADA LAMP	WATT	ATTACCO BASE	FINITURA FINISH
738-0163-21	IPAR30	Max. 100	E27	Bianco mat / Mat white
738-0163-16	IPAR30	Max. 100	E27	Nero / Black
738-0163-52	IPAR30	Max. 100	E27	Metal / Silver

PERFETTO COMPACT DKM

DALI - 26W

Faretti a binario
Track lights



Scheda tecnica
Datasheet

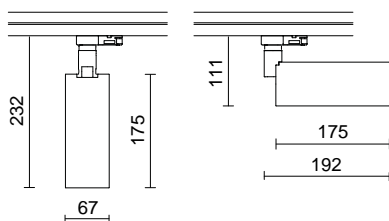

1,0 Kg

PER BINARI DIMMERABILI DKM CON APPOSITO ADATTATORE
FOR DKM DIMMABLE TRACKS WITH PROPER ADAPTER

misure in mm / measurements in mm

Bianco mat
Mat white

Nero
Black

CE IP20

220/240V - 50/60Hz



CODICE
CODE

DATI TECNICI
TECHNICAL DATA

	LUMEN	WATT	CCT (K)	CRI	OTTICA OPTIC	FINITURA FINISH
751-261CYDD-21	2187	26	2700	85	20°	Bianco mat / Mat white
751-261CYDD-16	2187	26	2700	85	20°	Nero / Black
751-261CXDD-21	2187	26	2700	85	29°	Bianco mat / Mat white
751-261CXDD-16	2187	26	2700	85	29°	Nero / Black
751-261CWDD-21	2187	26	2700	85	42°	Bianco mat / Mat white
751-261CWDD-16	2187	26	2700	85	42°	Nero / Black
751-261BYDD-21	2278	26	3000	85	20°	Bianco mat / Mat white
751-261BYDD-16	2278	26	3000	85	20°	Nero / Black
751-261BXDD-21	2278	26	3000	85	29°	Bianco mat / Mat white
751-261BXDD-16	2278	26	3000	85	29°	Nero / Black
751-261BWDD-21	2278	26	3000	85	42°	Bianco mat / Mat white
751-261BWDD-16	2278	26	3000	85	42°	Nero / Black
751-261AYDD-21	2574	26	4000	85	20°	Bianco mat / Mat white
751-261AYDD-16	2574	26	4000	85	20°	Nero / Black
751-261AXDD-21	2574	26	4000	85	29°	Bianco mat / Mat white
751-261AXDD-16	2574	26	4000	85	29°	Nero / Black
751-261AWDD-21	2574	26	4000	85	42°	Bianco mat / Mat white
751-261AWDD-16	2574	26	4000	85	42°	Nero / Black

OPZIONALE
OPTIONAL

CODICE CODE	DESCRIZIONE DESCRIPTION		CODICE CODE	DESCRIZIONE DESCRIPTION	
28-9004-30	Cilindro antiabbagliamento Snoot		14769	Adattatore per plafone Ceiling adapter	
28-4080-30	Frangiluce alveolare (da utilizzare con cod. 28-9004-30) Honeycomb (to be used with code 28-9004-30)		14768	Adattatore per cartongesso da utilizzare con cod. 14769 Adapter for plasterboard to be used with code 14769	
28-3905-47	Schermo di chiusura in termoplastico trasparente Closing screen in clear thermoplastic material				



PERFETTO PURO DKM

32W DALI

Faretti a binario
Track lights

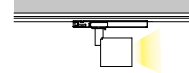

Scheda tecnica
Datasheet

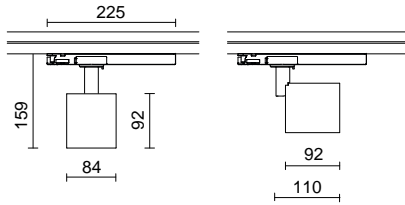

0,9 Kg

PER BINARI DIMMERABILI DKM CON APPPOSITO ADATTATORE
FOR DKM DIMMABLE TRACKS WITH PROPER ADAPTER

misure in mm / measurements in mm

Bianco mat
Mat white

Nero
Black

CE $\approx 850^\circ$ IP20

220/240V - 50/60Hz



CODICE
CODE

DATI TECNICI
TECHNICAL DATA

	LUMEN	WATT	CCT (K)	CRI	OTTICA OPTIC	FINITURA FINISH
771-069CZ-21	3273	32	2700	90	17°	Bianco mat / Mat white
771-069CZ-16	3273	32	2700	90	17°	Nero / Black
771-069CX-21	3273	32	2700	90	30°	Bianco mat / Mat white
771-069CX-16	3273	32	2700	90	30°	Nero / Black
771-069CV-21	3273	32	2700	90	55°	Bianco mat / Mat white
771-069CV-16	3273	32	2700	90	55°	Nero / Black
771-069CT-21	3273	32	2700	90	70°	Bianco mat / Mat white
771-069CT-16	3273	32	2700	90	70°	Nero / Black
771-069BZ-21	3409	32	3000	90	17°	Bianco mat / Mat white
771-069BZ-16	3409	32	3000	90	17°	Nero / Black
771-069BX-21	3409	32	3000	90	30°	Bianco mat / Mat white
771-069BX-16	3409	32	3000	90	30°	Nero / Black
771-069BV-21	3409	32	3000	90	55°	Bianco mat / Mat white
771-069BV-16	3409	32	3000	90	55°	Nero / Black
771-069BT-21	3409	32	3000	90	70°	Bianco mat / Mat white
771-069BT-16	3409	32	3000	90	70°	Nero / Black
771-069AZ-21	3852	32	4000	90	17°	Bianco mat / Mat white
771-069AZ-16	3852	32	4000	90	17°	Nero / Black
771-069AX-21	3852	32	4000	90	30°	Bianco mat / Mat white
771-069AX-16	3852	32	4000	90	30°	Nero / Black
771-069AV-21	3852	32	4000	90	55°	Bianco mat / Mat white
771-069AV-16	3852	32	4000	90	55°	Nero / Black
771-069AT-21	3852	32	4000	90	70°	Bianco mat / Mat white
771-069AT-16	3852	32	4000	90	70°	Nero / Black

OPZIONALE
OPTIONAL

CODICE
CODE

DESCRIZIONE
DESCRIPTION

28-3957-30 Cilindro antiabbagliamento
Snoot



28-3959-30 Frangiluce alveolare (da utilizzare con cod. 28-3957-30)
Honeycomb (to be used with code 28-3957-30)



PERFETTO PURO DKM

37W DALI

Faretti a binario
Track lights



Scheda tecnica
Datasheet

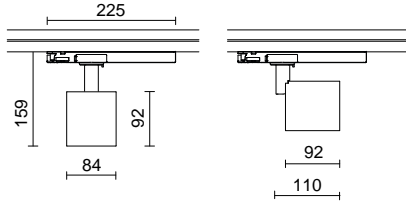

0,9 Kg

PER BINARI DIMMERABILI DKM CON APPOSITO ADATTATORE
FOR DKM DIMMABLE TRACKS WITH PROPER ADAPTER

misure in mm / measurements in mm

Bianco mat
Mat white

Nero
Black

CE 850° IP20

220/240V - 50/60Hz



CODICE
CODE

DATI TECNICI
TECHNICAL DATA

	LUMEN	WATT	CCT (K)	CRI	OTTICA OPTIC	FINITURA FINISH
771-269CZ-21	3759	37	2700	90	17°	Bianco mat / Mat white
771-269CZ-16	3759	37	2700	90	17°	Nero / Black
771-269CX-21	3759	37	2700	90	30°	Bianco mat / Mat white
771-269CX-16	3759	37	2700	90	30°	Nero / Black
771-269CV-21	3759	37	2700	90	55°	Bianco mat / Mat white
771-269CV-16	3759	37	2700	90	55°	Nero / Black
771-269CT-21	3759	37	2700	90	70°	Bianco mat / Mat white
771-269CT-16	3759	37	2700	90	70°	Nero / Black
771-269BZ-21	3916	37	3000	90	17°	Bianco mat / Mat white
771-269BZ-16	3916	37	3000	90	17°	Nero / Black
771-269BX-21	3916	37	3000	90	30°	Bianco mat / Mat white
771-269BX-16	3916	37	3000	90	30°	Nero / Black
771-269BV-21	3916	37	3000	90	55°	Bianco mat / Mat white
771-269BV-16	3916	37	3000	90	55°	Nero / Black
771-269BT-21	3916	37	3000	90	70°	Bianco mat / Mat white
771-269BT-16	3916	37	3000	90	70°	Nero / Black
771-269AZ-21	4425	37	4000	90	17°	Bianco mat / Mat white
771-269AZ-16	4425	37	4000	90	17°	Nero / Black
771-269AX-21	4425	37	4000	90	30°	Bianco mat / Mat white
771-269AX-16	4425	37	4000	90	30°	Nero / Black
771-269AV-21	4425	37	4000	90	55°	Bianco mat / Mat white
771-269AV-16	4425	37	4000	90	55°	Nero / Black
771-269AT-21	4425	37	4000	90	70°	Bianco mat / Mat white
771-269AT-16	4425	37	4000	90	70°	Nero / Black

OPZIONALE
OPTIONAL

CODICE
CODE

DESCRIZIONE
DESCRIPTION

28-3957-30 Cilindro antiabbagliamento
Snoot



28-3959-30 Frangiluce alveolare (da utilizzare con cod. 28-3957-30)
Honeycomb (to be used with code 28-3957-30)



3546 TRACK



Scheda tecnica
Datasheet

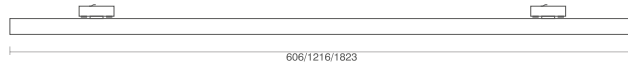

misure in mm / measurements in mm

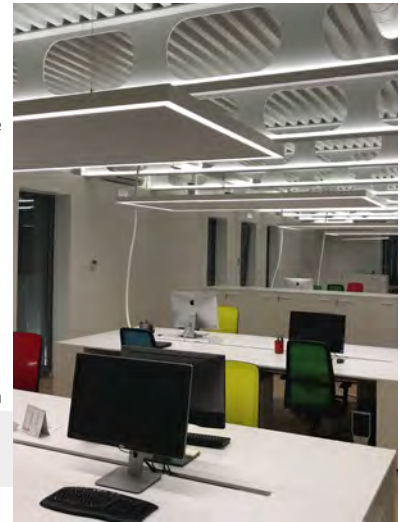

Configuratore di riferimento:
Reference configurator:

Es: 3546B-Z002L18

Alluminio anodizzato
Anodized aluminum
 Bianco
White
 Nero
Black

IP20

COMPOSIZIONE CODICE CODE COMPOSITION:

COD.BASE BASE CODE:	COLORE LED LED COLOR	DIFFUSORE DIFFUSER	FINITURA FINISH	LUNGHEZZA LENGTH
3546B-	Z (bianco 2700K/white 2700K)	O (opale/opal)	00 (alluminio/alluminium)	L06 (606mm)
	C (bianco caldo/warm white)	*P (prismatizzato UGR<19 prismatic UGR<19)	01 (bianco/white)	L12 (1216mm)
	N (bianco neutro/neutral white)		02 (nero/black)	L18 (1823mm)

DATI TECNICI TECHNICAL DATA

LUMEN (4000K)	WATT	CRI
1440	11W	90
2880	22,5W	90
4320	34W	90

COMPATIBILE COMPATIBLE

CODICE CODE	DESCRIZIONE DESCRIPTION
Binario LKM trifase quadrato / LKM 3-phase square track	
7511-20-31	Lunghezza 1000mm bianco/ LENGTH 1000mm white
7511-40-31	Lunghezza 2000mm bianco/ LENGTH 2000mm white
7511-20-30	Lunghezza 1000mm nero/ LENGTH 1000mm black
7511-40-30	Lunghezza 2000mm nero/ LENGTH 2000mm black
Binario LKM trifase da incasso / LKM 3-phase recessed track	
7512-20-31	Lunghezza 1000mm bianco / LENGTH 1000mm white
7512-40-31	Lunghezza 2000mm bianco/ LENGTH 2000mm white
7512-20-30	Lunghezza 1000mm nero/ LENGTH 1000mm black
7512-40-30	Lunghezza 2000mm nero/ LENGTH 2000mm black



MICROPERFETTO 48V_{DC}

18W PWM

Faretti a binario
Track lights



Scheda tecnica
Datasheet

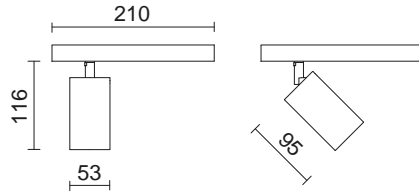

0,4 Kg

PER BINARI ELETTRIFICATI A BASSA TENSIONE 48V
FOR 48V LOW-VOLTAGE ELECTRIFIED TRACKS

misure in mm / measurements in mm

Bianco mat
Mat white

Nero
Black

CE 850° IP20

48V



CODICE
CODE

DATI TECNICI
TECHNICAL DATA

	LUMEN	WATT	CCT (K)	CRI	OTTICA OPTIC	FINITURA FINISH
754-289CX-21	1362	18	2700	90	30°	Bianco mat / Mat white
754-289CX-16	1362	18	2700	90	30°	Nero / Black
754-289CV-21	1362	18	2700	90	45°	Bianco mat / Mat white
754-289CV-16	1362	18	2700	90	45°	Nero / Black
754-289BX-21	1436	18	3000	90	30°	Bianco mat / Mat white
754-289BX-16	1436	18	3000	90	30°	Nero / Black
754-289BV-21	1436	18	3000	90	45°	Bianco mat / Mat white
754-289BV-16	1436	18	3000	90	45°	Nero / Black
754-289AX-21	1623	18	4000	90	30°	Bianco mat / Mat white
754-289AX-16	1623	18	4000	90	30°	Nero / Black
754-289AV-21	1623	18	4000	90	45°	Bianco mat / Mat white
754-289AV-16	1623	18	4000	90	45°	Nero / Black

Trasformatore elettronico per uso remoto e dimmer PWM dedicato
da ordinare separatamente / Electronic transformer for remote use
and proper PWM dimmer, to be ordered separately

OPZIONALE
OPTIONAL

CODICE CODE	DESCRIZIONE DESCRIPTION
28-4139-100	Cilindro oro satinato Satinated gold baffle
28-4139-31	Cilindro bianco White baffle
28-4163-30	Frangiluce alveolare Honeycomb



CODICE CODE	DESCRIZIONE DESCRIPTION
28-4073-61	Vetro sabbiato Frosted glass
28-4073-103	Vetro ellittico Elliptical spread lens



MICROPERFETTO 48V_{DC}

21W PWM

Faretti a binario
Track lights

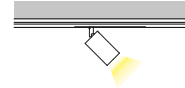

Scheda tecnica
Datasheet

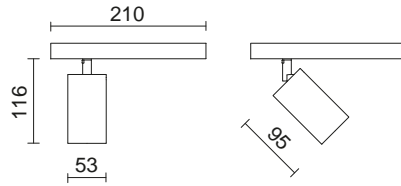

0,4 Kg

PER BINARI ELETTRIFICATI A BASSA TENSIONE 48V
FOR 48V LOW-VOLTAGE ELECTRIFIED TRACKS

misure in mm / measurements in mm

Bianco mat
Mat white

Nero
Black

CE 850° IP20

48V



CODICE
CODE

DATI TECNICI
TECHNICAL DATA

	LUMEN	WATT	CCT (K)	CRI	OTTICA OPTIC	FINITURA FINISH
754-489CX-21	1543	21	2700	90	30°	Bianco mat / Mat white
754-489CX-16	1543	21	2700	90	30°	Nero / Black
754-489CV-21	1543	21	2700	90	45°	Bianco mat / Mat white
754-489CV-16	1543	21	2700	90	45°	Nero / Black
754-489BX-21	1644	21	3000	90	30°	Bianco mat / Mat white
754-489BX-16	1644	21	3000	90	30°	Nero / Black
754-489BV-21	1644	21	3000	90	45°	Bianco mat / Mat white
754-489BV-16	1644	21	3000	90	45°	Nero / Black
754-489AX-21	1777	21	4000	90	30°	Bianco mat / Mat white
754-489AX-16	1777	21	4000	90	30°	Nero / Black
754-489AV-21	1777	21	4000	90	45°	Bianco mat / Mat white
754-489AV-16	1777	21	4000	90	45°	Nero / Black

Trasformatore elettronico per uso remoto e dimmer PWM dedicato
da ordinare separatamente / Electronic transformer for remote use
and proper PWM dimmer, to be ordered separately

OPZIONALE
OPTIONAL

CODICE CODE	DESCRIZIONE DESCRIPTION	CODICE CODE	DESCRIZIONE DESCRIPTION
28-4139-100	Cilindro oro satinato Satinated gold baffle	28-4073-61	Vetro sabbaiato Frosted glass
28-4139-31	Cilindro bianco White baffle	28-4073-103	Vetro ellittico Elliptical spread lens
28-4163-30	Frangiluce alveolare Honeycomb		

MICROPERFETTO 48V_{DC}

26W PWM

Faretti a binario
Track lights



Scheda tecnica
Datasheet

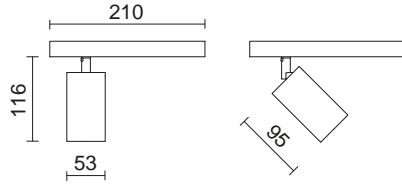

0,4 Kg

PER BINARI ELETTRIFICATI A BASSA TENSIONE 48V
FOR 48V LOW-VOLTAGE ELECTRIFIED TRACKS

misure in mm / measurements in mm

Bianco mat
Mat white

Nero
Black

CE 850° IP20

48V



CODICE
CODE

DATI TECNICI
TECHNICAL DATA

	LUMEN	WATT	CCT (K)	CRI	OTTICA OPTIC	FINITURA FINISH
754-789CX-21	1813	26	2700	90	30°	Bianco mat / Mat white
754-789CX-16	1813	26	2700	90	30°	Nero / Black
754-789CV-21	1813	26	2700	90	45°	Bianco mat / Mat white
754-789CV-16	1813	26	2700	90	45°	Nero / Black
754-789BX-21	1890	26	3000	90	30°	Bianco mat / Mat white
754-789BX-16	1890	26	3000	90	30°	Nero / Black
754-789BV-21	1890	26	3000	90	45°	Bianco mat / Mat white
754-789BV-16	1890	26	3000	90	45°	Nero / Black
754-789AX-21	1918	26	4000	90	30°	Bianco mat / Mat white
754-789AX-16	1918	26	4000	90	30°	Nero / Black
754-789AV-21	1918	26	4000	90	45°	Bianco mat / Mat white
754-789AV-16	1918	26	4000	90	45°	Nero / Black

Trasformatore elettronico per uso remoto e dimmer PWM dedicato
da ordinare separatamente / Electronic transformer for remote use
and proper PWM dimmer, to be ordered separately

OPZIONALE
OPTIONAL

CODICE CODE	DESCRIZIONE DESCRIPTION
28-4139-100	Cilindro oro satinato Satinated gold baffle
28-4139-31	Cilindro bianco White baffle
28-4163-30	Frangiluce alveolare Honeycomb



CODICE CODE	DESCRIZIONE DESCRIPTION
28-4073-61	Vetro sabbiato Frosted glass
28-4073-103	Vetro ellittico Elliptical spread lens



MICROPERFETTO 48V_{DC}

21W DALI

Faretti a binario
Track lights



Scheda tecnica
Datasheet

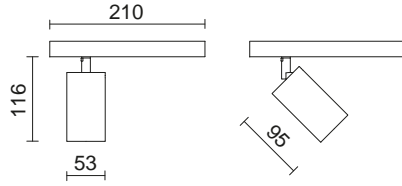

0,4 Kg

PER BINARI ELETTRIFICATI A BASSA TENSIONE 48V
FOR 48V LOW-VOLTAGE ELECTRIFIED TRACKS

misure in mm / measurements in mm

□ Bianco mat / Mat white
■ Nero / Black

CE 850° IP20

48V



CODICE
CODE

DATI TECNICI
TECHNICAL DATA

	LUMEN	WATT	CCT (K)	CRI	OTTICA OPTIC	FINITURA FINISH
754-589CX-21	1543	21	2700	90	30°	Bianco mat / Mat white
754-589CX-16	1543	21	2700	90	30°	Nero / Black
754-589CV-21	1543	21	2700	90	45°	Bianco mat / Mat white
754-589CV-16	1543	21	2700	90	45°	Nero / Black
754-589BX-21	1644	21	3000	90	30°	Bianco mat / Mat white
754-589BX-16	1644	21	3000	90	30°	Nero / Black
754-589BV-21	1644	21	3000	90	45°	Bianco mat / Mat white
754-589BV-16	1644	21	3000	90	45°	Nero / Black
754-589AX-21	1777	21	4000	90	30°	Bianco mat / Mat white
754-589AX-16	1777	21	4000	90	30°	Nero / Black
754-589AV-21	1777	21	4000	90	45°	Bianco mat / Mat white
754-589AV-16	1777	21	4000	90	45°	Nero / Black

Trasformatore elettronico per uso remoto e dimmer PWM dedicato
da ordinare separatamente / Electronic transformer for remote use
and proper PWM dimmer, to be ordered separately

OPZIONALE
OPTIONAL

CODICE CODE	DESCRIZIONE DESCRIPTION
28-4139-100	Cilindro oro satinato Satinated gold baffle
28-4139-31	Cilindro bianco White baffle
28-4163-30	Frangiluce alveolare Honeycomb



CODICE CODE	DESCRIZIONE DESCRIPTION
28-4073-61	Vetro sabbiato Frosted glass
28-4073-103	Vetro ellittico Elliptical spread lens



MICROPERFETTO 48V_{DC}

26W DALI

Faretti a binario
Track lights



Scheda tecnica
Datasheet

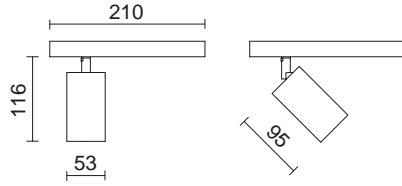

0,4 Kg

PER BINARI ELETTTRIFICATI A BASSA TENSIONE 48V
FOR 48V LOW-VOLTAGE ELECTRIFIED TRACKS

misure in mm / measurements in mm

Bianco mat
Mat white

Nero
Black

CE 850° IP20

48V



CODICE
CODE

DATI TECNICI
TECHNICAL DATA

	LUMEN	WATT	CCT (K)	CRI	OTTICA OPTIC	FINITURA FINISH
754-889CX-21	1813	26	2700	90	30°	Bianco mat / Mat white
754-889CX-16	1813	26	2700	90	30°	Nero / Black
754-889CV-21	1813	26	2700	90	45°	Bianco mat / Mat white
754-889CV-16	1813	26	2700	90	45°	Nero / Black
754-889BX-21	1890	26	3000	90	30°	Bianco mat / Mat white
754-889BX-16	1890	26	3000	90	30°	Nero / Black
754-889BV-21	1890	26	3000	90	45°	Bianco mat / Mat white
754-889BV-16	1890	26	3000	90	45°	Nero / Black
754-889AX-21	1918	26	4000	90	30°	Bianco mat / Mat white
754-889AX-16	1918	26	4000	90	30°	Nero / Black
754-889AV-21	1918	26	4000	90	45°	Bianco mat / Mat white
754-889AV-16	1918	26	4000	90	45°	Nero / Black

Trasformatore elettronico per uso remoto e dimmer DALI dedicato
da ordinare separatamente / Electronic transformer for remote use
and proper DALI dimmer, to be ordered separately

OPZIONALE
OPTIONAL

CODICE CODE	DESCRIZIONE DESCRIPTION
28-4139-100	Cilindro oro satinato Satinated gold baffle
28-4139-31	Cilindro bianco White baffle
28-4163-30	Frangiluce alveolare Honeycomb



CODICE CODE	DESCRIZIONE DESCRIPTION
28-4073-61	Vetro sabbiato Frosted glass
28-4073-103	Vetro ellittico Elliptical spread lens



MICROPERFETTO 48V_{DC}

DIM TO WARM

Faretti a binario
Track lights



Scheda tecnica
Datasheet

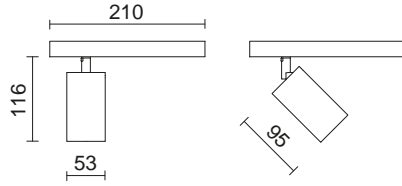

0,4 Kg

PER BINARI ELETTRIFICATI A BASSA TENSIONE 48V
FOR 48V LOW-VOLTAGE ELECTRIFIED TRACKS

misure in mm / measurements in mm

Bianco mat
Mat white

Nero
Black

CE 850° IP20

48V



CODICE
CODE

DATI TECNICI
TECHNICAL DATA

CODICE CODE	LUMEN	WATT	CCT (K)	CRI	OTTICA OPTIC	FINITURA FINISH
754-689MX-21	791*	12	1800-2700	90	30°	Bianco mat / Mat white
754-689MX-16	791*	12	1800-2700	90	30°	Nero / Black

Trasformatore elettronico per uso remoto e dimmer DALI dedicato da ordinare separatamente.
La tecnologia Dim to Warm consente di regolare la temperatura colore da 2700K a 1800K.
* Valore riferito alla massima dimmerazione.

Electronic transformer for remote use and proper DALI dimmer, to be ordered separately.
The Dim to Warm technology allows the control of colour temperature from 2700K to 1800K.
* Value referring to max dimming.

OPZIONALE
OPTIONAL

CODICE CODE	DESCRIZIONE DESCRIPTION
28-4139-100	Cilindro oro satinato Satinated gold baffle
28-4139-31	Cilindro bianco White baffle
28-4163-30	Frangiluce alveolare Honeycomb



CODICE CODE	DESCRIZIONE DESCRIPTION
28-4073-61	Vetro sabbato Frosted glass
28-4073-103	Vetro ellittico Elliptical spread lens



Faretti da incasso

Downlights



I LED driver devono essere ordinati separatamente.
La potenza dell'apparecchio varia a seconda del driver scelto.

LED drivers should be ordered separately.
The wattage of the fittings changes, depending on the selected driver.



Luce essenziale

Essential light

Gli incassi diffondono luce generale o d'accento, ma sempre ad alto rendimento luminoso. Esprimono valori di luminanza contenuti e livelli di abbagliamento estremamente bassi, grazie alle ottiche arretrate e a un'ampia gamma di accessori. Sono disponibili numerose varianti: con cornice tonda o quadra, con ottica fissa oppure oscillante, senza cornice e con profondità di incasso ridotte.



The downlights spread general or accent light, keeping high luminous efficiency. The low luminance is combined with extremely low glare levels, thanks to the recessed optics and a wide range of accessories.

You can choose among many versions: with round or square bezel, with a fixed or tiltable optic, trimless or with low recessed height.

NARY 30

Incasso fisso
Fixed Recessed



Scheda tecnica
Datasheet

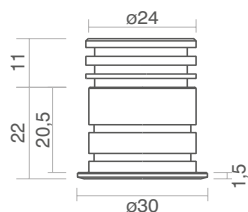

IP20

350 mA

25 mm

ALIMENTATORE NON INCLUSO
DRIVER NOT INCLUDED
misure in mm / measurements in mm

Alluminio
Aluminum

CE IP20



Configuratore di riferimento:
Reference configurator:

Es: N30-C1

COMPOSIZIONE CODICE

CODE COMPOSITION

COD.BASE BASE CODE	COLORE LED LED COLOR	OTTICA OPTIC
N30-	C (bianco caldo/warm white)	1 (10°)
	N (bianco neutro/neutral white)	2 (25°)
	F (bianco freddo/cold white)	3 (ellittica/elliptical)
	B (blu/blue)	4 (40°)
	R (rosso/red)	7 (120°)
	V (verde/green)	
	H (RGB)	

DATI TECNICI

TECHNICAL DATA

LUMEN	WATT	CRI
90	1,2	80
96	1,2	80
105	1,2	80

DRIVER DA ORDINARE SEPARATAMENTE

DRIVER TO ORDER SEPARATELY

mA	PUSH	1-10V	DALI
350	03150	03150	03151

OPZIONALE

OPTIONAL

09010
CTRL CC 3CH RGB+RC 220VAC max.10W/CH

COPENAGHEN 41

Incasso fisso
Fixed Recessed



Scheda tecnica
Datasheet

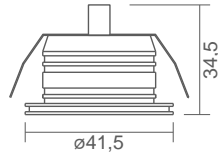

IP40

220 Vac

ø38,2

ALIMENTATORE INCLUSO 220Vac
DRIVER INCLUDED 220Vac
misure in mm / measurements in mm



Configuratore di riferimento:
Reference configurator:

Es: CPG-C

Alluminio bianco
White aluminum

OTTICA 30°
OPTICS 30°

CE IP40

COMPOSIZIONE CODICE
CODE COMPOSITION

COD.BASE **COLORE LED**
BASE CODE: LED COLOR

CPG- **C** (bianco caldo/warm white)
 N (bianco neutro/neutral white)

DATI TECNICI
TECHNICAL DATA

LUMEN	WATT	CRI
230	3	80
250	3	80

OPZIONALE
OPTIONAL

03150
DRIVER 350-900mA 20W 1.10V-PUSH IP20

03151
DRIVER 350-900mA/24VDC 20W DALI IP20

Accessori da utilizzare in applicazione remota con settaggio a 700mA (esterni al faretto)
Accessories to be used in remote application with setting at 700mA (external to the spotlight)

RA 4

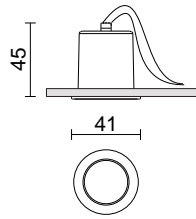

Incasso fisso
Fixed Recessed



Scheda tecnica
Datasheet

IP43

ø36

ALIMENTATORE NON INCLUSO
DRIVER NOT INCLUDED
misure in mm / measurements in mm

Bianco mat
Mat white

CE **IP43 IK07**



CODICE
CODE

DATI TECNICI
TECHNICAL DATA

	LUMEN	WATT	mA	CCT (K)	CRI	OTTICA OPTIC	FINITURA FINISH
252-200CUN-21	307	4,6	500	2700	85	60°	Bianco mat / Mat white
252-200BUN-21	320	4,6	500	3000	85	60°	Bianco mat / Mat white
252-200AUN-21	362	4,6	500	4000	85	60°	Bianco mat / Mat white

DRIVER DA ORDINARE SEPARATAMENTE - per installazione in posizione remota
DRIVER TO BE ORDERED SEPARATELY - for remote installation

mA	Constant current
500	81-04019

DRIVER DA ORDINARE SEPARATAMENTE - per installazione attraverso il foro
DRIVER TO BE ORDERED SEPARATELY - for installation through the hole

mA	Constant current	
500	81-04031	Considerare una profondità di incasso di 160mm Consider a recessed depth of 160mm

RA 7

Incasso fisso
Fixed Recessed



Scheda tecnica
Datasheet

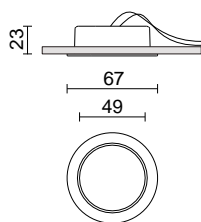

ALIMENTATORE NON INCLUSO
DRIVER NOT INCLUDED
misure in mm / measurements in mm

Bianco mat
Mat white

CE **IP43 IK07**

CODICE
CODE

DATI TECNICI
TECHNICAL DATA

	LUMEN	WATT	mA	CCT (K)	CRI	OTTICA OPTIC	FINITURA FINISH
251-200CTN-21	363	4,6	500	2700	85	110°	Bianco mat / Mat white
251-200BTN-21	378	4,6	500	3000	85	110°	Bianco mat / Mat white
251-200ATN-21	427	4,6	500	4000	85	110°	Bianco mat / Mat white

DRIVER DA ORDINARE SEPARATAMENTE - per installazione in posizione remota
DRIVER TO BE ORDERED SEPARATELY - for remote installation

mA	Constant current	
500	81-04019	Distanza max dal driver 30m Max distance from driver 30m

VIENNA 70

Incasso fisso
Fixed Recessed



Scheda tecnica
Datasheet

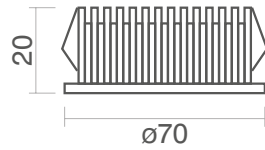

IP44

220 Vac

ø60

ALIMENTATORE INCLUSO 220Vac
DRIVER INCLUDED 220Vac
misure in mm / measurements in mm



Configuratore di riferimento:
Reference configurator:

Es: VN70-C

Alluminio bianco
White aluminum

OTTICA 90°
OPTICS 90°

CE IP44

COMPOSIZIONE CODICE
CODE COMPOSITION

COD.BASE **COLORE LED**
BASE CODE: LED COLOR

VN70- **C** (bianco caldo/warm white)
 N (bianco neutro/neutral white)

DATI TECNICI
TECHNICAL DATA

LUMEN	WATT	CRI
300	4,5	80
320	4,5	80

OPZIONALE
OPTIONAL

03150
DRIVER 350-900mA 20W 1.10V-PUSH IP20

03151
DRIVER 350-900mA/24VDC 20W DALI IP20

Accessori da utilizzare in applicazione remota con settaggio a 350mA (esterni al faretto)
Accessories to be used in remote application with setting at 350mA (external to the spotlight)

MONACO 70

Incasso fisso
Fixed Recessed



Scheda tecnica
Datasheet

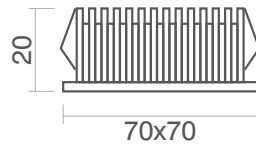

IP44

220 Vac

61x61 mm

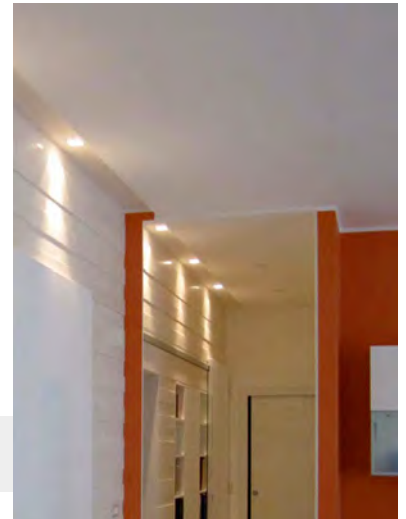

ALIMENTATORE INCLUSO 220Vac
DRIVER INCLUDED 220Vac
misure in mm / measurements in mm

Alluminio bianco
White aluminum

OTTICA 90°
OPTICS 90°

CE IP44

COMPOSIZIONE CODICE
CODE COMPOSITION

COD.BASE **COLORE LED**
BASE CODE: LED COLOR

MC70- **C** (bianco caldo/warm white)
 N (bianco neutro/neutral white)

DATI TECNICI
TECHNICAL DATA

LUMEN	WATT	CRI
300	4,5	80
320	4,5	80

Configuratore di riferimento:
Reference configurator:
Es: MC70-C

OPZIONALE
OPTIONAL

03150
DRIVER 350-900mA 20W 1.10V-PUSH IP20

03151
DRIVER 350-900mA/24VDC 20W DALI IP20

Accessori da utilizzare in applicazione remota con settaggio a 350mA (esterni al faretto)
Accessories to be used in remote application with setting at 350mA (external to the spotlight)

RA 8 DIXIT LED

Incasso fisso
Fixed Recessed



Scheda tecnica
Datasheet

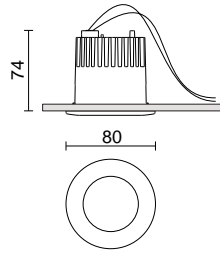

ALIMENTATORE NON INCLUSO
DRIVER NOT INCLUDED
misure in mm / measurements in mm

Bianco mat
Mat white

CE **IP43 IK08**

CODICE CODE	DATI TECNICI TECHNICAL DATA						
	LUMEN	WATT	mA	CCT (K)	CRI	OTTICA OPTIC	FINITURA FINISH
238-250CN-21	1122	9	250	2700	80	26°	Bianco mat / Mat white
	1538	12	350	2700	80	26°	Bianco mat / Mat white
238-250BN-21	1169	9	250	3000	80	26°	Bianco mat / Mat white
	1602	12	350	3000	80	26°	Bianco mat / Mat white
238-250AN-21	1183	9	250	4000	80	26°	Bianco mat / Mat white
	1622	12	350	4000	80	26°	Bianco mat / Mat white

DRIVER DA ORDINARE SEPARATAMENTE DRIVER TO ORDER SEPARATELY

mA	On / Off	MAINS DIMM.	DALI/PUSH
250	81-04009	-	81-04042
350	-	81-04010	81-04003

OPZIONALE OPTIONAL

CODICE CODE	DESCRIZIONE DESCRIPTION
28-3868-51	Ottica professionale W - fascio 45° Professional optic device W - beam 45°
28-3868-31	Ottica professionale XW - fascio 65° Professional optic device XW - beam 65°



Ottiche non pre-montate
Not pre-assembled optics

RA 8 L DIXIT LED

Incasso fisso
Fixed Recessed



Scheda tecnica
Datasheet

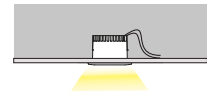



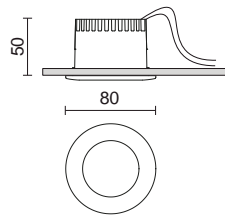

IP43 
ø70 

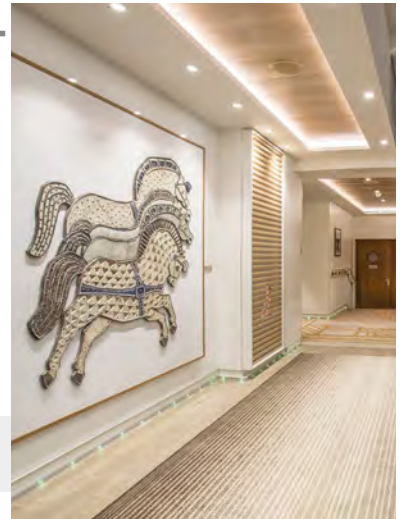

ALIMENTATORE NON INCLUSO
DRIVER NOT INCLUDED
misure in mm / measurements in mm



Bianco mat
Mat white

CE     850° **IP43 IK08**

CODICE
CODE

DATI TECNICI
TECHNICAL DATA

	LUMEN	WATT	mA	CCT (K)	CRI	OTTICA OPTIC	FINITURA FINISH
238-239CN-21	427	5,5	350	2700	90	26°	Bianco mat / Mat white
	612	8,5	500	2700	90	26°	Bianco mat / Mat white
238-239BN-21	501	5,5	350	3000	90	26°	Bianco mat / Mat white
	638	8,5	500	3000	90	26°	Bianco mat / Mat white
238-239AN-21	610	5,5	350	4000	90	26°	Bianco mat / Mat white
	683	8,5	500	4000	90	26°	Bianco mat / Mat white

DRIVER DA ORDINARE SEPARATEMENTE
DRIVER TO ORDER SEPARATELY

mA	On / Off	1-10V	DALI/PUSH
350	-	81-04007	81-04003
500	-	81-04008	81-04002

OPZIONALE
OPTIONAL

CODICE CODE	DESCRIZIONE DESCRIPTION
28-3868-51	Ottica professionale W - fascio 45° Professional optic device W - beam 45°
28-3868-31	Ottica professionale XW - fascio 65° Professional optic device XW - beam 65°



Ottiche non pre-montate
Not pre-assembled optics

RA 8 Q DIXIT LED

Incasso fisso
Fixed Recessed



Scheda tecnica
Datasheet

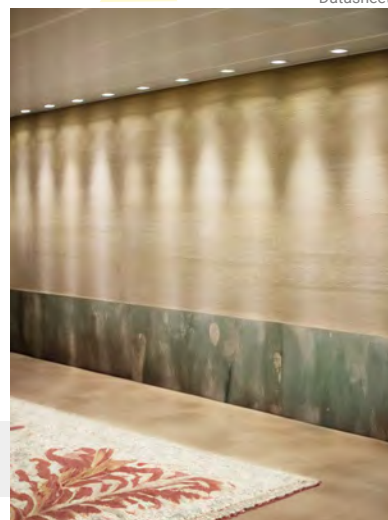
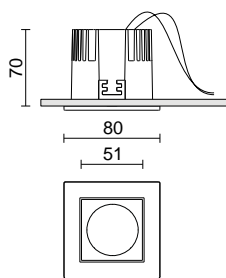

ALIMENTATORE NON INCLUSO
DRIVER NOT INCLUDED
misure in mm / measurements in mm

Bianco mat
Mat white

CE 850° IP43 IK08

CODICE
CODE

DATI TECNICI
TECHNICAL DATA

	LUMEN	WATT	mA	CCT (K)	CRI	OTTICA OPTIC	FINITURA FINISH
233-250CN-21	1122	9	250	2700	80	26°	Bianco mat / Mat white
	1538	12	350	2700	80	26°	Bianco mat / Mat white
233-250BN-21	1169	9	250	3000	80	26°	Bianco mat / Mat white
	1602	12	350	3000	80	26°	Bianco mat / Mat white
233-250AN-21	1321	9	250	4000	80	26°	Bianco mat / Mat white
	1810	12	350	4000	80	26°	Bianco mat / Mat white

DRIVER DA ORDINARE SEPARATAMENTE
DRIVER TO ORDER SEPARATELY

mA	On / Off	MAINS DIMM.	DALI/PUSH
250	81-04009	-	81-04042
350	-	81-04010	81-04003

OPZIONALE
OPTIONAL

CODICE CODE	DESCRIZIONE DESCRIPTION
28-3903-51	Ottica professionale W - fascio 45° Professional optic device W - beam 45°
28-3903-31	Ottica professionale XW - fascio 65° Professional optic device XW - beam 65°



Ottiche non pre-montate
Not pre-assembled optics



RA 8 L TL DIXIT LED

Incasso fisso
Fixed Recessed



Scheda tecnica
Datasheet

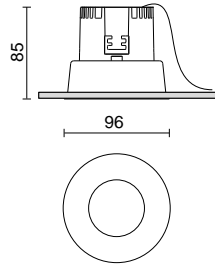

ALIMENTATORE NON INCLUSO
DRIVER NOT INCLUDED
misure in mm / measurements in mm

Bianco mat
Mat white

CE **IP43 IK08**

CODICE
CODE

DATI TECNICI
TECHNICAL DATA

	LUMEN	WATT	mA	CCT (K)	CRI	OTTICA OPTIC	FINITURA FINISH
234-239CN-21	427	5,5	350	2700	90	26°	Bianco mat / Mat white
	612	8,5	500	2700	90	26°	Bianco mat / Mat white
234-239BN-21	501	5,5	350	3000	90	26°	Bianco mat / Mat white
	638	8,5	500	3000	90	26°	Bianco mat / Mat white
234-239AN-21	610	5,5	350	4000	90	26°	Bianco mat / Mat white
	683	8,5	500	4000	90	26°	Bianco mat / Mat white

DRIVER DA ORDINARE SEPARATAMENTE
DRIVER TO ORDER SEPARATELY

mA	On / Off	MAINS DIMM.	DALI/PUSH
350	-	81-04007	81-04003
500	-	81-04008	81-04002

OPZIONALE
OPTIONAL

CODICE CODE	DESCRIZIONE DESCRIPTION
28-3868-51	Ottica professionale W - fascio 45° Professional optic device W - beam 45°
28-3868-31	Ottica professionale XW - fascio 65° Professional optic device XW - beam 65°

Ottiche non pre-montate
Not pre-assembled optics



RA 8 TL DIXIT LED

Incasso fisso
Fixed Recessed



Scheda tecnica
Datasheet

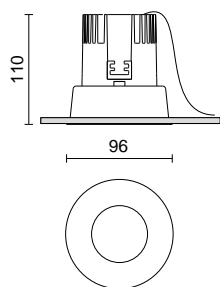

ALIMENTATORE NON INCLUSO
DRIVER NOT INCLUDED
misure in mm / measurements in mm

Bianco mat
Mat white

CE 850° **IP43 IK08**

CODICE
CODE

DATI TECNICI
TECHNICAL DATA

	LUMEN	WATT	mA	CCT (K)	CRI	OTTICA OPTIC	FINITURA FINISH
234-259CN-21	884	9	250	2700	90	26°	Bianco mat / Mat white
	1179	12	350	2700	90	26°	Bianco mat / Mat white
234-259BN-21	921	9	250	3000	90	26°	Bianco mat / Mat white
	1228	12	350	3000	90	26°	Bianco mat / Mat white
234-259AN-21	1041	9	250	4000	90	26°	Bianco mat / Mat white
	1388	12	350	4000	90	26°	Bianco mat / Mat white

DRIVER DA ORDINARE SEPARATAMENTE
DRIVER TO ORDER SEPARATELY

mA	On / Off	MAINS DIMM.	DALI/PUSH
250	81-04009	-	81-04042
350	-	81-04010	81-04003

OPZIONALE
OPTIONAL

CODICE CODE	DESCRIZIONE DESCRIPTION
28-3868-51	Ottica professionale W - fascio 45° Professional optic device W - beam 45°
28-3868-31	Ottica professionale XW - fascio 65° Professional optic device XW - beam 65°



Ottiche non pre-montate
Not pre-assembled optics

RA 11 DIXIT LED

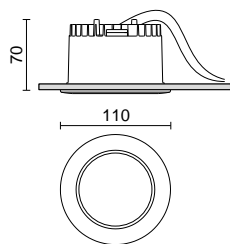

Incasso fisso
Fixed Recessed



Scheda tecnica
Datasheet



ALIMENTATORE NON INCLUSO
DRIVER NOT INCLUDED
misure in mm / measurements in mm

Bianco mat
Mat white

CE 850° **IP43 IK08**

CODICE
CODE

DATI TECNICI
TECHNICAL DATA

	LUMEN	WATT	mA	CCT (K)	CRI	OTTICA OPTIC	FINITURA FINISH
255-200CN-21	1452	12	350	2700	85	55°	Bianco mat / Mat white
	2008	18	500	2700	85	55°	Bianco mat / Mat white
	2649	26	700	2700	85	55°	Bianco mat / Mat white
255-200BN-21	1513	12	350	3000	85	55°	Bianco mat / Mat white
	2092	18	500	3000	85	55°	Bianco mat / Mat white
	2759	26	700	3000	85	55°	Bianco mat / Mat white
255-200AN-21	1602	12	350	4000	85	55°	Bianco mat / Mat white
	2180	18	500	4000	85	55°	Bianco mat / Mat white
	2848	26	700	4000	85	55°	Bianco mat / Mat white

DRIVER DA ORDINARE SEPARATAMENTE
DRIVER TO ORDER SEPARATELY

mA	On / Off	MAINS DIMM.	1-10V	DALI/PUSH
350	-	81-04010	-	81-04003
500	81-04011	-	-	81-04002
700	81-04012	81-04044	81-04066	81-02413

OPZIONALE
OPTIONAL

CODICE CODE	DESCRIZIONE DESCRIPTION	CODICE CODE	DESCRIZIONE DESCRIPTION
28-3140-51	Ottica professionale S - fascio 18° Professional optic device S - beam 18°	28-4019-30	Frangiluce alveolare Honeycomb
28-3142-51	Ottica professionale M - fascio 30° Professional optic device M - beam 30°		
28-3141-31	Ottica professionale XW - fascio 70° Professional optic device XW - beam 70°		

Ottiche non pre-montate
Not pre-assembled optics

RA 11 Q DIXIT LED

Incasso fisso
Fixed Recessed



Scheda tecnica
Datasheet

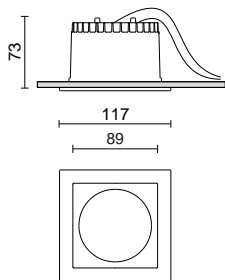

ALIMENTATORE NON INCLUSO
DRIVER NOT INCLUDED
misure in mm / measurements in mm

Bianco mat
Mat white

CE **IP43 IK08**

CODICE
CODE

DATI TECNICI
TECHNICAL DATA

	LUMEN	WATT	mA	CCT (K)	CRI	OTTICA OPTIC	FINITURA FINISH
259-200CN-21	1452	12	350	2700	85	55°	Bianco mat / Mat white
	2008	18	500	2700	85	55°	Bianco mat / Mat white
	2649	26	700	2700	85	55°	Bianco mat / Mat white
259-200BN-21	1513	12	350	3000	85	55°	Bianco mat / Mat white
	2092	18	500	3000	85	55°	Bianco mat / Mat white
	2759	26	700	3000	85	55°	Bianco mat / Mat white
259-200AN-21	1602	12	350	4000	85	55°	Bianco mat / Mat white
	2180	18	500	4000	85	55°	Bianco mat / Mat white
	2848	26	700	4000	85	55°	Bianco mat / Mat white

DRIVER DA ORDINARE SEPARATAMENTE
DRIVER TO ORDER SEPARATELY

mA	On / Off	MAINS DIMM.	1-10V	DALI/PUSH
350	-	81-04010	-	81-04003
500	81-04011	-	-	81-04002
700	81-04012	81-04044	81-04066	81-02413

OPZIONALE
OPTIONAL

CODICE CODE	DESCRIZIONE DESCRIPTION	CODICE CODE	DESCRIZIONE DESCRIPTION
28-3140-51	Ottica professionale S - fascio 18° Professional optic device S - beam 18°	28-4019-30	Frangiluce alveolare Honeycomb
28-3142-51	Ottica professionale M - fascio 30° Professional optic device M - beam 30°		
28-3141-31	Ottica professionale XW - fascio 70° Professional optic device XW - beam 70°		

Ottiche non pre-montate
Not pre-assembled optics

RA 11 TL DIXIT LED

Incasso fisso
Fixed Recessed



Scheda tecnica
Datasheet

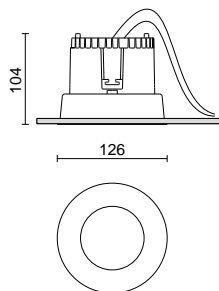

IP43

Ø122



ALIMENTATORE NON INCLUSO
DRIVER NOT INCLUDED
misure in mm / measurements in mm

Bianco mat
Mat white

CE 850° IP43 IK08

CODICE
CODE

DATI TECNICI
TECHNICAL DATA

	LUMEN	WATT	mA	CCT (K)	CRI	OTTICA OPTIC	FINITURA FINISH
257-200CN-21	1452	12	350	2700	85	55°	Bianco mat / Mat white
	2008	18	500	2700	85	55°	Bianco mat / Mat white
	2649	26	700	2700	85	55°	Bianco mat / Mat white
257-200BN-21	1513	12	350	3000	85	55°	Bianco mat / Mat white
	2092	18	500	3000	85	55°	Bianco mat / Mat white
	2759	26	700	3000	85	55°	Bianco mat / Mat white
257-200AN-21	1602	12	350	4000	85	55°	Bianco mat / Mat white
	2180	18	500	4000	85	55°	Bianco mat / Mat white
	2848	26	700	4000	85	55°	Bianco mat / Mat white

DRIVER DA ORDINARE SEPARATAMENTE

DRIVER TO ORDER SEPARATELY

mA	On / Off	MAINS DIMM.	1-10V	DALI/PUSH
350	-	81-04010	-	81-04003
500	81-04011	-	-	81-04002
700	81-04012	81-04044	81-04066	81-02413

OPZIONALE OPTIONAL

CODICE CODE	DESCRIZIONE DESCRIPTION	CODICE CODE	DESCRIZIONE DESCRIPTION
28-3140-51	Ottica professionale S - fascio 18° Professional optic device S - beam 18°	28-4019-30	Frangiluce alveolare Honeycomb
28-3142-51	Ottica professionale M - fascio 30° Professional optic device M - beam 30°		
28-3141-31	Ottica professionale XW - fascio 70° Professional optic device XW - beam 70°		

Ottiche non pre-montate
Not pre-assembled optics

RA 16

Incasso fisso
Fixed Recessed



Scheda tecnica
Datasheet

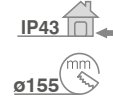
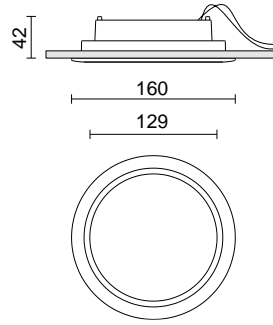

ALIMENTATORE NON INCLUSO
DRIVER NOT INCLUDED
misure in mm / measurements in mm

Bianco mat
Mat white

CE **IP43 IK07**



CODICE
CODE

DATI TECNICI
TECHNICAL DATA

	LUMEN	WATT	mA	CCT (K)	CRI	OTTICA OPTIC	FINITURA FINISH
250-220BN-21	1728	18	500	3000	85	110°	Bianco mat / Mat white
250-220AN-21	1764	18	500	4000	85	110°	Bianco mat / Mat white
250-230BN-21	2232	26	700	3000	85	110°	Bianco mat / Mat white
250-230AN-21	2522	26	700	4000	85	110°	Bianco mat / Mat white

SAO 113 10W

Incasso fisso
Fixed Recessed



Scheda tecnica
Datasheet

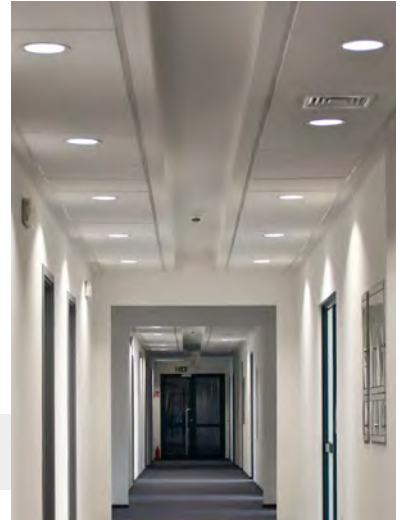
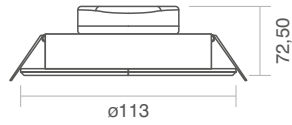

ALIMENTATORE INTEGRATO
INTEGRATED DRIVER

misure in mm / measurements in mm

PET Bianco
White PET

OTTICA 90°
OPTICS 90°

CE IP40

COMPOSIZIONE CODICE
CODE COMPOSITION

COD.BASE BASE CODE:	WATT WATT
S113-	10W (10W)

COLORE LED LED COLOR
C (bianco caldo/warm white)
N (bianco neutro/neutral white)

DATI TECNICI
TECHNICAL DATA

LUMEN	WATT	CRI
880	10	80
925	10	80

Configuratore di riferimento:
Reference configurator:

Es: S113-10WC

SAO 174 17W

Incasso fisso
Fixed Recessed



Scheda tecnica
Datasheet

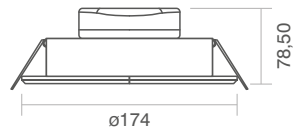

IP40

220 Vac

150 mm

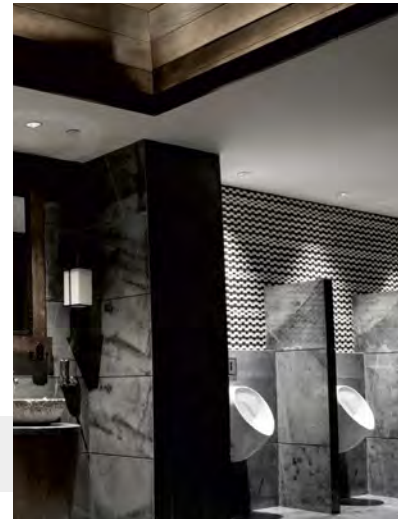

ALIMENTATORE INTEGRATO
INTEGRATED DRIVER

misure in mm / measurements in mm

PET Bianco
White PET

OTTICA 90°
OPTICS 90°

CE IP40

COMPOSIZIONE CODICE CODE COMPOSITION

COD.BASE BASE CODE:	WATT WATT
S174-	17W (17W)

COLORE LED LED COLOR
C (bianco caldo/warm white)
N (bianco neutro/neutral white)

DATI TECNICI TECHNICAL DATA

LUMEN	WATT	CRI
1575	17	80
1650	17	80

Configuratore di riferimento:
Reference configurator:

Es: S174-17WC

SAO 244 25W

Incasso fisso
Fixed Recessed



Scheda tecnica
Datasheet

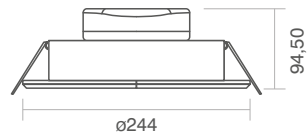

IP40

220 Vac

210 mm

ALIMENTATORE INTEGRATO
INTEGRATED DRIVER

misure in mm / measurements in mm



Configuratore di riferimento:
Reference configurator:

Es: S244-25WC

PET Bianco
White PET

OTTICA 90°
OPTICS 90°

CE IP40

COMPOSIZIONE CODICE CODE COMPOSITION

COD.BASE BASE CODE:	WATT WATT
S244-	25W (25W)

COLORE LED LED COLOR
C (bianco caldo/warm white)
N (bianco neutro/neutral white)

DATI TECNICI TECHNICAL DATA

LUMEN	WATT	CRI
2455	25	80
2585	25	80

SAO 279 40W

Incasso fisso
Fixed Recessed



Scheda tecnica
Datasheet

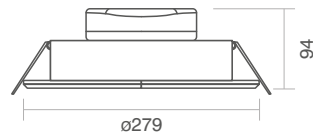

IP40

220 Vac

255 mm

ALIMENTATORE ESTERNO ON/OFF INCLUSO
EXTERNAL ON/OFF DRIVER INCLUDED
misure in mm / measurements in mm

PET Bianco
White PET

OTTICA 90°
OPTICS 90°

CE IP40



Configuratore di riferimento:
Reference configurator:

Es: S279-40WC

COMPOSIZIONE CODICE CODE COMPOSITION

COD.BASE BASE CODE:	WATT WATT
S279-	40W (40W)

COLORE LED LED COLOR
C (bianco caldo/warm white)
N (bianco neutro/neutral white)

DATI TECNICI TECHNICAL DATA

LUMEN	WATT	CRI
3600	40	80
3880	40	80

DOWNLIGHT 113 10W

3 COLORI in 1 / 3 COLORS in 1

Incasso fisso
Fixed Recessed



Scheda tecnica
Datasheet

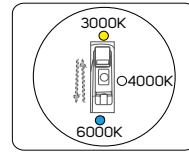
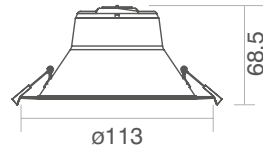

ALIMENTATORE ESTERNO ON/OFF INCLUSO
EXTERNAL ON/OFF DRIVER INCLUDED
misure in mm / measurements in mm



OTTICA 90°
OPTICS 90° UGR<19

CE IP20

COMPOSIZIONE CODICE CODE COMPOSITION

COD.BASE **COLORE LED**
BASE CODE: LED COLOR

DOW10S- **CNF** (bianco caldo-neutro-freddo
warm-neutral-cold white)

DATI TECNICI TECHNICAL DATA

LUMEN	WATT	CRI
800/880/880	10	80

Configuratore di riferimento:
Reference configurator:

Es: DOW10S-CNF

OPZIONALE OPTIONAL

03150
DRIVER 350-900mA 20W 1.10V-PUSH IP20

03151
DRIVER 350-900mA/24VDC 20W DALI IP20

DOWNLIGHT 174 20W

3 COLORI in 1 / 3 COLORS in 1

Incasso fisso
Fixed Recessed



Scheda tecnica
Datasheet

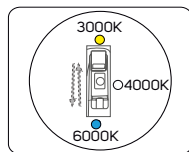
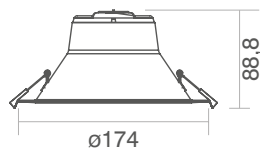

IP20

700 mA

Ø150

ALIMENTATORE ESTERNO ON/OFF INCLUSO
EXTERNAL ON/OFF DRIVER INCLUDED
misure in mm / measurements in mm



Configuratore di riferimento:
Reference configurator:

Es: DOW20S-CNF



Bianco
White

OTTICA 90°
OPTICS 90° UGR<19

CE IP20

COMPOSIZIONE CODICE CODE COMPOSITION

COD.BASE **COLORE LED**
BASE CODE: LED COLOR

DOW20S- **CNF** (bianco caldo-neutro-freddo
warm-neutral-cold white)

DATI TECNICI TECHNICAL DATA

LUMEN	WATT	CRI
1640/1800/1800	20	80

OPZIONALE OPTIONAL

09254
DRIVER 350-1050mA 40W DALI-PUSH IP20 MW

03230
DRIVER 350-1050mA 40W 1..10V IP20 MW

DOWNLIGHT 232 35W

3 COLORI in 1 / 3 COLORS in 1

Incasso fisso
Fixed Recessed



Scheda tecnica
Datasheet

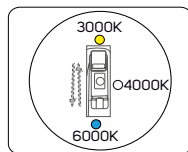
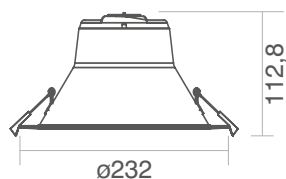
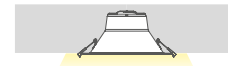

IP20

900 mA

Ø200 mm

ALIMENTATORE ESTERNO ON/OFF INCLUSO
EXTERNAL ON/OFF DRIVER INCLUDED
misure in mm / measurements in mm



Configuratore di riferimento:
Reference configurator:

Es: DOW35S-CNF

Bianco
White

OTTICA 90°
OPTICS 90° UGR<19

CE IP20

COMPOSIZIONE CODICE
CODE COMPOSITION

COD.BASE **COLORE LED**
BASE CODE: LED COLOR

DOW35S- **CNF** (bianco caldo-neutro-freddo
warm-neutral-cold white)

DATI TECNICI
TECHNICAL DATA

LUMEN	WATT	CRI
2870/3150/3150	35	80

OPZIONALE
OPTIONAL

09254
DRIVER 350-1050mA 40W DALI-PUSH IP20 MW

03230
DRIVER 350-1050mA 40W 1..10V IP20 MW

RA 14 DIXIT LED

Incasso fisso
Fixed Recessed



Scheda tecnica
Datasheet

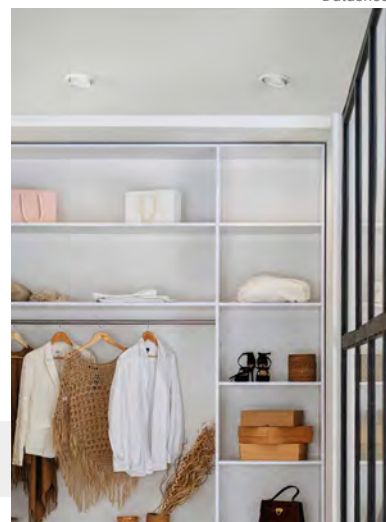
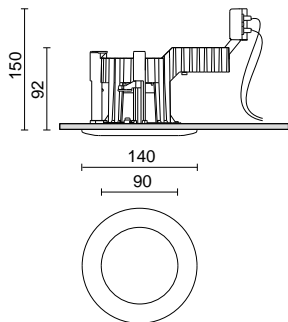

ALIMENTATORE NON INCLUSO
DRIVER NOT INCLUDED
misure in mm / measurements in mm

Bianco mat
Mat white

CE **IP43 IK08**

CODICE
CODE

DATI TECNICI
TECHNICAL DATA

	LUMEN	WATT	mA	CCT (K)	CRI	OTTICA OPTIC	FINITURA FINISH
243-250CN-21	2807	26	700	2700	85	60°	Bianco mat / Mat white
	3509	33	900	2700	85	60°	Bianco mat / Mat white
	4045	38	1050	2700	85	60°	Bianco mat / Mat white
243-250BN-21	2924	26	700	3000	85	60°	Bianco mat / Mat white
	3655	33	900	3000	85	60°	Bianco mat / Mat white
	4214	38	1050	3000	85	60°	Bianco mat / Mat white
243-250AN-21	3010	26	700	4000	85	60°	Bianco mat / Mat white
	3784	33	900	4000	85	60°	Bianco mat / Mat white
	4300	38	1050	4000	85	60°	Bianco mat / Mat white

DRIVER DA ORDINARE SEPARATAMENTE
DRIVER TO ORDER SEPARATELY

mA	On / Off	MAINS DIMM.	1-10V	DALI/PUSH
700	81-04012	81-04044	81-04066	81-02413
900	81-04015	-	-	-
1050	81-04013	-	-	81-04014

OPZIONALE
OPTIONAL

CODICE CODE	DESCRIZIONE DESCRIPTION
98-13380-61	Vetro sabbiato / Frosted glass



RA 20 DIXIT LED

Incasso fisso
Fixed Recessed



Scheda tecnica
Datasheet

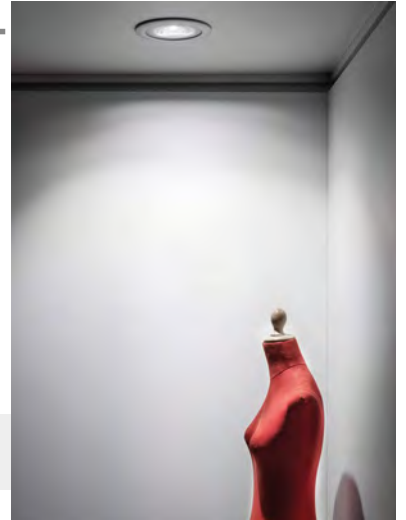
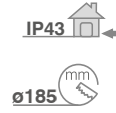
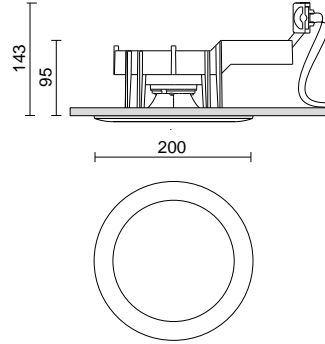

ALIMENTATORE NON INCLUSO
DRIVER NOT INCLUDED
misure in mm / measurements in mm

Bianco mat
Mat white

CE **IP43 IK07**

CODICE
CODE

DATI TECNICI
TECHNICAL DATA

	LUMEN	WATT	mA	CCT (K)	CRI	OTTICA OPTIC	FINITURA FINISH
244-242CN-21	5266	51	1400	2700	85	100°	Bianco mat / Mat white
244-242BN-21	5485	51	1400	3000	85	100°	Bianco mat / Mat white
244-242AN-21	5656	51	1400	4000	85	100°	Bianco mat / Mat white

DRIVER DA ORDINARE SEPARATAMENTE
DRIVER TO ORDER SEPARATELY

mA	On / Off	MAINS DIMM.	1-10V	DALI/PUSH
1400	81-04004 (Max 60W)	-	-	81-04016 (Max 60W)

RA 23 SP DIXIT LED

Incasso fisso
Fixed Recessed



Scheda tecnica
Datasheet

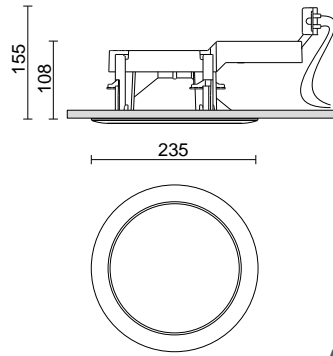

ALIMENTATORE NON INCLUSO
DRIVER NOT INCLUDED
misure in mm / measurements in mm

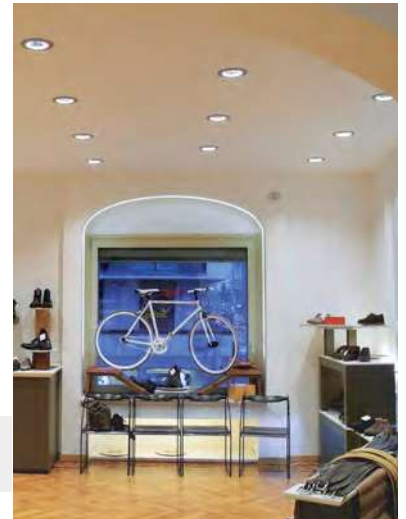

Bianco mat
Mat white

CE **IP43 IK07**

CODICE
CODE

DATI TECNICI
TECHNICAL DATA

	LUMEN	WATT	mA	CCT (K)	CRI	OTTICA OPTIC	FINITURA FINISH
249-240BN-21	5827	51	1400	3000	85	100°	Bianco mat / Mat white
249-240AN-21	5998	51	1400	4000	85	100°	Bianco mat / Mat white
249-250BN-21	9549	75	1400	3000	85	100°	Bianco mat / Mat white
249-250AN-21	10790	75	1400	4000	85	100°	Bianco mat / Mat white

DRIVER DA ORDINARE SEPARATAMENTE
DRIVER TO ORDER SEPARATELY

mA	On / Off	MAINS DIMM.	1-10V	DALI/PUSH
1400	81-04004 (Max 60W)	-	-	81-04016 (Max 60W)
1400	81-04018 (Max 100W)	-	-	-

NICOSIA 51

Incasso orientabile
Adjustable Recessed



Scheda tecnica
Datasheet

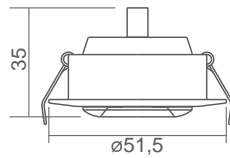

IP40

220 Vac

ø42,5 mm

ALIMENTATORE INCLUSO 220Vac
DRIVER INCLUDED 220Vac
misure in mm / measurements in mm

Alluminio bianco
White aluminum

OTTICA 20°
OPTICS 20°

CE IP40



Configuratore di riferimento:
Reference configurator:

Es: NCS-C

COMPOSIZIONE CODICE CODE COMPOSITION

COD.BASE **COLORE LED**
BASE CODE: LED COLOR

NCS- **C** (bianco caldo/warm white)
 N (bianco neutro/neutral white)

DATI TECNICI TECHNICAL DATA

LUMEN	WATT	CRI
230	3	80
250	3	80

OPZIONALE OPTIONAL

OPTIONAL

03150
DRIVER 350-900mA 20W 1.10V-PUSH IP20

03151
DRIVER 350-900mA/24VDC 20W DALI IP20

Accessori da utilizzare in applicazione remota con settaggio a 700mA (esterni al faretto)
Accessories to be used in remote application with setting at 700mA (external to the spotlight)

RA 8 DIXIT LED

Incasso orientabile
Adjustable Recessed



Scheda tecnica
Datasheet

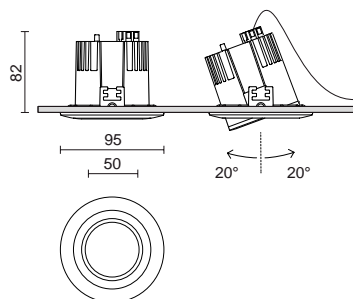

IP20

ø86



ALIMENTATORE NON INCLUSO
DRIVER NOT INCLUDED
misure in mm / measurements in mm

Bianco mat
Mat white

CE **IP20 IK08**

CODICE
CODE

DATI TECNICI
TECHNICAL DATA

	LUMEN	WATT	mA	CCT (K)	CRI	OTTICA OPTIC	FINITURA FINISH
239-250CN-21	1122	9	250	2700	80	26°	Bianco mat / Mat white
	1337	12	350	2700	80	26°	Bianco mat / Mat white
239-250BN-21	1169	9	250	3000	80	26°	Bianco mat / Mat white
	1602	12	350	3000	80	26°	Bianco mat / Mat white
239-250AN-21	1183	9	250	4000	80	26°	Bianco mat / Mat white
	1622	12	350	4000	80	26°	Bianco mat / Mat white

DRIVER DA ORDINARE SEPARATEMENTE
DRIVER TO ORDER SEPARATELY

mA	On / Off	MAINS DIMM.	DALI/PUSH
250	81-04009	-	81-04042
350	-	81-04010	81-04003

OPZIONALE
OPTIONAL

CODICE CODE	DESCRIZIONE DESCRIPTION
28-3868-51	Ottica professionale W - fascio 45° Professional optic device W - beam 45°
28-3868-31	Ottica professionale XW - fascio 65° Professional optic device XW - beam 65°



Ottiche non pre-montate
Not pre-assembled optics

RA 11 DIXIT LED

Incasso orientabile
Adjustable Recessed



Scheda tecnica
Datasheet

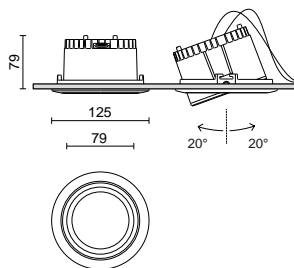

IP43

ø116



ALIMENTATORE NON INCLUSO
DRIVER NOT INCLUDED
misure in mm / measurements in mm

Bianco mat
Mat white

CE **IP43 IK08**

CODICE
CODE

DATI TECNICI
TECHNICAL DATA

	LUMEN	WATT	mA	CCT (K)	CRI	OTTICA OPTIC	FINITURA FINISH
256-200CN-21	1452	12	350	2700	85	55°	Bianco mat / Mat white
	2008	18	500	2700	85	55°	Bianco mat / Mat white
	2649	26	700	2700	85	55°	Bianco mat / Mat white
256-200BN-21	1513	12	350	3000	85	55°	Bianco mat / Mat white
	2092	18	500	3000	85	55°	Bianco mat / Mat white
	2759	26	700	3000	85	55°	Bianco mat / Mat white
256-200AN-21	1602	12	350	4000	85	55°	Bianco mat / Mat white
	2180	18	500	4000	85	55°	Bianco mat / Mat white
	2848	26	700	4000	85	55°	Bianco mat / Mat white

DRIVER DA ORDINARE SEPARATAMENTE
DRIVER TO ORDER SEPARATELY

mA	On / Off	MAINS DIMM.	1-10V	DALI/PUSH
350	-	81-04010	-	81-04003
500	81-04011	-	-	81-04002
700	81-04012	81-04044	81-04066	81-02413

OPZIONALE
OPTIONAL

CODICE CODE	DESCRIZIONE DESCRIPTION	CODICE CODE	DESCRIZIONE DESCRIPTION
28-3140-51	Ottica professionale S - fascio 18° Professional optic device S - beam 18°	28-4019-30	Frangiluce alveolare Honeycomb
28-3142-51	Ottica professionale M - fascio 30° Professional optic device M - beam 30°		
28-3141-31	Ottica professionale XW - fascio 70° Professional optic device XW - beam 70°		

Ottiche non pre-montate
Not pre-assembled optics

RA 17 DIXIT LED

Incasso orientabile
Adjustable Recessed



Scheda tecnica
Datasheet

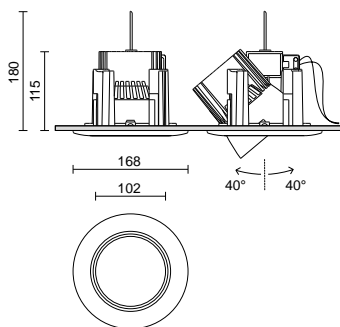

IP20
 $\varnothing 155$

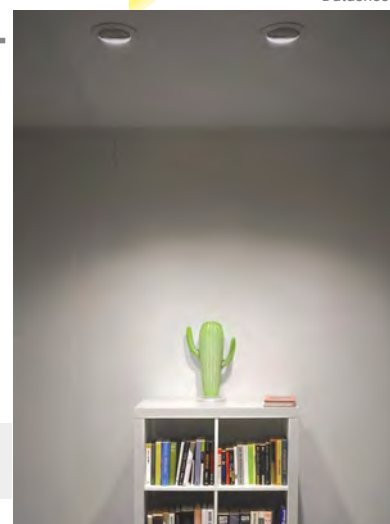

ALIMENTATORE NON INCLUSO
DRIVER NOT INCLUDED
misure in mm / measurements in mm

Bianco mat
Mat white

CE **IP20 IK07**

CODICE
CODE

DATI TECNICI
TECHNICAL DATA

	LUMEN	WATT	mA	CCT (K)	CRI	OTTICA OPTIC	FINITURA FINISH
248-230CN-21	3619	33	900	2700	85	30°	Bianco mat / Mat white
248-230BN-21	3770	33	900	3000	85	30°	Bianco mat / Mat white
248-230AN-21	4260	33	900	4000	85	30°	Bianco mat / Mat white

DRIVER DA ORDINARE SEPARATAMENTE
DRIVER TO ORDER SEPARATELY

mA	On / Off
900	81-04015

OPZIONALE
OPTIONAL

CODICE CODE	DESCRIZIONE DESCRIPTION
28-3140-51	Ottica professionale S - fascio 17° Professional optic device S - beam 17°
28-3138-51	Ottica professionale W - fascio 55° Professional optic device W - beam 55°
28-3141-31	Ottica professionale XW - fascio 70° Professional optic device XW - beam 70°



Ottiche non pre-montate
Not pre-assembled optics

KIEV 158

Incasso orientabile estraibile
Removable adjustable Recessed



Scheda tecnica
Datasheet

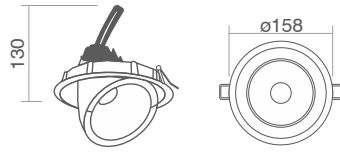

IP20

220 Vac

Ø140

ALIMENTATORE INCLUSO 220Vac
DRIVER INCLUDED 220Vac
misure in mm / measurements in mm

Alluminio bianco
White aluminum

OTTICA 40°
OPTICS 40°

CE IP20

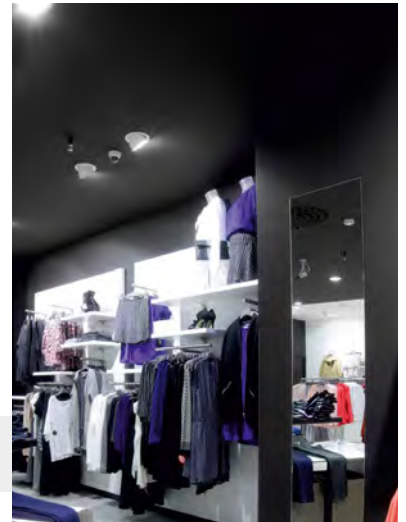

Configuratore di riferimento:
Reference configurator:

Es: KI38-C

COMPOSIZIONE CODICE CODE COMPOSITION

COD.BASE **COLORE LED**
BASE CODE: LED COLOR

KI38- **C** (bianco caldo/warm white)
 N (bianco neutro/neutral white)

DATI TECNICI TECHNICAL DATA

LUMEN	WATT	CRI
2400	38	90
2600	38	90

OPZIONALE OPTIONAL

09254

DRIVER 350-1050mA 40W DALI-PUSH IP20 MW

03230

DRIVER 350-1050mA 40W 1..10V IP20 MW

Accessori da utilizzare in applicazione remota con settaggio a 500mA (esterni al faretto)
Accessories to be used in remote application with setting at 500mA (external to the spotlight)

KIEV 188

Incasso orientabile estraibile
Removable adjustable Recessed



Scheda tecnica
Datasheet

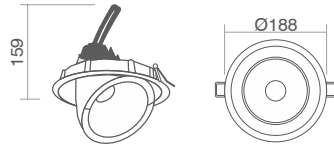

IP20

220 Vac

Ø172

ALIMENTATORE INCLUSO 220Vac
DRIVER INCLUDED 220Vac
misure in mm / measurements in mm

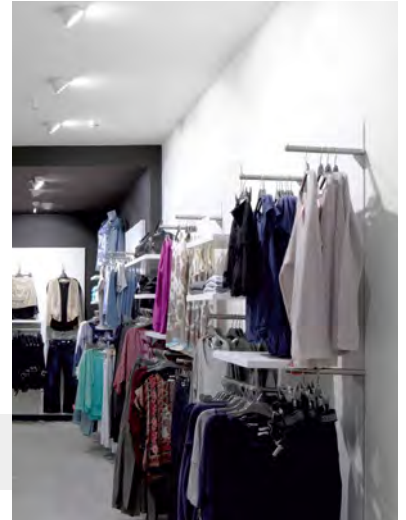

Configuratore di riferimento:
Reference configurator:

Es: KI40-C

Alluminio bianco
White aluminum

OTTICA 40°
OPTICS 40°

CE IP20

COMPOSIZIONE CODICE CODE COMPOSITION

COD.BASE **COLORE LED**
BASE CODE: LED COLOR

KI40- **C** (bianco caldo/warm white)
 N (bianco neutro/neutral white)

DATI TECNICI TECHNICAL DATA

LUMEN	WATT	CRI
2960	40	90
3100	40	90

OPZIONALE OPTIONAL

09254

DRIVER 350-1050mA 40W DALI-PUSH IP20 MW

03230

DRIVER 350-1050mA 40W 1..10V IP20 MW

Accessori da utilizzare in applicazione remota con settaggio a 500mA (esterni al faretto)
Accessories to be used in remote application with setting at 500mA (external to the spotlight)

Cielo stellato

Starry sky





Emozioni di luce

Emotions of light

Il sistema di illuminazione a fibre ottiche offre la possibilità di illuminare ambienti difficili da raggiungere, come ambienti esposti alle intemperie o soggetti a fonti di calore o umidità. Questo sistema permette di posizionare la sorgente di luce in un luogo facilmente accessibile e adatto per agevolare la manutenzione. Grazie alla sua elevata flessibilità, permette la creazione di disegni ed effetti scenografici unici sul soffitto, rendendo possibile una soluzione di illuminazione altamente creativa ed esteticamente accattivante.

The fiber optic lighting system provides the possibility to illuminate hard-to-reach environments, such as areas exposed to weather conditions or subject to heat or humidity sources. This system allows positioning the light source in an easily accessible location, facilitating maintenance. Thanks to its high flexibility, it enables the creation of unique designs and scenographic effects on the ceiling, making it possible to achieve a highly creative and aesthetically captivating lighting solution.



CIELO STELLATO FIBRE OTTICHE SINTETICHE RGB+W

STARRY SKY SYNTHETIC OPTICAL FIBERS RGB+W



Scheda tecnica
Datasheet

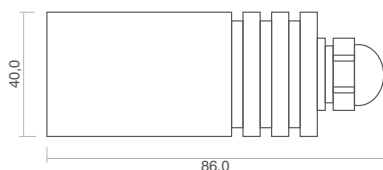

misure in mm / measurements in mm



IP54

IP65 su richiesta/ on request

COMPOSIZIONE CODICE

CODE COMPOSITION

COD.BASE BASE CODE:	WATT	N° PUNTI LUCE N° LIGHT POINTS
FOL-	3 (3W)	J5 (50)
	9 (9W)	J10 (100)
		J15 (150)
		J20 (200)

Disponibile solo versione bianco neutro.

Only neutral white version available.

Raffreddamento senza ventilatore (fanless).
Cooling without fan (fanless).

Vita LED 50.000 ore.
LED life 50.000 hours.

220-240VAC / 50-60Hz

Configuratore di riferimento:
Reference configurator:

Es: FOL-3J10

PUNTI LUCE CONSIGLIATI

RECOMMENDED LIGHT POINTS

50 punti/points = 1,5 mq
100 punti/points = 2,5 mq
150 punti/points = 3,0 mq
200 punti/points = 3,5 mq

CONTROLLO COLORI TRAMITE TELECOMANDO A RADIOFREQUENZA

COLOR CONTROL THROUGH RADIOFREQUENCY REMOTE CONTROL

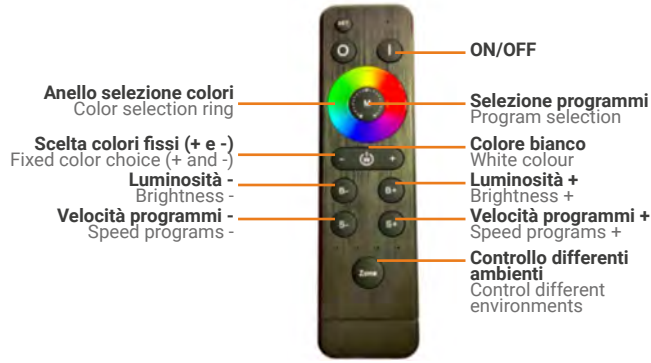

FUNZIONI / FUNCTIONS

ON/OFF

Accensione e spegnimento.

ON/OFF

Turning on and off

SELEZIONE PROGRAMMI

8 programmi.

PROGRAM SELECTION

8 programs.

ANELLO SELEZIONE COLORI

Selezione colori tramite contatto.

Regolazione luminosità.

COLOR SELECTION RING

Color selection by contact

Brightness adjustment.

COLORE BIANCO

Tasto per LED colore bianco.

WHITE COLOR

Button for white LED

VELOCITA' + / LUMINOSITA' +

Aumento velocità in modalità cambio colori.

Aumento luminosità su colori fissi.

SPEED + / BRIGHTNESS +

Speed increase in color change mode.

Brightness increase on fixed colors.

VELOCITA' - / LUMINOSITA' -

Diminuzione velocità in modalità cambio colori.

Diminuzione luminosità su colori fissi.

SPEED - / BRIGHTNESS -

Speed decrease in color change mode

Decreased brightness on fixed colors.

CONTROLLO DIFFERENTI AMBIENTI

Gestione di differenti ambienti tramite

cambio frequenza del telecomando.

CONTROL DIFFERENT ENVIRONMENTS

Management of different environments by switching.

MODULO RICEVITORE SEGNALE R.F.

R.F. SIGNAL RECEIVER MODULE



TELECOMANDO R.F.
R.F. REMOTE CONTROL

ILLUMINATORE
ILLUMINATOR

Cestelli

Baskets





Rendi semplice l'installazione

Installation made easy

Alloggi dedicati per i faretti Spot LED con diverse forme e strutture, permettono di proteggere i faretti ed installarli nel modo più pratico e sicuro. Adatti per installazione con cornice a vista oppure a raso soffitto e di forma tonda o quadrata, per rispondere ad ogni esigenza di progettazione. Sono ideali per applicazioni in contesti residenziali, hospitality, retail e office.

I cestelli sono compatibili con gli Spot LED di pagina 348.

Dedicated housings for Spot LED spotlights with different shapes and structures, allow you to protect the spotlights and install them in the most practical and safe way. They are suitable for installation with a visible frame or flush ceiling, and they come in round or square shapes to meet any design requirement. They are ideal for applications in residential, hospitality, retail, and office settings.

The housings are compatible with the Spot LEDs on page 348.



CESTELLO - LAKIN 83

Incasso orientabile
Adjustable recessed



Scheda tecnica
Datasheet

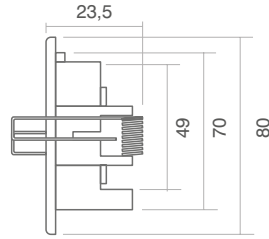

ø73

misure in mm / measurements in mm

Bianco White
 Nero Black
 Grigio Grey
 Nickel satinato Satin nickel
 Cromo Chrome

COMPOSIZIONE CODICE CODE COMPOSITION

COD.BASE
BASE CODE:

FINITURA
FINISH

COMPATIBILE CON:
COMPATIBLE WITH:

PAGINA:
PAGE:

PLT88-

- 01 (Bianco/White)
- 02 (Nero/Black)
- 03 (Grigio/Gray)
- 04 (Nickel satinato/Satin nickel)
- 05 (Cromo/Chrome)

SP50 SPOTLED 3W
SP50 SPOTLED 9W
SP50 SPOTLED 11W RGB

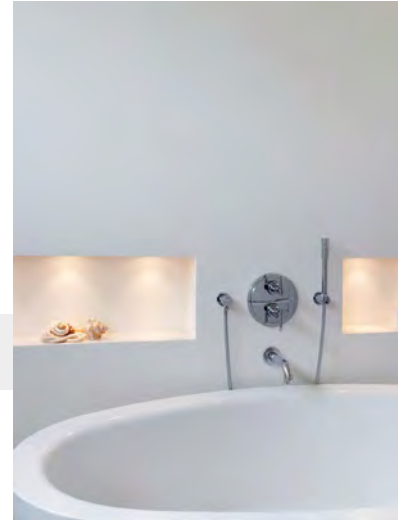

Configuratore di riferimento:
Reference configurator:

Es: PLT88-01

CESTELLO - ARDEA 102

Incasso orientabile
Adjustable recessed



Scheda tecnica
Datasheet

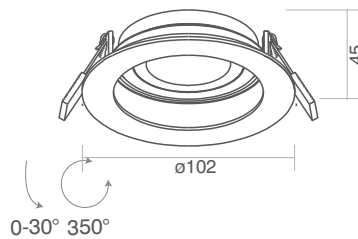

ø90

misure in mm / measurements in mm

Bianco White
 Nero Black

COMPOSIZIONE CODICE CODE COMPOSITION

COD.BASE
BASE CODE:

FINITURA
FINISH

COMPATIBILE CON:
COMPATIBLE WITH:

PAGINA:
PAGE:

AR102-

- 01 (Bianco/White)
- 02 (Nero/Black)

SP50 SPOTLED 3W
SP50 SPOTLED 9W
SP50 SPOTLED 11W RGB

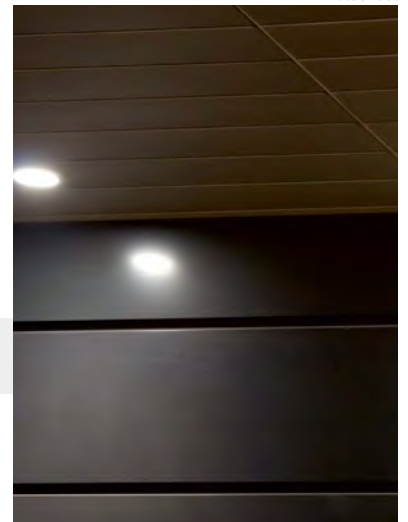

Configuratore di riferimento:
Reference configurator:

Es: AR102-01

CESTELLO - NEMI 93 T

Incasso interno orientabile
Adjustable internal recessed



Scheda tecnica
Datasheet

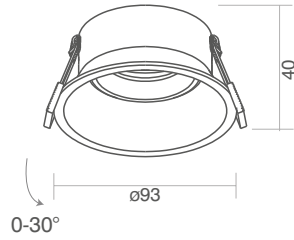

ø87

misure in mm / measurements in mm

Bianco
White Nero
Black

COMPOSIZIONE CODICE
CODE COMPOSITION

COD.BASE **FINITURA**
BASE CODE: FINISH

NE93- **01** (Bianco/White)
 02 (Nero/Black)

COMPATIBILE CON:
COMPATIBLE WITH:

SP50 SPOTLED 3W
SP50 SPOTLED 9W
SP50 SPOTLED 11W RGB

PAGINA:
PAGE:

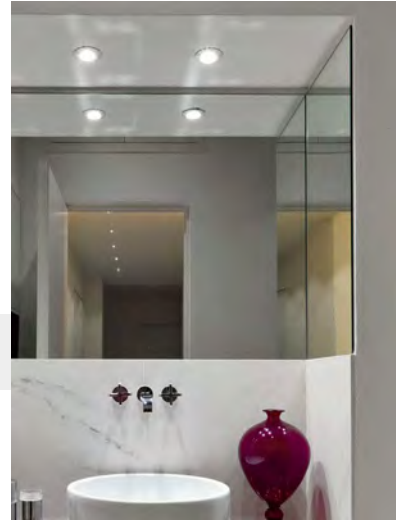

Configuratore di riferimento:
Reference configurator:
Es: NE93-01

CESTELLO - NEMI 93 Q

Incasso orientabile
Adjustable recessed



Scheda tecnica
Datasheet

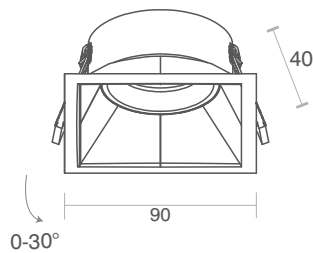

83x83

misure in mm / measurements in mm

Bianco
White Nero
Black

COMPOSIZIONE CODICE
CODE COMPOSITION

COD.BASE **FINITURA**
BASE CODE: FINISH

NE90- **01** (Bianco/White)
 02 (Nero/Black)

COMPATIBILE CON:
COMPATIBLE WITH:

SP50 SPOTLED 3W
SP50 SPOTLED 9W
SP50 SPOTLED 11W RGB

PAGINA:
PAGE:



Configuratore di riferimento:
Reference configurator:
Es: NE90-01

CESTELLO - MADAMA 79

Incasso fisso
Fixed recessed



Scheda tecnica
Datasheet

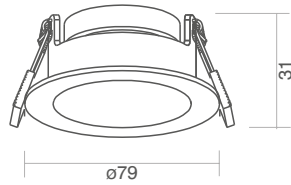

misure in mm / measurements in mm

Bianco / deflettore nero
White / black deflector

COMPOSIZIONE CODICE
CODE COMPOSITION

COD.BASE **FINITURA**
BASE CODE: FINISH

MA79- **0102** (Bianco e Nero/White and Black)

COMPATIBILE CON:
COMPATIBLE WITH:

SP50 SPOTLED 3W
SP50 SPOTLED 9W
SP50 SPOTLED 11W RGB

PAGINA:
PAGE:



Configuratore di riferimento:
Reference configurator:

Es: MA79-0102

CESTELLO - LATINA 76

Incasso fisso
Fixed recessed



Scheda tecnica
Datasheet

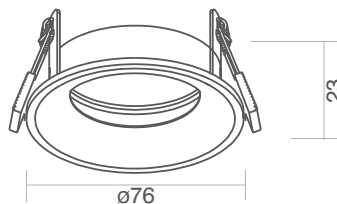

misure in mm / measurements in mm

Bianco Nero
White Black

COMPOSIZIONE CODICE
CODE COMPOSITION

COD.BASE **FINITURA**
BASE CODE: FINISH

LA76- **01** (Bianco/White)
 02 (Nero/Black)

COMPATIBILE CON:
COMPATIBLE WITH:

SP50 SPOTLED 3W
SP50 SPOTLED 9W
SP50 SPOTLED 11W RGB

PAGINA:
PAGE:



Configuratore di riferimento:
Reference configurator:

Es: LA76-01

CESTELLO - SANDY 86

Incasso fisso
Fixed recessed



Scheda tecnica
Datasheet

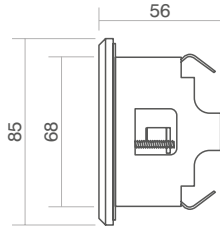

misure in mm / measurements in mm

Bianco White
 Nero Black
 Grigio Grey
 Nickel satinato Satin nickel
 Cromo Chrome

IP65 parte frontale
IP65 front side

COMPOSIZIONE CODICE

CODE COMPOSITION

COD.BASE **FINITURA**
BASE CODE: FINISH

PLQ86-

- 01 (Bianco/White)
- 02 (Nero/Black)
- 03 (Grigio/Gray)
- 04 (Nickel satinato/Satin nickel)
- 05 (Cromo/Chrome)

COMPATIBILE CON:
COMPATIBLE WITH:

SP50 SPOTLED 3W
SP50 SPOTLED 9W
SP50 SPOTLED 11W RGB

PAGINA:
PAGE:



Configuratore di riferimento:
Reference configurator:
Es: PLQ86-01

CESTELLO - CLARK 90

Incasso fisso
Fixed recessed



Scheda tecnica
Datasheet

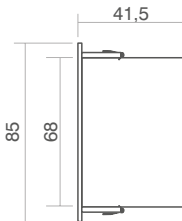

misure in mm / measurements in mm

Bianco White
 Nero Black
 Grigio Grey
 Nickel satinato Satin nickel
 Cromo Chrome

IP65 parte frontale
IP65 front side

COMPOSIZIONE CODICE

CODE COMPOSITION

COD.BASE **FINITURA**
BASE CODE: FINISH

PLT85-

- 01 (Bianco/White)
- 02 (Nero/Black)
- 03 (Grigio/Gray)
- 04 (Nickel satinato/Satin nickel)
- 05 (Cromo/Chrome)

COMPATIBILE CON:
COMPATIBLE WITH:

SP50 SPOTLED 3W
SP50 SPOTLED 9W
SP50 SPOTLED 11W RGB

PAGINA:
PAGE:



Configuratore di riferimento:
Reference configurator:
Es: PLT85-02

Spotled

SpotLEDs





Nuova luce ai tuoi progetti

A new light for your projects

Gli SpotLED sono una delle tecnologie più performanti e valide che sfruttano la tecnologia dell'illuminazione a LED. Permettono di avere un grande risparmio energetico rispetto ai tradizionali faretto alogeni, assicurando inoltre prestazioni di alto livello anche per lunghissimo periodo di utilizzo. Disponibili in versione monocoloro o RGB. Sono compatibili con la gamma di cestelli di pag 342.



SpotLED is one of the most performing and valid technologies that take advantage of LED lighting technology. They allow to have a great energy saving compared to traditional halogen spotlights, also ensuring high level performance even for a very long period of use. They come in single color or RGB version. They are compatible with the baskets range on page 342.

SPOTLED - ø50 3W



Scheda tecnica
Datasheet

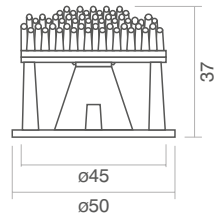

misure in mm / measurements in mm



Configuratore di riferimento:
Reference configurator:
Es: SP50-N1

COMPOSIZIONE CODICE CODE COMPOSITION

COD.BASE BASE CODE:	COLORE LED LED COLOR	OTTICA OPTICS
SP50-	C (bianco caldo/warm white)	1 (10°)
	N (bianco neutro/neutral white)	2 (25°)
	F (bianco freddo/cold white)	4 (40°)

DATI TECNICI TECHNICAL DATA

LUMEN	WATT
390	3
420	3
435	3

SPOTLED - ø50 9W



Scheda tecnica
Datasheet

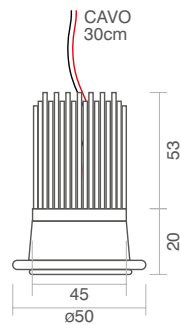

misure in mm / measurements in mm

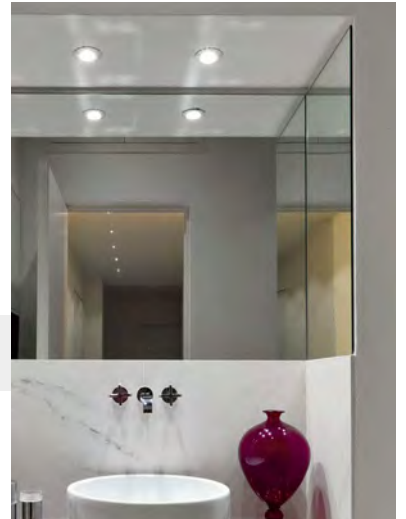

Configuratore di riferimento:
Reference configurator:
Es: SP50-9W-Z4

Riflettore ad alte prestazioni con vetro di protezione integrato
High-performing reflector with integrated protection glass

Misura standard MR16
Standard size MR16

COMPOSIZIONE CODICE CODE COMPOSITION

COD.BASE BASE CODE:	COLORE LED LED COLOR	OTTICA OPTICS
SP50-9W-	Z (bianco 2700K/2700K white)	4 (42°)
	C (bianco caldo/warm white)	9 (90°)
	N (bianco neutro/neutral white)	

DATI TECNICI TECHNICAL DATA

LUMEN	WATT
1260	9
1290	9
1365	9

SPOTLED - Ø50 11W RGB



Scheda tecnica
Datasheet

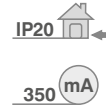
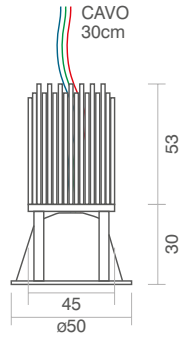

misure in mm / measurements in mm

Misura standard MR16
Standard size MR16



Configuratore di riferimento:
Reference configurator:
Es: SP50-11W-H2

COMPOSIZIONE CODICE CODE COMPOSITION

COD.BASE **COLORE LED**
BASE CODE: LED COLOR

SP50-11W- H (RGB)

OTTICA
OPTICS

2 (25°)
4 (40°)

DATI TECNICI
TECHNICAL DATA

LUMEN **WATT**
315 **11**

Faretti a plafone

Ceiling lights



PF sono modelli di design depositato.
Design: Enrico Davide Bona e Elisa Nobile.

PF are registered design models.
Design by Enrico Davide Bona and Elisa Nobile.



Design rigoroso, funzionalità garantita

Strict design and guaranteed functionality

Le plafoniere PF sono progettate espressamente per la tecnologia LED COB di ultima generazione, garantendo una qualità della luce dalle elevate prestazioni. La gamma si caratterizza per un profilo sottile e da forme geometriche pure come il cerchio e il quadrato, che consentono di collocare i prodotti in spazi anche con altezze ridotte, in ambiti sia residenziali sia pubblici.

The PF ceiling luminaires have been specially designed to be equipped with COB LED sources of last generation, for high quality and high performance in lighting. The range is extremely shallow, featuring pure geometric shapes such as the circle and the square, thus it is ideal for a number of applications including low ceilings, both in public and in residential spaces.



PERFETTO COMPACT BASE

CON BASE / WITH BASE

Faretti a plafone / Ceiling lights

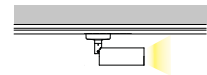

Scheda tecnica
Datasheet

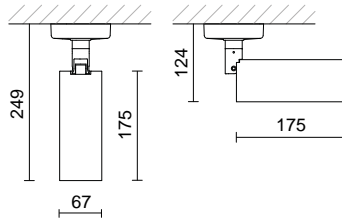

1,1 Kg

CON BASETTA
WITH BASE

misure in mm / measurements in mm

Bianco mat
Mat white

Nero
Black

CE IP20

220/240V - 50/60Hz

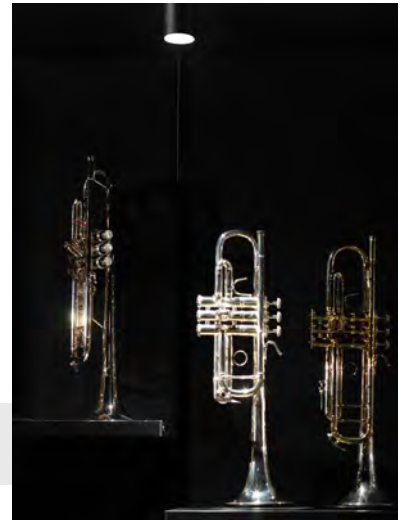

CODICE
CODE

DATI TECNICI
TECHNICAL DATA

	LUMEN	WATT	CCT (K)	CRI	OTTICA OPTIC	FINITURA FINISH
751-221CX-21	2187	26	2700	85	29°	Bianco mat / Mat white
751-221CX-16	2187	26	2700	85	29°	Nero / Black
751-221BX-21	2278	26	3000	85	29°	Bianco mat / Mat white
751-221BX-16	2278	26	3000	85	29°	Nero / Black
751-221AX-21	2574	26	4000	85	29°	Bianco mat / Mat white
751-221AX-16	2574	26	4000	85	29°	Nero / Black

OPZIONALE
OPTIONAL

CODICE CODE	DESCRIZIONE DESCRIPTION	
28-9004-30	Cilindro antiabbagliamento Snoot	
28-4080-30	Frangiluce alveolare (da utilizzare con cod. 28-9004-30) Honeycomb (to be used with code 28-9004-30)	
28-3905-47	Schermo di chiusura in termoplastico trasparente Closing screen in clear thermoplastic material	



PF 15

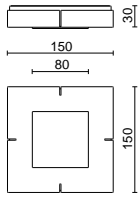

Plafone
Ceiling



Scheda tecnica
Datasheet

IP43

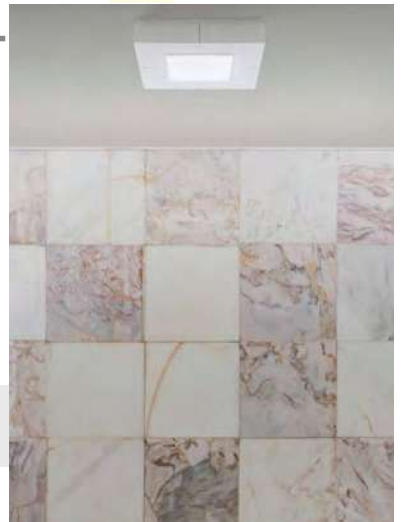

DIFFUSORE IN POLICARBONATO OPALE AD ALTA CAPACITA' DIFFONDENTE
OPAL POLYCARBONATE DIFFUSER WITH HIGH LIGHT-DIFFUSION CAPACITY

misure in mm / measurements in mm

Bianco mat
Mat white

CE **IP43**

230/240V - 50/60Hz

CODICE
CODE

DATI TECNICI
TECHNICAL DATA

	LUMEN	WATT	CCT (K)	CRI	OTTICA OPTIC	FINITURA FINISH
3825-01-21	1088	12	3000	85	110°	Bianco mat / Mat white

PF 22

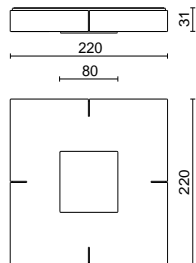

Plafone
Ceiling



Scheda tecnica
Datasheet

IP43

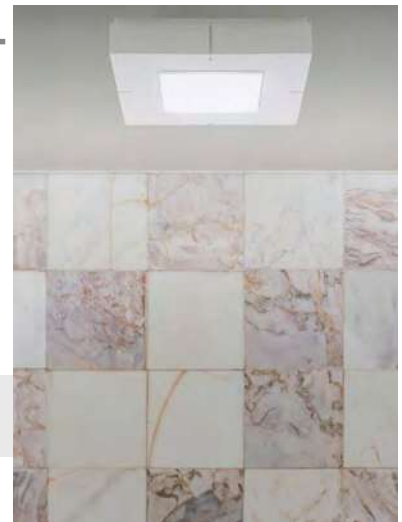

DIFFUSORE IN POLICARBONATO OPALE AD ALTA CAPACITA' DIFFONDENTE
OPAL POLYCARBONATE DIFFUSER WITH HIGH LIGHT-DIFFUSION CAPACITY

misure in mm / measurements in mm

Bianco mat
Mat white

CE **IP43**

230/240V - 50/60Hz

CODICE
CODE

DATI TECNICI
TECHNICAL DATA

	LAMPADA LAMP	WATT	CCT (K)	CRI	OTTICA OPTIC	FINITURA FINISH
3830-01-21	1721	18	3000	85	110°	Bianco mat / Mat white

PF 19

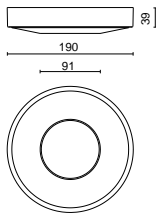

Plafone
Ceiling



Scheda tecnica
Datasheet

IP44

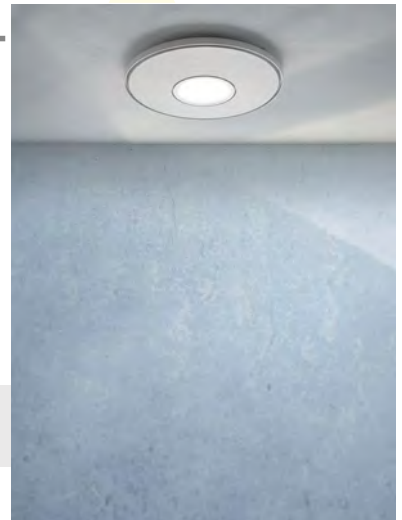

DIFFUSORE IN POLICARBONATO OPALE AD ALTA CAPACITA' DIFFONDENTE
OPAL POLYCARBONATE DIFFUSER WITH HIGH LIGHT-DIFFUSION CAPACITY

misure in mm / measurements in mm

Bianco mat
Mat white

CE **IP44**

230/240V - 50/60Hz

CODICE
CODE

DATI TECNICI
TECHNICAL DATA

3881-01-21

LUMEN	WATT	CCT (K)	CRI	OTTICA OPTIC	FINITURA FINISH
1320	12	3000	85	110°	Bianco mat / Mat white

12W: regolabile sulla fase / dimmable on the mains

PF 30

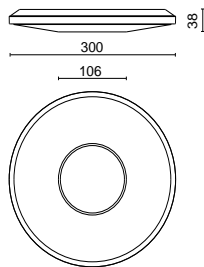

Plafone
Ceiling



Scheda tecnica
Datasheet

IP40



DIFFUSORE IN POLICARBONATO OPALE AD ALTA CAPACITA' DIFFONDENTE
OPAL POLYCARBONATE DIFFUSER WITH HIGH LIGHT-DIFFUSION CAPACITY

misure in mm / measurements in mm

Bianco mat
Mat white

CE **IP40**

230/240V - 50/60Hz

CODICE
CODE

DATI TECNICI
TECHNICAL DATA

3888-02-21

LAMPADA LAMP	WATT	CCT (K)	CRI	OTTICA OPTIC	FINITURA FINISH
2479	26	3000	85	110°	Bianco mat / Mat white

Faretti applique

Wall lights





La luce è atmosfera

Light is atmosphere

Le nostre applique esprimono al meglio il potenziale pensato in fase di sviluppo: nessun dettaglio è lasciato al caso, l'unico obiettivo è la valorizzazione degli ambienti. Combinando design e fonti luminose LED di ultima generazione, si adattano alla parete in maniera discreta e accattivante, per una diffusione di luce piacevole e funzionale.



Our wall lights best express the potential conceived in the development phase: no detail is left to chance, the only purpose is the magnification of the spaces. The wall lights combine design and LED luminous sources of last generation. Their shape fits on the wall with a sober and appealing look, providing a pleasant and functional light diffusion.

GIADA

Applique
Wall



Scheda tecnica
Datasheet



IP20

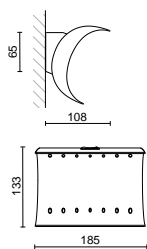

MONODIREZIONALE
SINGLE LIGHT

misure in mm / measurements in mm

Bianco mat
Mat white

CE **IP20**

230/240V - 50/60Hz

CODICE
CODE

DATI TECNICI
TECHNICAL DATA

	LUMEN	WATT	CCT (K)	CRI	OTTICA OPTIC	FINITURA FINISH
3740-01-21	3350	30	3000	85	110°	Bianco mat / Mat white

GIADA 200

Applique
Wall



Scheda tecnica
Datasheet



IP20

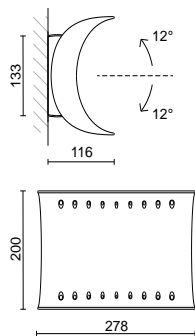

BIDIREZIONALE A DOPPIA ACCENSIONE
INCLINABILE +/- 12°
BI-DIRECTIONAL DOUBLE SWITCH
TILTABLE +/- 12°

misure in mm / measurements in mm

Bianco mat
Mat white

CE **IP20**

CODICE
CODE

DATI TECNICI
TECHNICAL DATA

	LAMPADA LAMP	WATT	CCT (K)	CRI	OTTICA OPTIC	FINITURA FINISH
3741-01-21	6120+1620	51+12	3000	85	115°	Bianco mat / Mat white

AP LINE

Applique
Wall



Scheda tecnica
Datasheet

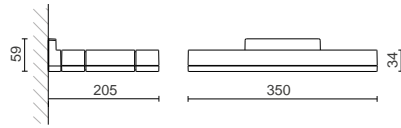

IP40

**DIFFUSORE IN POLICARBONATO OPALE
AD ALTA CAPACITA' DIFFONDENTE**
OPAL POLYCARBONATE DIFFUSER WITH HIGH
LIGHT-DIFFUSION CAPACITY

misure in mm / measurements in mm

Bianco mat
Mat white

CE **IP40**

220/240V - 50/60Hz



CODICE
CODE

DATI TECNICI
TECHNICAL DATA

	LUMEN	WATT	CCT (K)	CRI	OTTICA OPTIC	FINITURA FINISH
3748-01-21	2128	30	3000	85	110°	Bianco mat / Mat white

Faretti a sospensione

Suspension



Floot (sopra) è modello di design depositato.
Design: Enrico Davide Bona e Elisa Nobile.

Floot (above) is a registered design model.
Design by Enrico Davide Bona and Elisa Nobile.



Luce al servizio dello spazio

Light serving the space

Un design attuale, ma allo stesso tempo innovativo rende queste sospensioni una presenza visibile ma allo stesso tempo leggera. Ideali per applicazioni in ambienti residenziali, ma anche in strutture commerciali, negozi, magazzini e studi professionali. Questi apparecchi si possono sospendere su binari elettrificati trifase LKM grazie a specifici accessori.



A contemporary yet innovative design makes these suspensions a visible but also lightweight presence. Ideal for residential use, as well as in commercial facilities, shops, warehouses, and professional studios. These fixtures can be suspended on LKM three-phase electrified tracks thanks to proper accessories.

FLOOT

Sospensione
Suspension



Scheda tecnica
Datasheet

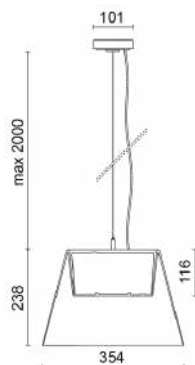

4,1 Kg

DIFFUSORE IN POLICARBONATO TRASLUCIDO
DIFFUSER IN TRANSLUCENT POLYCARBONATE

misure in mm / measurements in mm



Bianco - Traslucido
White - Translucent

CE **IP20 IK06**

220/240V - 50/60Hz

CODICE CODE	DATI TECNICI TECHNICAL DATA					
	LUMEN	WATT	CCT (K)	CRI	OTTICA OPTIC	FINITURA FINISH
3916-01-06	4258	33	3000	85	70°	Bianco - Traslucido / White - Translucent
3915-01-06	5873	51	3000	85	70°	Bianco - Traslucido / White - Translucent

OPZIONALE OPTIONAL

CODICE CODE	DESCRIZIONE DESCRIPTION	CODICE CODE	DESCRIZIONE DESCRIPTION
28-3140-51	Ottica professionale S: fascio 17° (33W) / fascio 25° (51W) Professional optic device S: beam 17° (33W) / beam 25° (51W)	28-3957-30	Cilindro antiabbagliamento Snoot
28-3142-51	Ottica professionale M: fascio 30° (33W) / fascio 40° (51W) Professional optic device M: beam 30° (33W) / beam 40° (51W)	28-4536-30	Frangiluce alveolare (da utilizzare con cod. 28-3957-30) Honeycomb (to be used with code 28-3957-30)
28-3138-51	Ottica professionale W: fascio 55° (33W) / fascio 60° (51W) Professional optic device W: beam 55° (33W) / beam 60° (51W)	7558-00-31	Adattatore elettromeccanico LKM 6A bianco White LKM electro/mechanical adapter 6A
		7618-00-31	Adattatore meccanico bianco con bloccacavo White mechanical adapter with locking device

Ottiche non pre-montate
Not pre-assembled optics

ZEPPEL 400

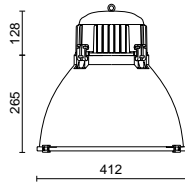

3,2 Kg

**KIT DI SOSPENSIONE
ORDINABILE SEPARATAMENTE
SUSPENSION KIT
ORDERED SEPARATELY**

**SCHERMO DI PROTEZIONE IN VETRO TEMPRATO 4MM
SAFETY SCREEN IN 4MM TEMPERED GLASS**

misure in mm / measurements in mm

- Metal - Traslucido / Silver - Translucent
- Nero - Traslucido / Black - Translucent
- Metal - Metallizzato / Silver - Metallized
- Nero - Metallizzato / Black - Metallized

CE **IP44 IK08**

Sospensione
Suspension



Scheda tecnica
Datasheet



CODICE CODE

439-011-26
439-011-33
439-011-27
439-011-38

DATI TECNICI TECHNICAL DATA

ATTACCO BASE

E27
E27
E27
E27

FINITURA FINISH

Metal - Traslucido / Silver - Translucent
Nero - Traslucido / Black - Translucent
Metal - Metallizzato / Silver - Metallized
Nero - Metallizzato / Black - Metallized

OPZIONALE OPTIONAL

CODICE CODE

DESCRIZIONE DESCRIPTION

160976 Kit di sospensione con rosone traslucido, cavo acciaio e cavo alimentazione 2x0,75mm²
Suspension kit with translucent canopy, steel wire, supply cable 2x0,75mm²



7558-00-31 Adattatore elettromeccanico LKM 6A bianco
White LKM electro/mechanical adapter 6A



7558-00-30 Adattatore elettromeccanico LKM 6A nero
Black LKM electro/mechanical adapter 6A



CODICE CODE

DESCRIZIONE DESCRIPTION

7618-00-31 Adattatore meccanico bianco con bloccacavo
White mechanical adapter with locking device



7618-00-30 Adattatore meccanico nero con bloccacavo
Black mechanical adapter with locking device





Faretti da esterno

Exterior luminaires

Il rigoroso design della gamma di luci da esterno si armonizza con la morbidezza della luce emanata, valorizzando percorsi, architetture e spazi all'aperto. Caratterizzati da un'estetica minimal, garantiscono un'ottima qualità della luce ovunque siano collocati.

Una gamma di prodotti completa e caratterizzata da semplicità geometrica e tratti sinuosi che si adatta ad applicazioni anche in interni.

The rigorous design of this range of exterior luminaires harmonizes with the softness of the light, enhancing paths, architectures and outdoor spaces. Featuring a minimal design, they offer excellent quality of light wherever they are placed. They are a complete range of products featuring geometric simplicity and sinuous lines that are well suited also for indoor applications.

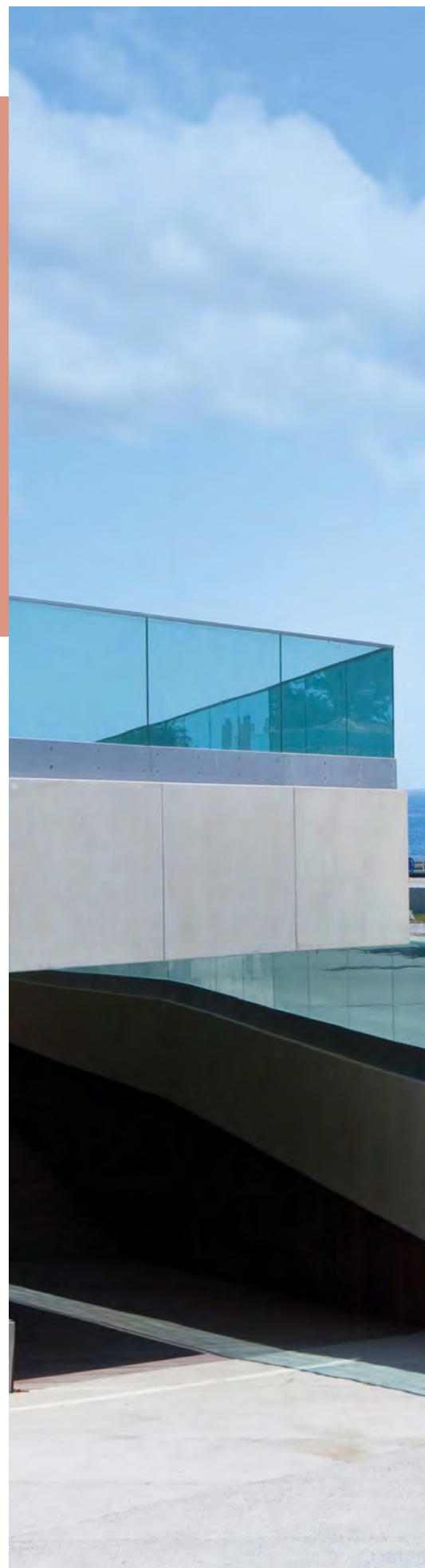



Semplice come la luce

Simple as light

La semplicità di installazione e l'alta resistenza, favorita anche dallo speciale trattamento antiossidante e dalle guarnizioni silconiche, li rendono prodotti decisamente efficienti e versatili.

The easiness of installation and high resistance, thanks to the special antioxidant treatment and silicone gaskets, make them very efficient and versatile products.





La gamma di faretti da esterno si compone di incassi a parete o a pavimento, anche carrabili, proiettori e plafoniere.

The exterior luminaires range features ingrounds, also suitable for vehicles traffic, recessed wall lights, floodlights and ceiling lights.

GLEN 36T

Incasso soffitto
Ceiling recessed

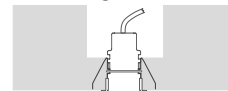

Scheda tecnica
Datasheet

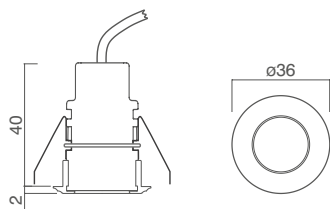

IP67

500 mA

ALIMENTATORE NON INCLUSO
DRIVER NOT INCLUDED
misure in mm / measurements in mm

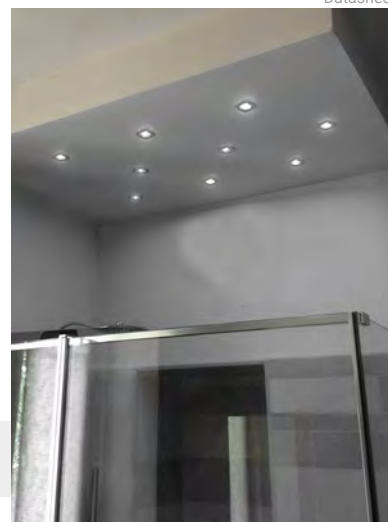

Configuratore di riferimento:
Reference configurator:

Es: G36T-C1

Acciaio/termoplastica
Steel/thermoplastic

CE IP67

COMPOSIZIONE CODICE CODE COMPOSITION

COD.BASE BASE CODE:	COLORE LED LED COLOR	OTTICA OPTICS
G36T-	Z (bianco 2700K/white 2700K)	1 (14°)
	C (bianco 3000K/white 3000K)	3 (30°)
	N (bianco 4000K/white 4000K)	4 (45°)
		8 (asimmetrico/ asymmetrical)

DATI TECNICI TECHNICAL DATA

LUMEN	WATT	CRI
233	1,5	90
245	1,5	90
252	1,5	90

DRIVER DA ORDINARE SEPARATAMENTE DRIVER TO ORDER SEPARATELY

mA	On/Off	DALI *	1.10V/PUSH *
500	03153 max. 7 spot	03152 max. 11 spot	03150 max. 14 spot

* l'alimentatore non si adatta al foro del soffitto.
* The power supply does not fit into the ceiling hole.

ACCESSORI

ACCESSORIES

10064-F

Mini connettore 2 poli IP68 femmina
IP68 female 2 pole mini connector

10064-M

Mini connettore 2 poli IP68 maschio
IP68 male 2 pole mini connector

GLEN 36TC

Incasso calpestabile
Walkable recessed

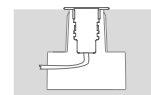

Scheda tecnica
Datasheet

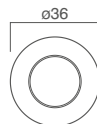
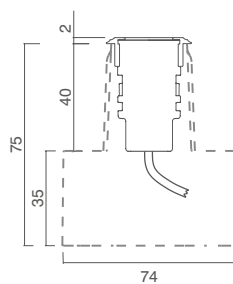

IP67

500 mA

***CASSAFORMA INCLUSA**
cod.11034
***FORMWORK INCLUDED**
code 11034

ALIMENTATORE NON INCLUSO
DRIVER NOT INCLUDED

misure in mm / measurements in mm



Configuratore di riferimento:
Reference configurator:

Es: G36TC-C1

■ Acciaio/termoplastica
Steel/thermoplastic

CE IP67

COMPOSIZIONE CODICE CODE COMPOSITION

COD.BASE BASE CODE:	COLORE LED LED COLOR	OTTICA OPTICS
G36TC-	Z (bianco 2700K/white 2700K)	1 (14°)
	C (bianco 3000K/white 3000K)	3 (30°)
	N (bianco 4000K/white 4000K)	4 (45°)
		8 (asimmetrico/ asymmetrical)

DATI TECNICI TECHNICAL DATA

LUMEN	WATT	CRI
233	1,5	90
245	1,5	90
252	1,5	90

DRIVER DA ORDINARE SEPARATAMENTE DRIVER TO ORDER SEPARATELY

mA	On/Off	DALI	1.10V/PUSH
500	03022 max. 4 spot	03152 max. 11 spot	03150 max. 14 spot

ACCESSORI

ACCESSORIES

10064-F

Mini connettore 2 poli IP68 femmina
IP68 female 2 pole mini connector

10064-M

Mini connettore 2 poli IP68 maschio
IP68 male 2 pole mini connector

GLEN 36Q

Incasso soffitto
Ceiling recessed



Scheda tecnica
Datasheet

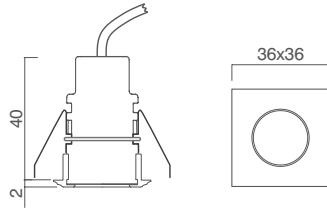

IP67 
500 mA



ALIMENTATORE NON INCLUSO
DRIVER NOT INCLUDED
misure in mm / measurements in mm

 Acciaio/termoplastica
Steel/thermoplastic

CE IP67

COMPOSIZIONE CODICE CODE COMPOSITION

COD.BASE BASE CODE:	COLORE LED LED COLOR	OTTICA OPTICS
G36Q-	Z (bianco 2700K/white 2700K)	1 (14°)
	C (bianco 3000K/white 3000K)	3 (30°)
	N (bianco 4000K/white 4000K)	4 (45°)
		8 (asimmetrico/ asymmetrical)

DATI TECNICI TECHNICAL DATA

LUMEN	WATT	CRI
233	1,5	90
245	1,5	90
252	1,5	90

Configuratore di riferimento:
Reference configurator:

Es: **G36Q-C1**

DRIVER DA ORDINARE SEPARATAMENTE DRIVER TO ORDER SEPARATELY

mA	On/Off	DALI *	1.10V/PUSH *
500	03153 max. 7 spot	03152 max. 11 spot	03150 max. 14 spot

* l'alimentatore non si adatta al foro del soffitto.
* The power supply does not fit into the ceiling hole.

ACCESSORI

ACCESSORIES

10064-F

Mini connettore 2 poli IP68 femmina
IP68 female 2 pole mini connector

10064-M

Mini connettore 2 poli IP68 maschio
IP68 male 2 pole mini connector

GLEN 36QC

Incasso calpestabile
Walkable recessed

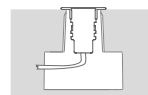

Scheda tecnica
Datasheet

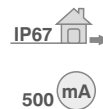
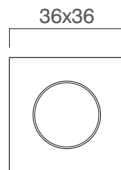
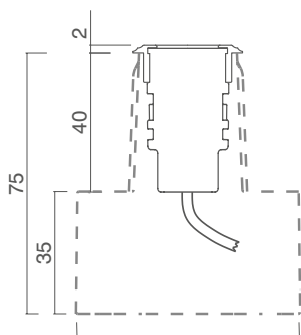

***CASSAFORMA INCLUSA**
cod.11034
***FORMWORK INCLUDED**
code 11034

ALIMENTATORE NON INCLUSO
DRIVER NOT INCLUDED

misure in mm / measurements in mm

■ Acciaio/termoplastica
Steel/thermoplastic

IP67



Configuratore di riferimento:
Reference configurator:

Es: G36QC-C1

COMPOSIZIONE CODICE CODE COMPOSITION

COD.BASE BASE CODE:	COLORE LED LED COLOR	OTTICA OPTICS
G36QC-	Z (bianco 2700K/white 2700K)	1 (14°)
	C (bianco 3000K/white 3000K)	3 (30°)
	N (bianco 4000K/white 4000K)	4 (45°)
		8 (asimmetrico/ asymmetrical)

DATI TECNICI TECHNICAL DATA

LUMEN	WATT	CRI
233	1,5	90
245	1,5	90
252	1,5	90

DRIVER DA ORDINARE SEPARATAMENTE DRIVER TO ORDER SEPARATELY

mA	On/Off	DALI	1.10V/PUSH
500	03022 max. 4 spot	03152 max. 11 spot	03150 max. 14 spot

ACCESSORI

ACCESSORIES

10064-F

Mini connettore 2 poli IP68 femmina
IP68 female 2 pole mini connector

10064-M

Mini connettore 2 poli IP68 maschio
IP68 male 2 pole mini connector

DEMA 45T

Incasso soffitto
Ceiling recessed



Scheda tecnica
Datasheet

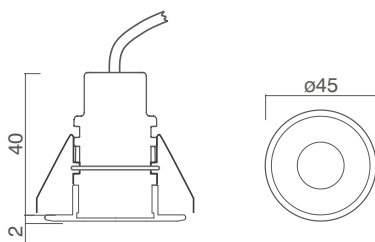

IP67

500 mA



ALIMENTATORE NON INCLUSO
DRIVER NOT INCLUDED
misure in mm / measurements in mm

Acciaio/termoplastica
Steel/thermoplastic

CE IP67

COMPOSIZIONE CODICE CODE COMPOSITION

COD.BASE BASE CODE:	COLORE LED LED COLOR	OTTICA OPTICS
D45T-	Z (bianco 2700K/white 2700K)	1 (14°)
	C (bianco 3000K/white 3000K)	3 (30°)
	N (bianco 4000K/white 4000K)	4 (45°)
		8 (asimmetrico/ asymmetrical)

DATI TECNICI TECHNICAL DATA

LUMEN	WATT	CRI
233	1,5	90
245	1,5	90
252	1,5	90

Configuratore di riferimento:
Reference configurator:

Es: D45T-C4

DRIVER DA ORDINARE SEPARATAMENTE DRIVER TO ORDER SEPARATELY

mA	On/Off	DALI *	1.10V/PUSH *
500	03153 max. 7 spot	03152 max. 11 spot	03150 max. 14 spot

* l'alimentatore non si adatta al foro del soffitto.
* The power supply does not fit into the ceiling hole.

ACCESSORI

ACCESSORIES

10064-F

Mini connettore 2 poli IP68 femmina
IP68 female 2 pole mini connector

10064-M

Mini connettore 2 poli IP68 maschio
IP68 male 2 pole mini connector

DEMA 45TC

Incasso calpestabile
Walkable recessed

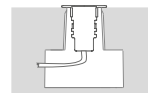

Scheda tecnica
Datasheet

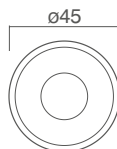
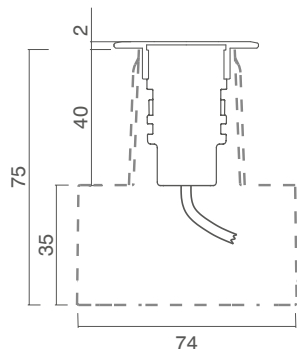

IP67

500 mA

CASSAFORMA INCLUSA
cod.11034
FORMWORK INCLUDED
code 11034

ALIMENTATORE NON INCLUSO
DRIVER NOT INCLUDED

misure in mm / measurements in mm



Configuratore di riferimento:
Reference configurator:

Es: D45TC-C4

Acciaio/termoplastica
Steel/thermoplastic

CE IP67

COMPOSIZIONE CODICE CODE COMPOSITION

COD.BASE BASE CODE:	COLORE LED LED COLOR	OTTICA OPTICS
D45TC-	Z (bianco 2700K/white 2700K)	1 (14°)
	C (bianco 3000K/white 3000K)	3 (30°)
	N (bianco 4000K/white 4000K)	4 (45°)
		8 (asimmetrico/ asymmetrical)

DATI TECNICI TECHNICAL DATA

LUMEN	WATT	CRI
233	1,5	90
245	1,5	90
252	1,5	90

DRIVER DA ORDINARE SEPARATAMENTE DRIVER TO ORDER SEPARATELY

mA	On/Off	DALI	1.10V/PUSH
500	03022 max. 4 spot	03152 max. 11 spot	03150 max. 14 spot

ACCESSORI

ACCESSORIES

10064-F

Mini connettore 2 poli IP68 femmina
IP68 female 2 pole mini connector

10064-M

Mini connettore 2 poli IP68 maschio
IP68 male 2 pole mini connector

DEMA 45Q

Incasso soffitto
Ceiling recessed



Scheda tecnica
Datasheet

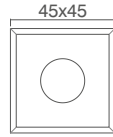
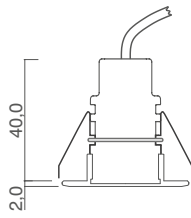

IP67

500 mA

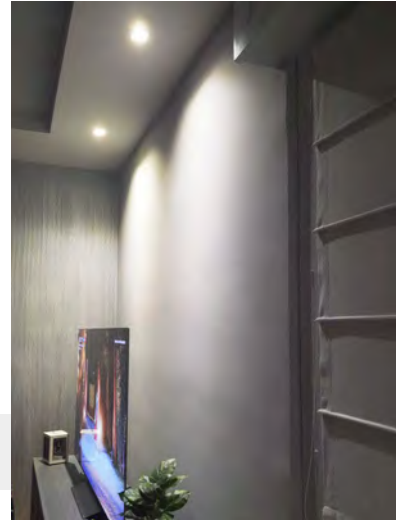

ALIMENTATORE NON INCLUSO
DRIVER NOT INCLUDED
misure in mm / measurements in mm

Acciaio/termoplastica
Steel/thermoplastic

CE IP67

COMPOSIZIONE CODICE CODE COMPOSITION

COD.BASE BASE CODE:	COLORE LED LED COLOR	OTTICA OPTICS
D45Q-	Z (bianco 2700K/white 2700K)	1 (14°)
	C (bianco 3000K/white 3000K)	3 (30°)
	N (bianco 4000K/white 4000K)	4 (45°)
		8 (asimmetrico/ asymmetrical)

DATI TECNICI TECHNICAL DATA

LUMEN	WATT	CRI
233	1,5	90
245	1,5	90
252	1,5	90

Configuratore di riferimento:
Reference configurator:
Es: D45Q-C4

DRIVER DA ORDINARE SEPARATAMENTE DRIVER TO ORDER SEPARATELY

mA	On/Off	DALI *	1.10V/PUSH *
500	03153 max. 7 spot	03152 max. 11 spot	03150 max. 14 spot

* l'alimentatore non si adatta al foro del soffitto.
* The power supply does not fit into the ceiling hole.

ACCESSORI

ACCESSORIES

10064-F

Mini connettore 2 poli IP68 femmina
IP68 female 2 pole mini connector

10064-M

Mini connettore 2 poli IP68 maschio
IP68 male 2 pole mini connector

DEMA 45QC

Incasso calpestabile
Walkable recessed

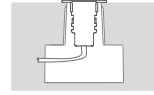

Scheda tecnica
Datasheet

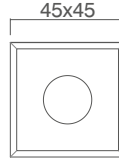
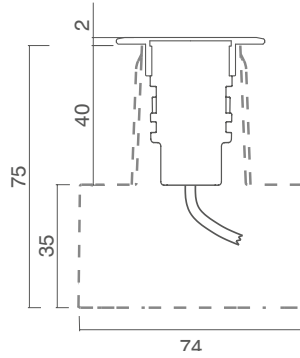

IP67 
500 mA

CASSAFORMA INCLUSA
cod.11034
FORMWORK INCLUDED
code 11034

ALIMENTATORE NON INCLUSO
DRIVER NOT INCLUDED
misure in mm / measurements in mm

 Acciaio/termoplastica
Steel/thermoplastic

 **CE** **IP67**

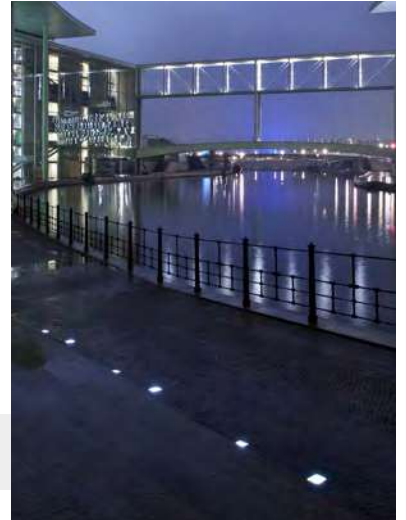

Configuratore di riferimento:
Reference configurator:

Es: D45QC-C4

COMPOSIZIONE CODICE CODE COMPOSITION

COD.BASE BASE CODE:	COLORE LED LED COLOR	OTTICA OPTICS
D45QC-	Z (bianco 2700K/white 2700K)	1 (14°)
	C (bianco 3000K/white 3000K)	3 (30°)
	N (bianco 4000K/white 4000K)	4 (45°)
		8 (asimmetrico/ asymmetrical)

DATI TECNICI TECHNICAL DATA

LUMEN	WATT	CRI
233	1,5	90
245	1,5	90
252	1,5	90

DRIVER DA ORDINARE SEPARATAMENTE DRIVER TO ORDER SEPARATELY

mA	On/Off	DALI	1.10V/PUSH
500	03022 max. 4 spot	03152 max. 11 spot	03150 max. 14 spot

ACCESSORI

ACCESSORIES

10064-F

Mini connettore 2 poli IP68 femmina
IP68 female 2 pole mini connector

10064-M

Mini connettore 2 poli IP68 maschio
IP68 male 2 pole mini connector

BRIXIA 50E

Incasso calpestabile
Walkable Recessed



Scheda tecnica
Datasheet

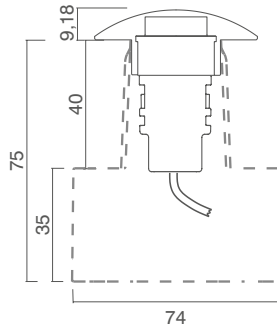

CASSAFORMA INCLUSA
cod.11034
FORMWORK INCLUDED
code 11034

ALIMENTATORE NON INCLUSO
DRIVER NOT INCLUDED
misure in mm / measurements in mm

Acciaio/termoplastica
Steel/thermoplastic

Emissione laterale
Lateral emission

CE IP67

COMPOSIZIONE CODICE
CODE COMPOSITION

COD.BASE COLORE LED
BASE CODE: LED COLOR

BX50E- **Z** (bianco 2700K/white 2700K)
 C (bianco 3000K/white 3000K)
 N (bianco 4000K/white 4000K)

DATI TECNICI
TECHNICAL DATA

LUMEN	WATT	CRI
58	1,5	90
61	1,5	90
63	1,5	90

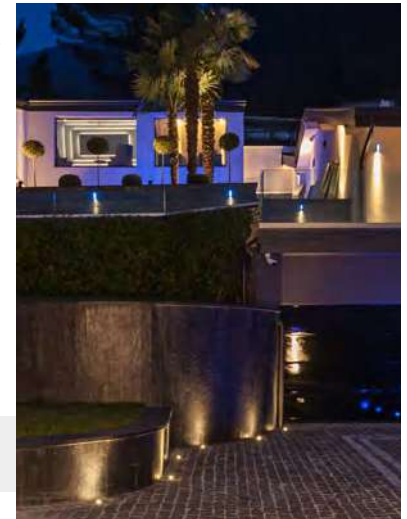

Configuratore di riferimento:
Reference configurator:

Es: **BX50E-C**

DRIVER DA ORDINARE SEPARATAMENTE
DRIVER TO ORDER SEPARATELY

mA	On/Off	DALI	1.10V/PUSH
500	03022 max. 4 spot	03152 max. 11 spot	03150 max. 14 spot

ACCESSORI

ACCESSORIES

10064-F

Mini connettore 2 poli IP68 femmina
IP68 female 2 pole mini connector

10064-M

Mini connettore 2 poli IP68 maschio
IP68 male 2 pole mini connector

VERONA 50E

Incasso calpestabile
Walkable Recessed



Scheda tecnica
Datasheet

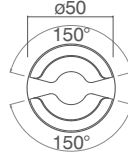
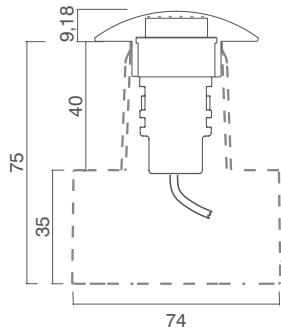

IP67

500 mA

CASSAFORMA INCLUSA
cod.11034
FORMWORK INCLUDED
code 11034

ALIMENTATORE NON INCLUSO
DRIVER NOT INCLUDED
misure in mm / measurements in mm



■ Acciaio/termoplastica
Steel/thermoplastic

Biemissione orizzontale
Horizontal double emission

IP67

COMPOSIZIONE CODICE
CODE COMPOSITION

COD.BASE **COLORE LED**
BASE CODE: LED COLOR

VN50E- **Z** (bianco 2700K/white 2700K)
 C (bianco 3000K/white 3000K)
 N (bianco 4000K/white 4000K)

DATI TECNICI
TECHNICAL DATA

LUMEN	WATT	CRI
58	1,5	90
61	1,5	90
63	1,5	90

Configuratore di riferimento:
Reference configurator:

Es: VN50E-C

DRIVER DA ORDINARE SEPARATAMENTE
DRIVER TO ORDER SEPARATELY

mA	On/Off	DALI	1.10V/PUSH
500	03022 max. 4 spot	03152 max. 11 spot	03150 max. 14 spot

ACCESSORI

ACCESSORIES

10064-F

Mini connettore 2 poli IP68 femmina
IP68 female 2 pole mini connector

10064-M

Mini connettore 2 poli IP68 maschio
IP68 male 2 pole mini connector

VENEZIA 50E

Incasso calpestabile
Walkable Recessed



Scheda tecnica
Datasheet

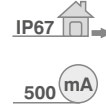
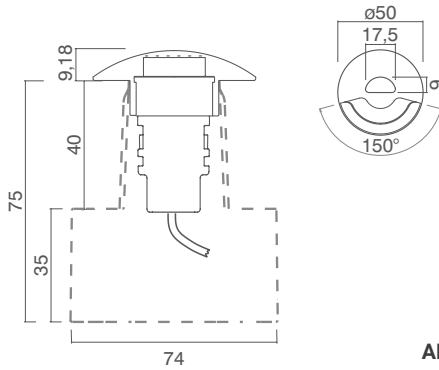

CASSAFORMA INCLUSA
cod.11034
FORMWORK INCLUDED
code 11034

ALIMENTATORE NON INCLUSO
DRIVER NOT INCLUDED
misure in mm / measurements in mm

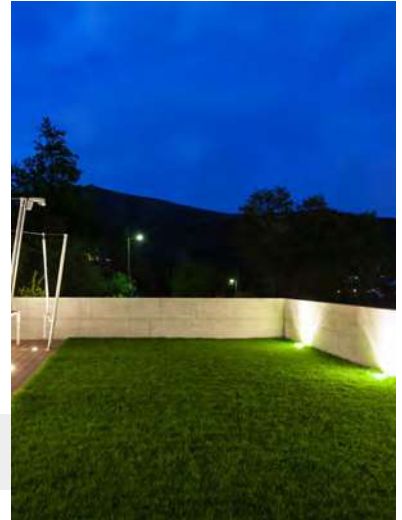

■ Acciaio/termoplastica
Steel/thermoplastic

Emissione orizzontale+verticale
Horizontal+vertical emission

CE **IP67**

COMPOSIZIONE CODICE
CODE COMPOSITION

COD.BASE **COLORE LED**
BASE CODE: LED COLOR

VE50E- **Z** (bianco 2700K/white 2700K)
 C (bianco 3000K/white 3000K)
 N (bianco 4000K/white 4000K)

DATI TECNICI
TECHNICAL DATA

LUMEN	WATT	CRI
53	1,5	90
61	1,5	90
63	1,5	90

Configuratore di riferimento:
Reference configurator:

Es: VE50E-C

DRIVER DA ORDINARE SEPARATAMENTE
DRIVER TO ORDER SEPARATELY

mA	On/Off	DALI	1.10V/PUSH
500	03022 max. 4 spot	03152 max. 11 spot	03150 max. 14 spot

ACCESSORI
ACCESSORIES

10064-F
Mini connettore 2 poli IP68 femmina
IP68 female 2 pole mini connector

10064-M
Mini connettore 2 poli IP68 maschio
IP68 male 2 pole mini connector



YOLA 80C

Monoemissione/Single emission

Incasso calpestabile
Walkable Recessed

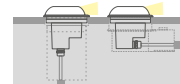

Scheda tecnica
Datasheet

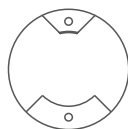
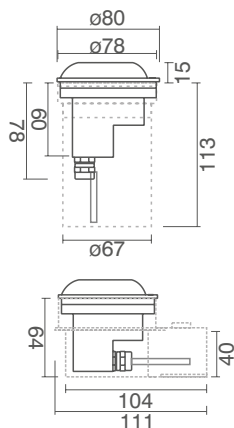

IP67

350 mA

CASSAFORMA INCLUSA

Verticale: cod.10974

Laterale: cod.10973

FORMWORK INCLUDED

Vertical: code 10974

Lateral: code 10973

ALIMENTATORE NON INCLUSO

DRIVER NOT INCLUDED

misure in mm / measurements in mm

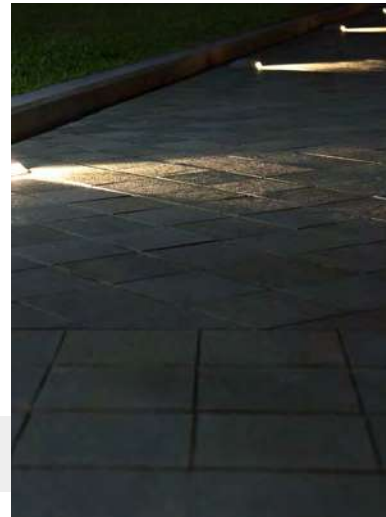

Alluminio
Aluminum

CE IP67

COMPOSIZIONE CODICE

CODE COMPOSITION

COD.BASE
BASE CODE:

COLORE LED
LED COLOR

CASSAFORMA
FORMWORK

DATI TECNICI
TECHNICAL DATA

Y80C-

Z (2700K)
C (3000K)
N (4000K)
F (5800K)
B (blu/blue)
R (rosso/red)
V (verde/green)
X (R+G+B)*

V (verticale/vertical)
L (laterale/lateral)

LUMEN	WATT	CRI
97	3,2	80
105	3,2	80
108	3,2	80

Configuratore di riferimento:
Reference configurator:

Es: Y80C-CV

DRIVER DA ORDINARE SEPARATAMENTE

DRIVER TO ORDER SEPARATELY

mA	PUSH	1-10V	DALI
350	03150 max. 6 spot	03150 max. 6 spot	03151 max. 6 spot

OPZIONALE

OPTIONAL

09010

CTRL CC 3CH RGB+RC 220VAC max.10W/CH*

TAYLOR 80C

Biemissione/BiemiSSION

Incasso calpestabile
Walkable Recessed

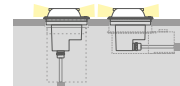

Scheda tecnica
Datasheet

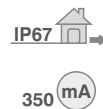
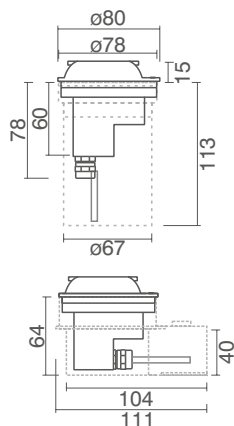

CASSAFORMA INCLUSA

Verticale: cod.10974

Laterale: cod.10973

FORMWORK INCLUDED

Vertical: code 10974

Lateral: code 10973

ALIMENTATORE NON INCLUSO

DRIVER NOT INCLUDED

misure in mm / measurements in mm

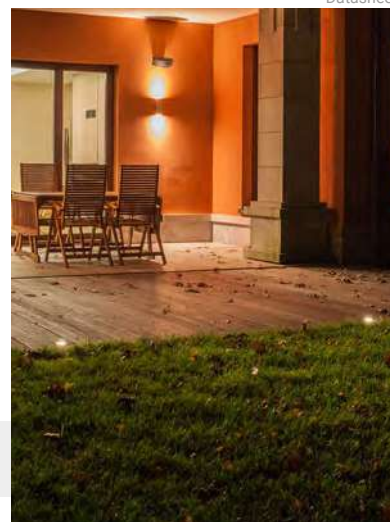

Alluminio
Aluminum

CE IP67

COMPOSIZIONE CODICE

CODE COMPOSITION

COD.BASE
BASE CODE:

COLORE LED
LED COLOR

CASSAFORMA
FORMWORK

DATI TECNICI
TECHNICAL DATA

T80C-
Z (2700K)
C (3000K)
N (4000K)
F (5800K)
B (blu/blue)
R (rosso/red)
V (verde/green)
X (R+G+B)*

V (verticale/vertical)
L (laterale/lateral)

LUMEN	WATT	CRI
97	3,2	80
105	3,2	80
108	3,2	80

Configuratore di riferimento:
Reference configurator:

Es: T80C-CV

DRIVER DA ORDINARE SEPARATAMENTE

DRIVER TO ORDER SEPARATELY

mA	PUSH	1-10V	DALI
350	03150 max. 6 spot	03150 max. 6 spot	03151 max. 6 spot

OPZIONALE

OPTIONAL

09010

CTRL CC 3CH RGB+RC 220VAC max.10W/CH*

ARMENIA 80C

10 raggi/10 beams

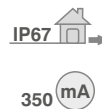
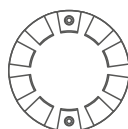
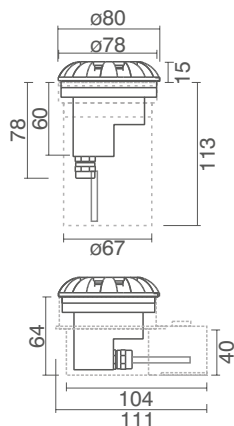

Incasso calpestabile
Walkable Recessed

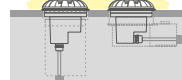

Scheda tecnica
Datasheet

CASSAFORMA INCLUSA

Verticale: cod.10974

Laterale: cod.10973

FORMWORK INCLUDED

Vertical: code 10974

Lateral: code 10973

ALIMENTATORE NON INCLUSO

DRIVER NOT INCLUDED

misure in mm / measurements in mm



Alluminio
Aluminum



COMPOSIZIONE CODICE

CODE COMPOSITION

COD.BASE
BASE CODE:

COLORE LED
LED COLOR

CASSAFORMA
FORMWORK

DATI TECNICI
TECHNICAL DATA

A80C-
Z (2700K)
C (3000K)
N (4000K)
F (5800K)
B (blu/blue)
R (rosso/red)
V (verde/green)
X (R+G+B)*

V (verticale/vertical)
L (laterale/lateral)

LUMEN	WATT	CRI
97	3,2	80
105	3,2	80
108	3,2	80

Configuratore di riferimento:
Reference configurator:

Es: A80C-CV

DRIVER DA ORDINARE SEPARATAMENTE

DRIVER TO ORDER SEPARATELY

mA	PUSH	1-10V	DALI
350	03150 max. 6 spot	03150 max. 6 spot	03151 max. 6 spot

OPZIONALE

OPTIONAL

09010

CTRL CC 3CH RGB+RC 220VAC max.10W/CH*

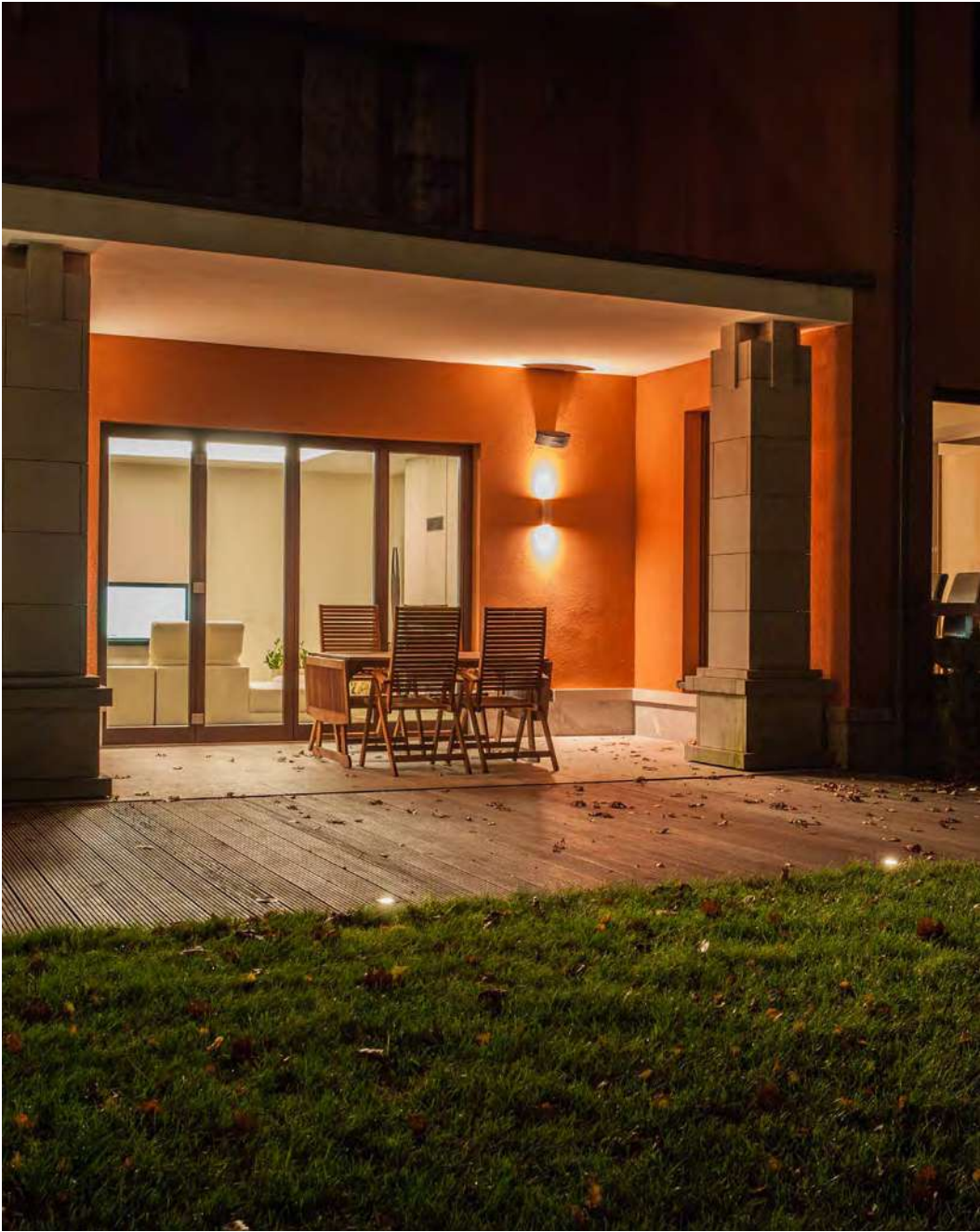

BAXTER 85C

Incasso calpestabile
Walkable Recessed



Scheda tecnica
Datasheet

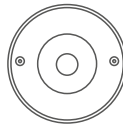
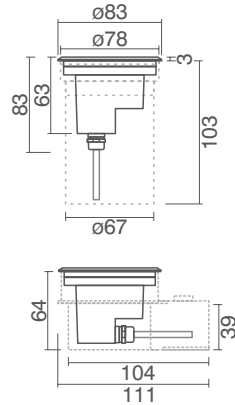

IP67
350 mA

CASSAFORMA INCLUSA
Verticale: cod.10974
Laterale: cod.10973
FORMWORK INCLUDED
Vertical: code 10974
Lateral: code 10973

ALIMENTATORE NON INCLUSO
DRIVER NOT INCLUDED
misure in mm / measurements in mm

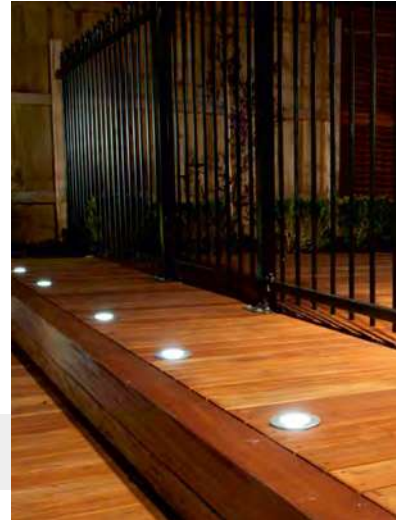

Alluminio + acciaio
Aluminum + steel

CE IP67

COMPOSIZIONE CODICE CODE COMPOSITION

COD.BASE BASE CODE:	COLORE LED LED COLOR	OTTICA OPTICS	CASSAFORMA FORMWORK
B85C-	Z (2700K)	1 (10°)	V (verticale/vertical)
	C (3000K)	2 (25°)	L (laterale/lateral)
	N (4000K)	4 (40°)	
	F (5800K)		
	B (blu/blue)		
	R (rosso/red)		
	V (verde/green)		
	X (R+G+B)*		

DATI TECNICI TECHNICAL DATA

LUMEN	WATT	CRI
456	3,2	80
456	3,2	80
489	3,2	80
528	3,2	80

Configuratore di riferimento:
Reference configurator:
Es: B85C-C1V

DRIVER DA ORDINARE SEPARATAMENTE DRIVER TO ORDER SEPARATELY

mA	PUSH	1-10V	DALI
350	03150 max. 6 spot	03150 max. 6 spot	03151 max. 6 spot

OPZIONALE OPTIONAL

09010
CTRL CC 3CH RGB+RC 220VAC max.10W/CH*

BAXTER 83C

Incasso calpestabile
Walkable Recessed



Scheda tecnica
Datasheet

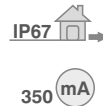
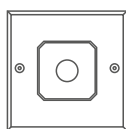
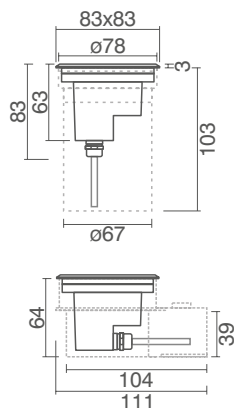

CASSAFORMA INCLUSA

Verticale: cod.10974

Laterale: cod.10973

FORMWORK INCLUDED

Vertical: code 10974

Lateral: code 10973

ALIMENTATORE NON INCLUSO

DRIVER NOT INCLUDED

misure in mm / measurements in mm



Configuratore di riferimento:
Reference configurator:

Es: B83C-C1V

Alluminio + acciaio
Aluminum + steel

CE IP67

COMPOSIZIONE CODICE

CODE COMPOSITION

COD.BASE **COLORE LED**
BASE CODE: LED COLOR

OTTICA
OPTICS

CASSAFORMA
FORMWORK

DATI TECNICI
TECHNICAL DATA

B83C-
Z (2700K)
C (3000K)
N (4000K)
F (5800K)
B (blu/blue)
R (rosso/red)
V (verde/green)
X (R+G+B)*

1 (10°)
2 (25°)
4 (40°)

V (verticale/vertical)
L (laterale/lateral)

LUMEN	WATT	CRI
456	3,2	80
456	3,2	80
489	3,2	80
528	3,2	80

DRIVER DA ORDINARE SEPARATAMENTE

DRIVER TO ORDER SEPARATELY

mA	PUSH	1-10V	DALI
350	03150 max. 6 spot	03150 max. 6 spot	03151 max. 6 spot

OPZIONALE

OPTIONAL

09010

CTRL CC 3CH RGB+RC 220VAC max.10W/CH*



IP68
3mt

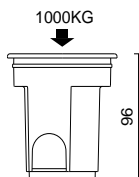
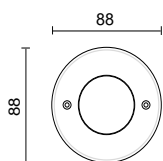

CONTROCASSA IN DOTAZIONE
ALIMENTATORE NON INCLUSO
RECESSED HOUSING INCLUDED - DRIVER
NOT INCLUDED

misure in mm / measurements in mm

CE **IP68 IK10**
3mt



CODICE
CODE

DATI TECNICI
TECHNICAL DATA

	LUMEN	WATT	mA VDC	CCT (K)	CRI	T MAX (°C)
1563180	300 - (3 LED)	3	350	3000	80	55°
1543180	180 - (9 LED)	1,5	24	3500	80	40°
1546480	180 - (9 LED)	1,5	24	Blu / Blue	-	40°

DRIVER DA ORDINARE SEPARATAMENTE
DRIVER TO BE ORDERED SEPARATELY

mA	Constant current	
350	81-04020	Distanza massima dal driver 30 mt Max distance from driver 30mt

DRIVER DA ORDINARE SEPARATAMENTE
DRIVER TO BE ORDERED SEPARATELY

Vdc	Constant current	
24	81-04006	Distanza massima dal driver 30 mt Max distance from driver 30mt

OPZIONALE
OPTIONAL

CODICE CODE	DESCRIZIONE DESCRIPTION	
160821	10 mt bobina cavo alimentazione H05RN-F 2x1mm ² 10 mt supply cable coil H05RN-F 2x1mm ²	
84108	Connettore stagno Rated cable connector	

WALKER LED

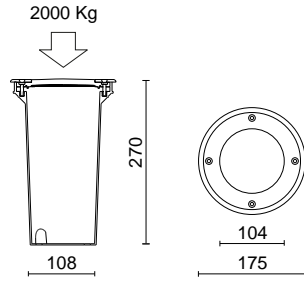

IP67

Incasso calpestabile
Walkable Recessed



Scheda tecnica
Datasheet

REGOLABILE SULLA FASE
CONTROCASSA IN DOTAZIONE
DIMMABLE ON THE MAINS - RECES-
SED HOUSING INCLUDED

misure in mm / measurements in mm

CE **IP67 IK10**

230/240V - 50/60Hz



CODICE
CODE

DATI TECNICI
TECHNICAL DATA

1553181

LUMEN	WATT	CCT (K)	CRI	T MAX (°C)	OTTICA OPTIC
367	6,5	3000	80	60°	100°

OPZIONALE: vedi pag. a sinistra
OPTIONAL: see left page

WALKER

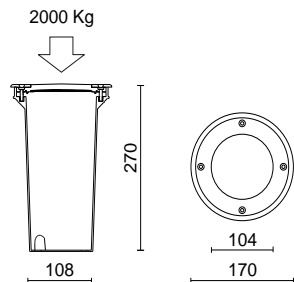

IP67

Incasso calpestabile
Walkable Recessed



Scheda tecnica
Datasheet

CONTROCASSA IN DOTAZIONE
LAMPADA NON INCLUSA
RECESSED HOUSING INCLUDED
LAMP NOT INCLUDED

misure in mm / measurements in mm

CE **IP67 IK10**

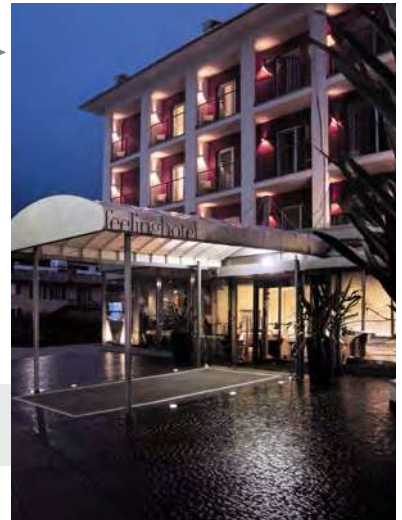

CODICE
CODE

DATI TECNICI
TECHNICAL DATA

155180

LAMPADA LAMP	WATT	ATTACCO BASE	T MAX (°C)
IRR63/LED	max 40	E27	100°

OPZIONALE: vedi pag. a sinistra
OPTIONAL: see left page

BAXTER 175

Incasso calpestabile
Walkable Recessed



Scheda tecnica
Datasheet

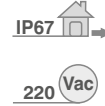
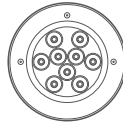
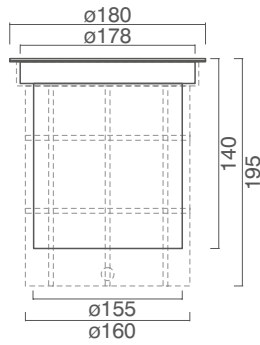

CASSAFORMA INCLUSA cod.10976
FORMWORK INCLUDED code 10976

ALIMENTATORE INCLUSA
DRIVER INCLUDED

misure in mm / measurements in mm

Alluminio + acciaio
Aluminum + steel

IP67



Configuratore di riferimento:
Reference configurator:

Es: B175-N4

COMPOSIZIONE CODICE CODE COMPOSITION

COD.BASE **COLORE LED**
BASE CODE: LED COLOR

OTTICA
OPTICS

DATI TECNICI
TECHNICAL DATA

B175- **C** (bianco 3000K/white 3000K)
 N (bianco 4000K/white 4000K)
 F (bianco 5800K/white 5800K)
 B (blu/blue)
 R (rosso/red)
 V (verde/green)
 X (R+G+B)*

1 (10°)
2 (25°)
4 (40°)

LUMEN	WATT	CRI
1170	10,8	80
1260	10,8	80
1305	10,8	80

* Alimentatore e controller 350mA non compresi

OPZIONALE OPTIONAL

09254
DRIVER 350-1050mA 40W DALI-PUSH IP20 MW

03230
DRIVER 350-1050mA 40W 1..10V IP20 MW

09010
CTRL CC 3CH RGB+RC 220VAC max.10W/CH*

Accessori da utilizzare in applicazione remota con settaggio a 350mA (esterni al faretto)
Accessories to be used in remote application with setting at 350mA (external to the spotlight)

ACHILLE 190 LED



2000 Kg - max 40 km/h

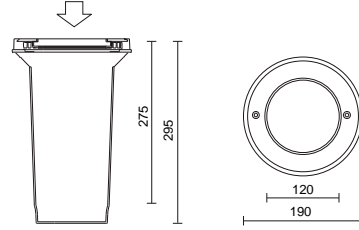

IP67

Incasso calpestabile
Walkable Recessed



Scheda tecnica
Datasheet

OTTICA ORIENTABILE +/-7°
CONTROCASSA IN DOTAZIONE
+/-7° ADJUSTABLE REFLECTOR - RECESSED
HOUSING INCLUDED

misure in mm / measurements in mm

CE **IP67 IK10**

220/240V - 50/60Hz

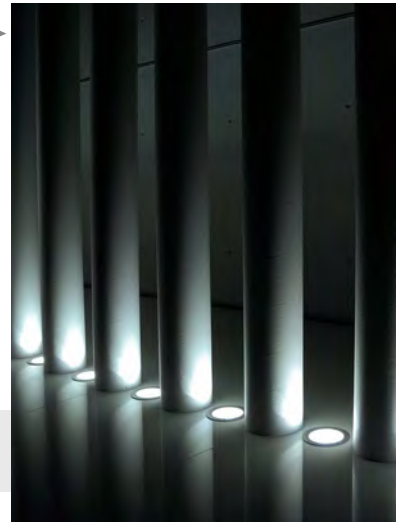

CODICE
CODE

DATI TECNICI
TECHNICAL DATA

	LUMEN	WATT	CCT (K)	CRI	T MAX (°C)	OTTICA OPTIC
149401	1530	12	3000	85	40°	26°
149501	2125	18	3000	85	40°	26°

12W: regolabile sulla fase / dimmable on the mains

OPZIONALE
OPTIONAL

CODICE CODE	DESCRIZIONE DESCRIPTION		CODICE CODE	DESCRIZIONE DESCRIPTION	
28-9001-51	Ottica professionale S - fascio 15° Professional optic device S - beam 15°		160821	10 mt bobina cavo alimentazione H05RN-F 2x1mm² 10mt supply cable coil H05RN-F 2x1mm²	
28-9003-51	Ottica professionale W - fascio 45° Professional optic device W - beam 45°				

Ottiche non pre-montate
Not pre-assembled optics

ACHILLE 320 LED

Incasso calpestabile
Walkable Recessed



Scheda tecnica
Datasheet

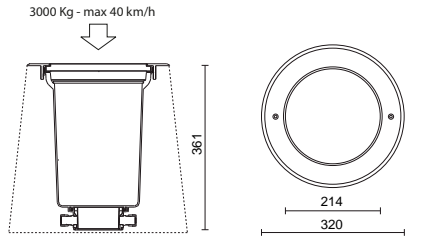

IP67



OTTICA ORIENTABILE +/-15°
CONTROCASSA DA ORDINARE SEPARATAMENTE
+/-15° ADJUSTABLE REFLECTOR
RECESSED HOUSING TO BE ORDERED SEPARATELY

misure in mm / measurements in mm

CE IP67 IK10

220/240V - 50/60Hz

CODICE
CODE

DATI TECNICI
TECHNICAL DATA

	LUMEN	WATT	CCT (K)	CRI	T MAX (°C)	OTTICA OPTIC
147900	1944	18	3000	85	35°	30°
148000	3190	27	3000	85	35°	25°
146200	3344	32	3000	85	35°	30°
146300	4121	36	3000	85	35°	25°

OPZIONALE OPTIONAL

CODICE CODE	DESCRIZIONE DESCRIPTION	
28-3140-51	Ottica professionale S: fascio 17° (18W/32W) / fascio 25° (27W/36W) Professional optic device S: beam 17° (18W/32W) / beam 25° (27W/36W)	
28-3142-51	Ottica professionale M: fascio 30° (18W/32W) / fascio 40° (27W/36W) Professional optic device M: beam 30° (18W/32W) / beam 40° (27W/36W)	
28-3138-51	Ottica professionale W: fascio 55° (18W/32W) / fascio 60° (27W/36W) Professional optic device W: beam 55° (18W/32W) / beam 60° (27W/36W)	
28-3141-31	Ottica professionale XW - fascio 70° Professional optic device XW - beam 70°	

Ottiche non pre-montate
Not pre-assembled optics

CODICE CODE	DESCRIZIONE DESCRIPTION	
28-3957-30	Cilindro antiabbagliamento Snoot	
28-3959-30	Frangiluce alveolare (da utilizzare con cod. 28-3957-30) Honeycomb (to be used with code 28-3957-30)	
160348	Controcassa Recessed housing	

STILLED

Incasso calpestabile
Walkable Recessed



Scheda tecnica
Datasheet

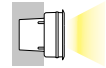

IP66

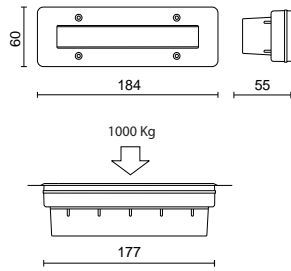

CONTROCASSA IN DOTAZIONE
ALIMENTATORE NON INCLUSO
RECESSED HOUSING INCLUDED
DRIVER NOT INCLUDED

misure in mm / measurements in mm

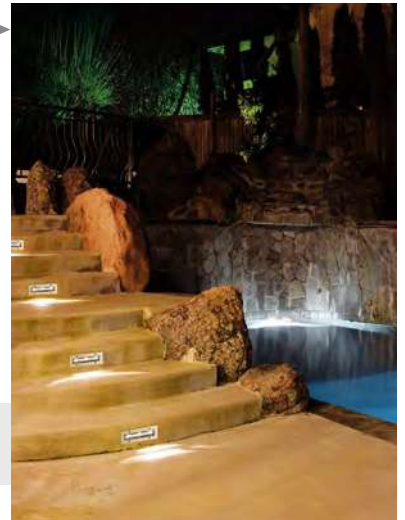

CE IP66 IK10

CODICE
CODE

DATI TECNICI
TECHNICAL DATA

	LUMEN	WATT	mA Vdc	CCT (K)	CRI	T MAX (°C)
1583180	300	3	350	3000	80	55°
1513180	200	1,3	24	3500	80	40°

DRIVER DA ORDINARE SEPARATAMENTE
DRIVER TO BE ORDERED SEPARATELY

mA	Constant current	
350	81-04020	Distanza massima dal driver 30 mt Max distance from driver 30mt

DRIVER DA ORDINARE SEPARATAMENTE
DRIVER TO BE ORDERED SEPARATELY

Vdc	Constant current	
24	81-04006	Distanza massima dal driver 30 mt Max distance from driver 30mt

OPZIONALE
OPTIONAL

CODICE CODE	DESCRIZIONE DESCRIPTION	
160821	10 mt bobina cavo alimentazione H05RN-F 2x1mm ² 10mt supply cable coil H05RN-F 2x1mm ²	
84108	Connettore stagno Rated cable connector	

SERIE 500

Incasso a muro
Wall recessed



Scheda tecnica
Datasheet



IP65

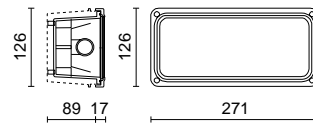

CONTROCASSA IN DOTAZIONE
RECESSED HOUSING INCLUDED

misure in mm / measurements in mm

Bianco
White

Nero
Black

Grigio
Grey

CE **IP65 IK08**

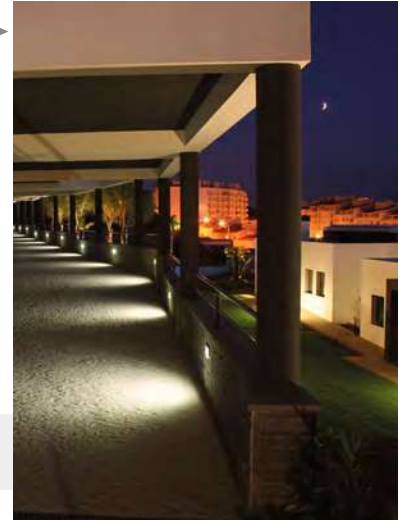

CODICE
CODE

DATI TECNICI
TECHNICAL DATA

CODICE CODE	LAMPADA LAMP	WATT	ATTACCO BASE	FINITURA FINISH
150000	HE	60	E27	Nero / Black
150001	HE	60	E27	Bianco / White
150002	HE	60	E27	Grigio / Grey

SERIE 500

CON GRIGLIA / WITH GRID

Incasso a muro
Wall recessed



Scheda tecnica
Datasheet



IP65

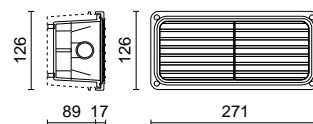

CONTROCASSA IN DOTAZIONE
RECESSED HOUSING INCLUDED

misure in mm / measurements in mm

Nero
Black

CE **IP65 IK08**



CODICE
CODE

DATI TECNICI
TECHNICAL DATA

CODICE CODE	LAMPADA LAMP	WATT	ATTACCO BASE	FINITURA FINISH
150400	HE	40	E27	Nero / Black



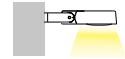

IP67

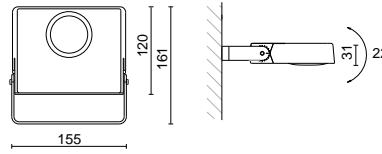

OTTICA ORIENTABILE +/-7°
CONTROCASSA IN DOTAZIONE
+/-7° ADJUSTABLE REFLECTOR - RECESSED
HOUSING INCLUDED

misure in mm / measurements in mm

Nero
Black Metal
Silver

CE **IP67 IK10**

220/240V - 50/60Hz

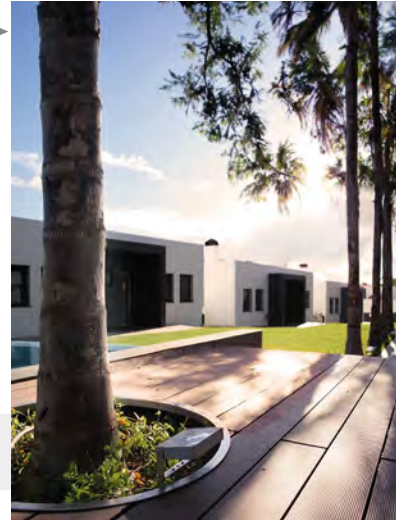

CODICE
CODE

DATI TECNICI
TECHNICAL DATA

	LUMEN	WATT	CCT (K)	CRI	OTTICA OPTIC	FINITURA FINISH
11200030	1486	12	3000	85	30°	Nero / Black
11200085	1486	12	3000	85	30°	Metal / Silver

OPZIONALE
OPTIONAL

CODICE CODE	DESCRIZIONE DESCRIPTION
84108	Connettore stagno Rated cable connector



LITO 230

Proiettore
Floodlight

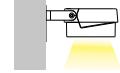

Scheda tecnica
Datasheet

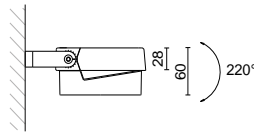
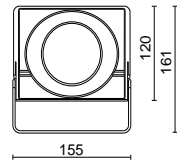

IP66

**PRETRATTAMENTO ANTIOSSIDANTE E
VERNICIATURA POLIESTERE
ANTI-OXIDIZING PRETREATMENT
AND POLYESTER PAINTING**

misure in mm / measurements in mm

Nero
Black

CE **IP66 IK10**

220/240V - 50/60Hz



CODICE
CODE

DATI TECNICI
TECHNICAL DATA

	LUMEN	WATT	CCT (K)	CRI	OTTICA OPTIC	FINITURA FINISH
11430230	1567	12	3000	85	30°	Nero / Black
11430285	1567	12	3000	85	30°	Metal / Silver

OPZIONALE OPTIONAL

CODICE CODE	DESCRIZIONE DESCRIPTION		CODICE CODE	DESCRIZIONE DESCRIPTION	
28-3140-51	Ottica professionale S - fascio 12° Professional optic device S - beam 12°		28-3959-30	Frangiluce alveolare (da utilizzare con cod. 28-3957-30) Honeycomb (to be used with code 28-3957-30)	
28-3138-51	Ottica professionale W - fascio 55° Professional optic device W - beam 55°		84108	Connettore stagno Rated cable connector	
28-3141-31	Ottica professionale XW - fascio 70° Professional optic device XW - beam 70°				

Ottiche non pre-montate
Not pre-assembled optics

MAXILITO

Proiettore
Floodlight



Scheda tecnica
Datasheet

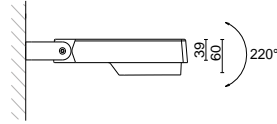
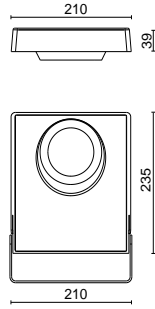

IP66

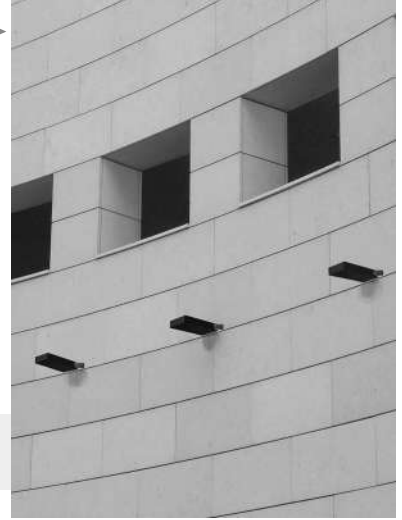

ALIMENTATORE INCLUSO
DRIVER INCLUDED

misure in mm / measurements in mm

■ Nero
Black ■ Metal
Silver

CE **IP66 IK10**

220/240V - 50/60Hz

CODICE
CODE

DATI TECNICI
TECHNICAL DATA

	LUMEN	WATT	CCT (K)	CRI	OTTICA OPTIC	FINITURA FINISH
11461130	5775	51	3000	85	30°	Nero / Black
11461185	5775	51	3000	85	30°	Metal / Silver

OPZIONALE OPTIONAL

CODICE CODE	DESCRIZIONE DESCRIPTION		CODICE CODE	DESCRIZIONE DESCRIPTION	
28-3140-51	Ottica professionale S - fascio 12° Professional optic device S - beam 12°		28-4019-30	Frangiluce alveolare Honeycomb	
28-3138-51	Ottica professionale W - fascio 55° Professional optic device W - beam 55°		84108	Connettore stagno Rated cable connector	
28-3141-31	Ottica professionale XW - fascio 70° Professional optic device XW - beam 70°				

Ottiche non pre-montate
Not pre-assembled optics

DEDO 100

Proiettore
Floodlight



Scheda tecnica
Datasheet

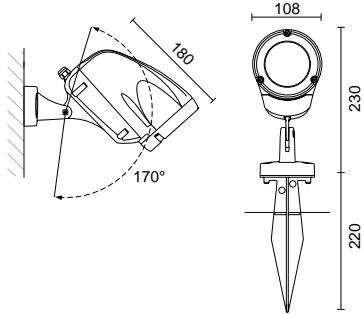

IP66

**CORPO IN TERMOPLASTICO AD ALTA
RESISTENZA RINFORZATO
FIBRA DI VETRO**
**HOUSING IN HIGH RESISTANT THERMOPLASTIC,
REINFORCED WITH FIBER GLASS**

misure in mm / measurements in mm



Nero
Black Grigio
Grey

CE **IP66 IK08**

220/240V - 50/60Hz

CODICE
CODE

DATI TECNICI
TECHNICAL DATA

	LUMEN	WATT	CCT (K)	CRI	OTTICA OPTIC	FINITURA FINISH
111801	1428	12	3000	85	30°	Nero / Black
111802	1428	12	3000	85	30°	Grigio / Grey

OPZIONALE OPTIONAL

CODICE CODE	DESCRIZIONE DESCRIPTION		CODICE CODE	DESCRIZIONE DESCRIPTION	
28-9001-51	Ottica professionale S - fascio 15° Professional optic device S - beam 15°		160821	10 mt bobina cavo alimentazione H05RN-F 2x1mm ² 10mt supply cable coil H05RN-F 2x1mm ²	
28-9003-51	Ottica professionale W - fascio 45° Professional optic device W - beam 45°		84108	Connettore stagno Rated cable connector	
28-3141-31	Ottica professionale XW - fascio 70° Professional optic device XW - beam 70°				

Ottiche non pre-montate
Not pre-assembled optics

NIGEL 202 - RGB+W

Proiettore
Floodlight



Scheda tecnica
Datasheet

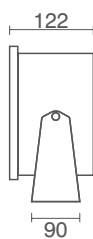
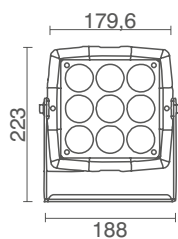

IP65

220 Vac

ALIMENTATORE INCLUSO (infrarosso)
DRIVER INCLUDED (infrared)

misure in mm / measurements in mm



Alluminio
Aluminum

OTTICA 25°
OPTICS 25°

CE IP65

COMPOSIZIONE CODICE
CODE COMPOSITION

COD.BASE
BASE CODE:

NG202-HC2

DATI TECNICI
TECHNICAL DATA

WATT
65

LUMEN
Rosso/Red 443
Verde/Green 1135
Blu/Blue 264
Bianco/White 1150

CONTROLLO E PROGRAMMI
CONTROL AND PROGRAMS

- 3 Variabili di configurazione DMX: 4/6/7 canali
- Password per blocco display
- Protocollo USITT DMX 512
- Master/Slave
- Auto mode

- 3 DMX configuration variables: 4/6/7 channels
- Password for display lock
- USITT DMX 512 protocol
- Master/Slave
- Auto mode

OPZIONALE
OPTIONAL

09085
CTRL DMX512 GENERATOR + RC RGBW 12~24V

09042
TOUCH PANEL 503 DMX512 RGBW 12~24V

09324
SPLITTER DMX512 2CH 12~24V

09330
TOUCH RGBW 4 ZONE

NIGEL 250 - RGB+W

Proiettore
Floodlight



Scheda tecnica
Datasheet

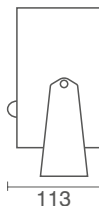
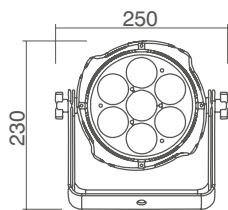

IP65

220 Vac

ALIMENTATORE INCLUSO
DRIVER INCLUDED
misure in mm / measurements in mm



Alluminio
Aluminum

UV LED

OTTICA 25°
OPTICS 25°

CE IP65

COMPOSIZIONE CODICE
CODE COMPOSITION

COD.BASE
BASE CODE:

NG250R-HC2

DATI TECNICI
TECHNICAL DATA

WATT
53

LUMEN
Rosso/Red 357
Verde/Green 927
Blu/Blue 214
Bianco/White 940

CONTROLLO E PROGRAMMI
CONTROL AND PROGRAMS

- 4 Variabili di configurazione DMX: 3/6/8/13 canali
- Password per blocco display
- Modalità automatica con 21 diversi programmi selezionabili da display con regolazione indipendente della velocità e strobo
- Modalità colore con regolazione del singolo colore con 70 diverse selezioni
- Master/Slave
- 11 sezioni di bilanciamento del bianco
- 4 curve dimmer

- 3 DMX configuration variables: 4/6/7 channels
- Password for display lock
- Automatic mode with 21 different programs selectable from the display with independent speed and strobe adjustment
- Color mode with single color adjustment with 70 different selections
- 11 white balance sections
- 4 dimmer curves

OPZIONALE
OPTIONAL

09085
CTRL DMX512 GENERATOR + RC RGBW 12~24V

09042
TOUCH PANEL 503 DMX512 RGBW 12~24V

09324
SPLITTER DMX512 2CH 12~24V

09330
TOUCH RGBW 4 ZONE

NIGEL BAR 965 - RGB+W

Proiettore
Floodlight



Scheda tecnica
Datasheet



IP65

220 Vac



ALIMENTATORE INCLUSO
DRIVER INCLUDED

misure in mm / measurements in mm

Alluminio
Aluminum

OTTICA 15°
OPTICS 15°

CE IP65



COMPOSIZIONE CODICE CODE COMPOSITION

COD.BASE
BASE CODE:

NG965B-HC1

DATI TECNICI TECHNICAL DATA

WATT
108

LUMEN
Rosso/Red 646
Verde/Green 1073
Blu/Blue 255
Bianco/White 1047

CONTROLLO E PROGRAMMI CONTROL AND PROGRAMS

- 7 configurazioni DMX disponibili: 3/4/7/8/10/16/20 canali
- Protocollo USITT DMX 512
- Master/Slave
- Modalità colore statico
- Modalità automatica con 5 diversi programmi selezionabili dal display
- Modalità effetto con 8 diversi programmi selezionabili da display
- Modalità colore con 6 diversi programmi selezionabili da display
- 4 curve dimmer

- 7 DMX configurations available: 3/4/7/8/10/16/20 channels
- USITT DMX 512 protocol
- Master/Slaves
- Static color mode
- Automatic mode with 5 different programs selectable from the display
- Effect mode with 8 different programs selectable from the display
- Color mode with 6 different programs selectable from the display
- 4 dimmer curves

OPZIONALE OPTIONAL

09085
CTRL DMX512 GENERATOR + RC RGBW 12~24V

09042
TOUCH PANEL 503 DMX512 RGBW 12~24V

09324
SPLITTER DMX512 2CH 12~24V

09330
TOUCH RGBW 4 ZONE





IP65

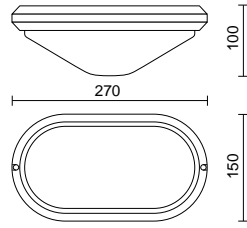

CORPO IN NYLON F.V.30%
DIFFUSORE IN POLICARBONATO
BODY IN NYLON F.G.30%
POLYCARBONATE DIFFUSER

misure in mm / measurements in mm

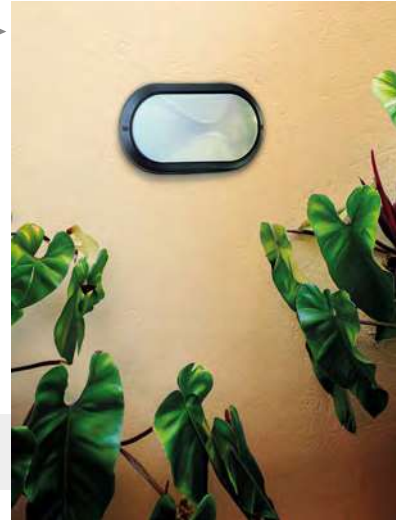

Bianco
White

Nero
Black

Grigio
Grey

CE **IP65 IK10**

CODICE
CODE

DATI TECNICI
TECHNICAL DATA

127300
127301
127302

LAMPADA
LAMP

HE 60W/FBT 11W
HE 60W/FBT 11W
HE 60W/FBT 11W

ATTACCO
BASE

E27
E27
E27

FINITURA
FINISH

Nero / Black
Bianco / White
Grigio / Grey

OPZIONALE
OPTIONAL

CODICE
CODE

DESCRIZIONE
DESCRIPTION

160909

Staffa 45.2 in termoplastico nero
Black thermoplastic bracket 45.2



270P

Plafone
Ceiling



Scheda tecnica
Datasheet



IP65

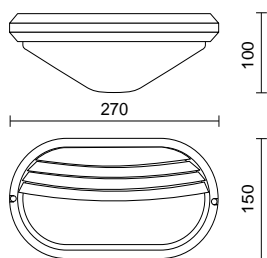

CORPO IN NYLON F.V.30%
DIFFUSORE IN POLICARBONATO
+/-7° BODY IN NYLON F.G.30%
POLYCARBONATE DIFFUSER

misure in mm / measurements in mm



Bianco White Nero Black Grigio Grey

CE **IP65 IK10**

CODICE
CODE

DATI TECNICI
TECHNICAL DATA

	LAMPADA LAMP	ATTACCO BASE	FINITURA FINISH
127000	HE 60W/FBT 11W	E27	Nero / Black
127001	HE 60W/FBT 11W	E27	Bianco / White
127002	HE 60W/FBT 11W	E27	Grigio / Grey

330

Plafone
Ceiling



Scheda tecnica
Datasheet



IP65

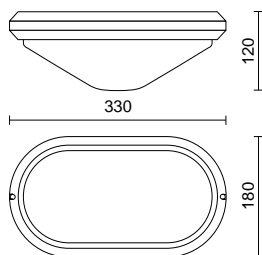

CORPO IN NYLON F.V.30%
DIFFUSORE IN POLICARBONATO
RECESBODY IN NYLON F.G.30%
POLYCARBONATE DIFFUSER

misure in mm / measurements in mm



Bianco White Nero Black

CE **IP65 IK10**

CODICE
CODE

DATI TECNICI
TECHNICAL DATA

	LAMPADA LAMP	ATTACCO BASE	FINITURA FINISH
133400	HE 75W/FBT 15W	E27	Bianco / White
133401	HE 75W/FBT 15W	E27	Nero / Black

250T

Plafone
Ceiling



Scheda tecnica
Datasheet

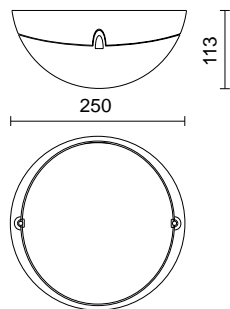

IP66

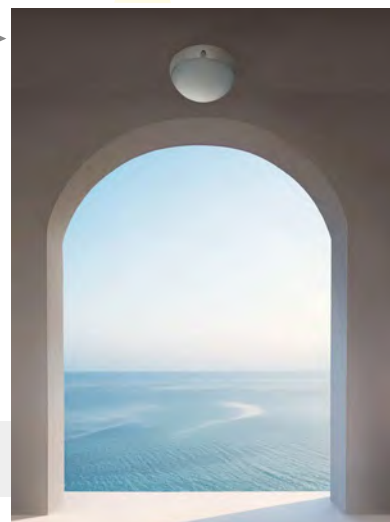

CORPO IN NYLON F.V.30%
DIFFUSORE IN POLICARBONAT
BODY IN NYLON F.G.30%
POLYCARBONATE DIFFUSER

misure in mm / measurements in mm

Bianco
White

CE **IP66 IK10**

230/240V - 50/60Hz

CODICE
CODE

DATI TECNICI
TECHNICAL DATA

137000

LAMPADA
LAMP

HE 60W/FBT 11W

ATTACCO
BASE

E27

FINITURA
FINISH

Bianco / White

270T

Plafone
Ceiling



Scheda tecnica
Datasheet

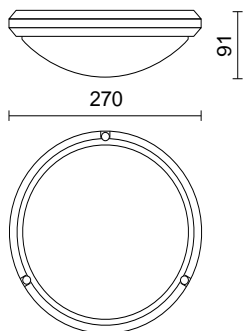

IP66



CORPO IN NYLON F.V.30%
DIFFUSORE IN POLICARBONATO
BODY IN NYLON F.G.30%
POLYCARBONATE DIFFUSER

misure in mm / measurements in mm

Bianco
White

Nero
Black

CE **IP66 IK10**

CODICE
CODE

DATI TECNICI
TECHNICAL DATA

127400
127401

LAMPADA
LAMP

HE 75W/FBT 11W

HE 75W/FBT 11W

ATTACCO
BASE

E27

E27

FINITURA
FINISH

Bianco / White

Nero / Black

270TP

Plafone
Ceiling



Scheda tecnica
Datasheet

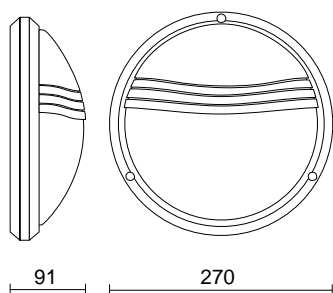

IP66

CORPO IN NYLON F.V.30%
DIFFUSORE IN POLICARBONATO
BODY IN NYLON F.G.30%
POLYCARBONATE DIFFUSER

misure in mm / measurements in mm



Bianco
White

Nero
Black

CE

CODICE
CODE

DATI TECNICI
TECHNICAL DATA

	LAMPADA LAMP	ATTACCO BASE	FINITURA FINISH
126600	HE 40W/FBT 11W	E27	Bianco / White
126601	HE 40W/FBT 11W	E27	Nero / Black

312T

Plafone
Ceiling



Scheda tecnica
Datasheet

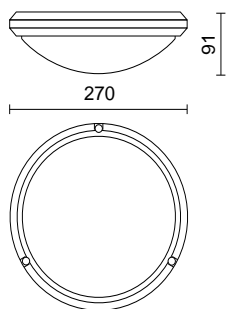

IP65

CORPO IN NYLON F.V.30%
DIFFUSORE IN POLICARBONATO
REBODY IN NYLON F.G.30%
POLYCARBONATE DIFFUSER

misure in mm / measurements in mm



Bianco
White

CE

CODICE
CODE

DATI TECNICI
TECHNICAL DATA

	LAMPADA LAMP	ATTACCO BASE	FINITURA FINISH
136010	HE 75W/FBT21W	E27	Bianco / White

340T

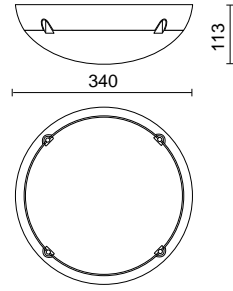

Plafone
Ceiling



Scheda tecnica
Datasheet

IP66 



CORPO IN NYLON F.V.30%
DIFFUSORE IN POLICARBONATO
BODY IN NYLON F.G.30%
POLYCARBONATE DIFFUSER

misure in mm / measurements in mm

Bianco
White

CE    IP66 IK10

CODICE
CODE

DATI TECNICI
TECHNICAL DATA

134000

LAMPADA
LAMP
HE 100W/FBT 21W

ATTACCO
BASE
E27

FINITURA
FINISH
Bianco / White

380T

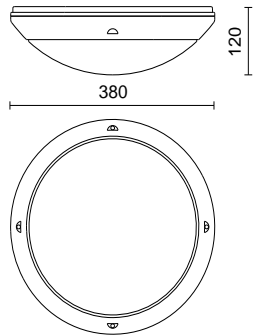

IP66

Plafone
Ceiling

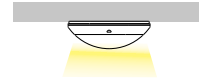

Scheda tecnica
Datasheet



CONTROCASSA IN DOTAZIONE
RECESSED HOUSING INCLUDED

misure in mm / measurements in mm

Bianco
White

CE IP66 IK10

CODICE
CODE

DATI TECNICI
TECHNICAL DATA

142000

LAMPADA
LAMP

HE 100W/FBT 21W

ATTACCO
BASE

E27

FINITURA
FINISH

Bianco / White

380T LED

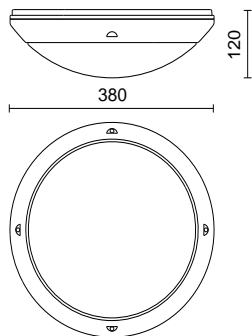

IP65

Plafone
Ceiling

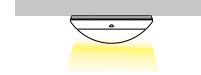

Scheda tecnica
Datasheet



CORPO IN NYLON F.V.30%
DIFFUSORE IN POLICARBONATO
BODY IN NYLON F.G.30%
POLYCARBONATE DIFFUSER

misure in mm / measurements in mm

Bianco
White

CE IP65 IK10

CODICE
CODE

DATI TECNICI
TECHNICAL DATA

142300

LUMEN
1702

WATT
18

CCT (K)
3000

CRI
85

FINITURA
FINISHES
Bianco / White

1423A00

1738

18

4000

85

Bianco / White

142200

2402

26

3000

85

Bianco / White

142600

1702

18

3000

85

Bianco / White

Emergenza 3h / Emergency 3h





Pannelli

LED panels

Una vastissima gamma di forme geometriche piane, illuminate da sorgenti LED. Prodotti super sottili caratterizzati da un'emissione di luce diffusa e omogenea. La linea di pannelli Elcom è disponibile nelle versioni standard e custom, personalizzabili a seconda dell'esigenza di spazio e illuminazione richiesti. Sono disponibili in diverse modalità di installazione; a sospensione, a incasso o a plafone, adattandosi a tutti i progetti di illuminazione.

A wide range of flat geometric shapes, illuminated by LED sources. Super thin products characterized by a diffused and homogeneous light emission. The Elcom line of panels is available in standard and custom versions, customizable according to the need for space and lighting required. They are available in different installation modes; suspended, recessed or ceiling mounted, adapting to all lighting projects.

BACKLIGHT 60-60

595 X 595 X h25 mm



Scheda tecnica
Datasheet

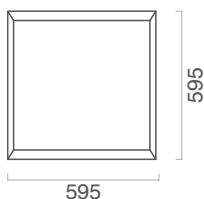

misure in mm / measurements in mm

UGR<19

IP40



CODICE: CODE: ON/OFF	CODICE: CODE: 1-10 V	CODICE: CODE: DALI/PUSH	CCT (K)	CRI	W	Flusso luminoso reale (lm) Real luminous flux (lm)
15246-IO	15246-AN	15246-DP	3000	90	40	3800 lm
15247-IO	15247-AN	15247-DP	4000	90	40	4180 lm
15248-IO	15248-AN	15248-DP	5800	90	40	4180 lm

OPZIONALE OPTIONAL

18026
Case a plafone 68mm
Ceiling case 68mm

18027
Cornice incasso
Recessed frame

18125
Kit attacco binario
Track attachment kit

ZQ04-04R0 (INCASSO/RECESSED)*
Sensore di luminosità e movimento
DALI/Wireless
Light and motion sensor DALI/Wireless

ZQ16-00R0 (PLAFONE/CEILING)*
Sensore di luminosità e movimento
DALI/Wireless
Light and motion sensor DALI/Wireless

07550
Inverter+batteria per emergenza
Inverter+battery for emergency

10037
Cavo di sincronizzazione L=2m (Solo per 1-10V e Dali/Push)
Sync cable L=2m (Only for 1-10V and Dali/Push)

10036
Cavo di sincronizzazione L=3m (Solo per 1-10V e Dali/Push)
Sync cable L=3m (Only for 1-10V and Dali/Push)

10043
Cavo di sincronizzazione L=5m (Solo per 1-10V e Dali/Push)
Sync cable L=5m (Only for 1-10V and Dali/Push)

*Abbinabile ai pannelli in versione
DALI/PUSH

*Can be combined with the version panels
DALI/PUSH

BACKLIGHT 120-30

1195 X 295 X h25 mm



Scheda tecnica
Datasheet

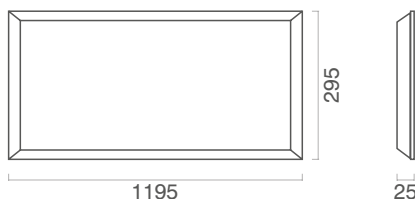

misure in mm / measurements in mm

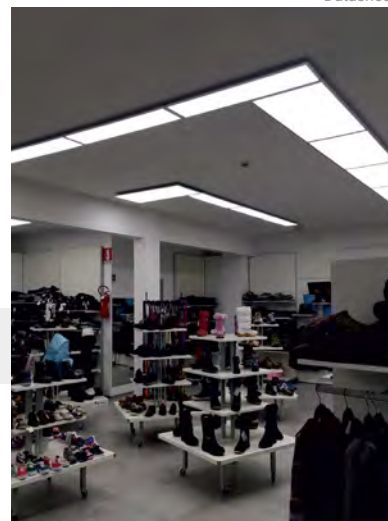

UGR<19

IP40

CODICE: CODE: ON/OFF	CODICE: CODE: 1-10 V	CODICE: CODE: DALI/PUSH	CCT (K)	CRI	W	Flusso luminoso reale (lm) Real luminous flux (lm)
15264-IO	15264-AN	15264-DP	3000	90	40	3800 lm
15265-IO	15265-AN	15265-DP	4000	90	40	4180 lm
15266-IO	15266-AN	15266-DP	5800	90	40	4180 lm

OPZIONALE OPTIONAL

18028
Case a plafone 68mm
Ceiling case 68mm

18029
Cornice incasso
Recessed frame

18135
Kit attacco binario
Track attachment kit

ZQ04-04R0 (INCASSO/RECESSED)*
Sensore di luminosità e movimento
DALI/Wireless
Light and motion sensor DALI/Wireless

ZQ16-00R0 (PLAFONE/CEILING)*
Sensore di luminosità e movimento
DALI/Wireless
Light and motion sensor DALI/Wireless

07550
Inverter+batteria per emergenza
Inverter+battery for emergency

10037
Cavo di sincronizzazione L=2m (Solo per 1-10V e Dali/Push)
Sync cable L=2m (Only for 1-10V and Dali/Push)

10036
Cavo di sincronizzazione L=3m (Solo per 1-10V e Dali/Push)
Sync cable L=3m (Only for 1-10V and Dali/Push)

10043
Cavo di sincronizzazione L=5m (Solo per 1-10V e Dali/Push)
Sync cable L=5m (Only for 1-10V and Dali/Push)

*Abbinabile ai pannelli in versione
DALI/PUSH
*Can be combined with the version panels
DALI/PUSH

BACKLIGHT 120-60

1195 X 595 X h30 mm



Scheda tecnica
Datasheet

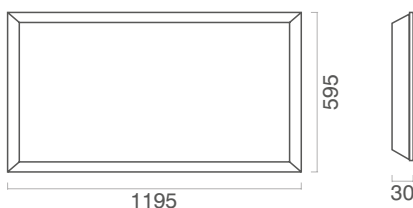

misure in mm / measurements in mm



UGR19

IP40

CODICE: CODE: ON/OFF	CODICE: CODE: 1-10 V	CODICE: CODE: DALI/PUSH	CCT (K)	CRI	W	Flusso luminoso reale (lm) Real luminous flux (lm)
15249-IO	15249-AN	15249-DP	3000	90	60	6000 lm
15254-IO	15254-AN	15254-DP	4000	90	60	6200 lm

OPZIONALE OPTIONAL

18044
Case a plafone 68mm
Ceiling case 68mm

18005
Cornice incasso
Recessed frame

ZQ04-04R0 (INCASSO/RECESSED)*
Sensore di luminosità e movimento
DALI/Wireless

Light and motion sensor DALI/Wireless

ZQ16-00R0 (PLAFONE/CEILING)*
Sensore di luminosità e movimento
DALI/Wireless

Light and motion sensor DALI/Wireless

07550
Inverter+batteria per emergenza
Inverter+battery for emergency

10037
Cavo di sincronizzazione L=2m (Solo per 1-10V e Dali/Push)
Sync cable L=2m (Only for 1-10V and Dali/Push)

10036
Cavo di sincronizzazione L=3m (Solo per 1-10V e Dali/Push)
Sync cable L=3m (Only for 1-10V and Dali/Push)

10043
Cavo di sincronizzazione L=5m (Solo per 1-10V e Dali/Push)
Sync cable L=5m (Only for 1-10V and Dali/Push)

*Abbinabile ai pannelli in versione
DALI/PUSH

*Can be combined with the version panels
DALI/PUSH

BACKLIGHT 60-60

595 X 595 X h30 mm



Scheda tecnica
Datasheet

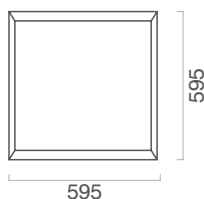

misure in mm / measurements in mm



UGR19

IP65

CODICE: CODE: ON/OFF	CODICE: CODE: 1-10 V	CODICE: CODE: DALI/PUSH	CCT (K)	CRI	W	Flusso luminoso reale (lm) Real luminous flux (lm)
15258-IO	15258-AN	15258-DP	3000	90	50	5000 lm
15257-IO	15257-AN	15257-DP	4000	90	50	5200 lm

OPZIONALE OPTIONAL

18026
Case a plafone 68mm
Ceiling case 68mm

18027
Cornice incasso
Recessed frame

ZQ16-00R0 (PLAFONE/CEILING)*
Sensore di luminosità e movimento
DALI/Wireless

Light and motion sensor DALI/Wireless

07550
Inverter+batteria per emergenza
Inverter+battery for emergency

10037
Cavo di sincronizzazione L=2m (Solo per 1-10V e Dali/Push)
Sync cable L=2m (Only for 1-10V and Dali/Push)

10036
Cavo di sincronizzazione L=3m (Solo per 1-10V e Dali/Push)
Sync cable L=3m (Only for 1-10V and Dali/Push)

10043
Cavo di sincronizzazione L=5m (Solo per 1-10V e Dali/Push)
Sync cable L=5m (Only for 1-10V and Dali/Push)

*Abbinabile ai pannelli in versione
DALI/PUSH
*Can be combined with the version panels
DALI/PUSH

EDGE LIGHT 60-60

595 X 595 X h9,5 mm



Scheda tecnica
Datasheet

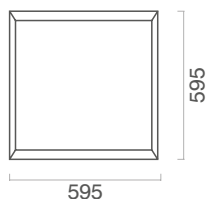

misure in mm / measurements in mm

IP20



CODICE: CODE: ON/OFF	CODICE: CODE: 1-10 V	CODICE: CODE: DALI/PUSH	CCT (K)	CRI	W	Flusso luminoso reale (lm) Real luminous flux (lm)
15000-IO	15000-AN	15000-DP	3000	85	40	3600 lm
15001-IO	15001-AN	15001-DP	4000	85	40	4000 lm
15006-IO	15006-AN	15006-DP	6000	85	40	4000 lm

OPZIONALE OPTIONAL

18031
Case a plafone 50mm
Ceiling case 50mm

18027
Cornice incasso
Recessed frame

15159
Kit sospensione 4 cavi L=1000mm
Suspension kit 4 cables L=1000mm

18125
Kit attacco binario
Track attachment kit

ZQ04-04R0 (INCASSO/RECESSED)*
Sensore di luminosità e movimento
DALI/Wireless

Light and motion sensor DALI/Wireless

ZQ16-00R0 (PLAFONE/CEILING)*
Sensore di luminosità e movimento
DALI/Wireless

Light and motion sensor DALI/Wireless

07550
Inverter+batteria per emergenza
Inverter+battery for emergency

10037
Cavo di sincronizzazione L=2m (Solo per 1-10V e Dali/Push)
Sync cable L=2m (Only for 1-10V and Dali/Push)

10036
Cavo di sincronizzazione L=3m (Solo per 1-10V e Dali/Push)
Sync cable L=3m (Only for 1-10V and Dali/Push)

10043
Cavo di sincronizzazione L=5m (Solo per 1-10V e Dali/Push)
Sync cable L=5m (Only for 1-10V and Dali/Push)

*Abbinabile ai pannelli in versione
DALI/PUSH

*Can be combined with the version panels
DALI/PUSH

EDGE LIGHT 120-30

1195 X 295 X h9,5 mm



Scheda tecnica
Datasheet

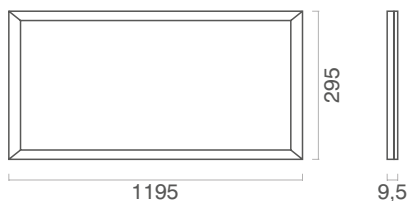

misure in mm / measurements in mm

IP20



CODICE: CODE: ON/OFF	CODICE: CODE: 1-10 V	CODICE: CODE: DALI/PUSH	CCT (K)	CRI	W	Flusso luminoso reale (lm) Real luminous flux (lm)
15030-IO	15030-AN	15030-DP	3000	85	40	3600 lm
15031-IO	15031-AN	15031-DP	4000	85	40	4000 lm
15034-IO	15034-AN	15034-DP	6000	85	40	4000 lm

OPZIONALE OPTIONAL

18032
Case a plafone 50mm
Ceiling case 50mm

18029
Cornice incasso
Recessed frame

15159
Kit sospensione 4 cavi L=1000mm
Suspension kit 4 cables L=1000mm

18135
Kit attacco binario
Track attachment kit

ZQ04-04R0 (INCASSO/RECESSED)*
Sensore di luminosità e movimento
DALI/Wireless

Light and motion sensor DALI/Wireless

ZQ16-00R0 (PLAFONE/CEILING)*
Sensore di luminosità e movimento
DALI/Wireless

Light and motion sensor DALI/Wireless

07550
Inverter+batteria per emergenza
Inverter+battery for emergency

*Abbinabile ai pannelli in versione
DALI/PUSH

*Can be combined with the version panels
DALI/PUSH

10037
Cavo di sincronizzazione L=2m (Solo per 1-10V e Dali/Push)
Sync cable L=2m (Only for 1-10V and Dali/Push)

10036
Cavo di sincronizzazione L=3m (Solo per 1-10V e Dali/Push)
Sync cable L=3m (Only for 1-10V and Dali/Push)

10043
Cavo di sincronizzazione L=5m (Solo per 1-10V e Dali/Push)
Sync cable L=5m (Only for 1-10V and Dali/Push)

EDGE LIGHT 60-30

595 X 295 X h9,5 mm



Scheda tecnica
Datasheet

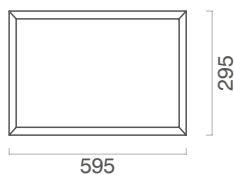

measure in mm / measurements in mm

IP20



CODICE: CODE: ON/OFF	CODICE: CODE: 1-10 V	CODICE: CODE: DALI/PUSH	CCT (K)	CRI	W	Flusso luminoso reale (lm) Real luminous flux (lm)
15050-IO	15050-AN	15050-DP	3000	85	15	1500 lm
15051-IO	15051-AN	15051-DP	4000	85	15	1600 lm
15056-IO	15056-AN	15056-DP	6000	85	15	1600 lm

OPZIONALE OPTIONAL

18033
Case a plafone 50mm
Ceiling case 50mm

18006
Cornice incasso
Recessed frame

15159
Kit sospensione 4 cavi L=1000mm
Suspension kit 4 cables L=1000mm

ZQ04-04R0 (INCASSO/RECESSED)*
Sensore di luminosità e movimento
DALI/Wireless

Light and motion sensor DALI/Wireless

ZQ16-00R0 (PLAFONE/CEILING)*
Sensore di luminosità e movimento
DALI/Wireless

Light and motion sensor DALI/Wireless

07550
Inverter+batteria per emergenza
Inverter+battery for emergency

10037
Cavo di sincronizzazione L=2m (Solo per 1-10V e Dali/Push)
Sync cable L=2m (Only for 1-10V and Dali/Push)

10036
Cavo di sincronizzazione L=3m (Solo per 1-10V e Dali/Push)
Sync cable L=3m (Only for 1-10V and Dali/Push)

10043
Cavo di sincronizzazione L=5m (Solo per 1-10V e Dali/Push)
Sync cable L=5m (Only for 1-10V and Dali/Push)

*Abbinabile ai pannelli in versione
DALI/PUSH

*Can be combined with the version panels
DALI/PUSH



Round $\varnothing 115 \times h 32 \text{mm}$ Incasso/Recessed



Scheda tecnica
Datasheet

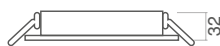
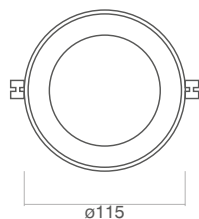

220 Vac

\varnothing 100/110 (mm)

misure in mm / measurements in mm

Bianco
White

IP20/44

CODICE: CODE: ON/OFF	CCT (K)	CRI	W	Flusso luminoso reale (lm) Real luminous flux (lm)
15556-IO	3000	80	6	400 lm
15557-IO	4000	80	6	415 lm

Round $\varnothing 170 \times h 32 \text{mm}$ Incasso/Recessed

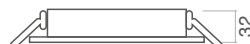
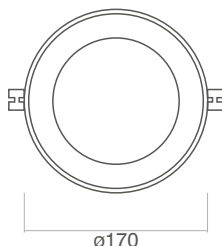

220 Vac

\varnothing 150/160 (mm)

misure in mm / measurements in mm

Bianco
White

IP20/44

CODICE: CODE: ON/OFF	CCT (K)	CRI	W	Flusso luminoso reale (lm) Real luminous flux (lm)
15558-IO	3000	80	12	900 lm
15559-IO	4000	80	12	935 lm

Round $\varnothing 220 \times h 32 \text{mm}$ Incasso/Recessed

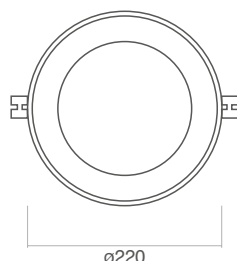

220 Vac

\varnothing 200/210 (mm)

misure in mm / measurements in mm

Bianco
White

IP20/44

CODICE: CODE: ON/OFF	CCT (K)	CRI	W	Flusso luminoso reale (lm) Real luminous flux (lm)
15560-IO	3000	80	18	1430 lm
15561-IO	4000	80	18	1490 lm

Square 115x115xh32mm

Incasso/Recessed



Scheda tecnica
Datasheet

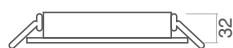
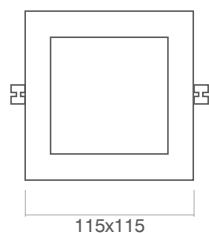

220 (Vac)

100 (mm)
110 (mm)

measure in mm / measurements in mm

Bianco
White

IP20/44

CODICE: CODE: ON/OFF	CCT (K)	CRI	W	Flusso luminoso reale (lm) Real luminous flux (lm)
15562-IO	3000	80	6	400 lm
15563-IO	4000	80	6	415 lm

Square 165x165xh32mm

Incasso/Recessed

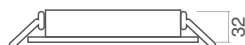
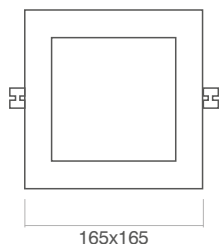

220 (Vac)

150 (mm)
160 (mm)

measure in mm / measurements in mm

Bianco
White

IP20/44

CODICE: CODE: ON/OFF	CCT (K)	CRI	W	Flusso luminoso reale (lm) Real luminous flux (lm)
15564-IO	3000	80	12	900 lm
15565-IO	4000	80	12	935 lm

Square 220x220xh32mm

Incasso/Recessed

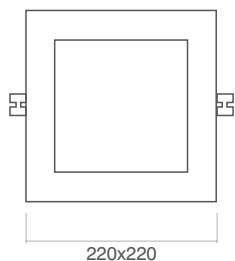

220 (Vac)

200 (mm)
210 (mm)

measure in mm / measurements in mm

Bianco
White

IP20/44

CODICE: CODE: ON/OFF	CCT (K)	CRI	W	Flusso luminoso reale (lm) Real luminous flux (lm)
15566-IO	3000	80	18	1430 lm
15567-IO	4000	80	18	1490 lm

Round $\varnothing 128 \times h 39$ mm

Plafone/Ceiling



Scheda tecnica
Datasheet

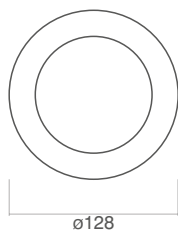

220 Vac

misure in mm / measurements in mm

Bianco
White

IP20/44

CODICE: CODE: ON/OFF	CCT (K)	CRI	W	Flusso luminoso reale (lm) Real luminous flux (lm)
15537-IO	3000	80	6	400 lm
15538-IO	4000	80	6	415 lm

Round $\varnothing 182 \times h 39$ mm

Plafone/Ceiling

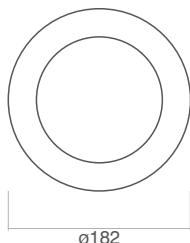

220 Vac

misure in mm / measurements in mm

Bianco
White

IP20/44

CODICE: CODE: ON/OFF	CCT (K)	CRI	W	Flusso luminoso reale (lm) Real luminous flux (lm)
15539-IO	3000	80	12	900 lm
15540-IO	4000	80	12	935 lm

Round $\varnothing 232 \times h 39$ mm

Plafone/Ceiling

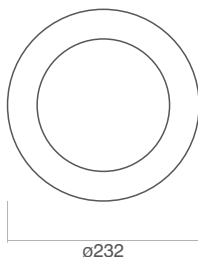

220 Vac

misure in mm / measurements in mm

Bianco
White

IP20/44

CODICE: CODE: ON/OFF	CCT (K)	CRI	W	Flusso luminoso reale (lm) Real luminous flux (lm)
15544-IO	3000	80	18	1430 lm
15545-IO	4000	80	18	1490 lm

Square 128x128xh39mm

Plafone/Ceiling

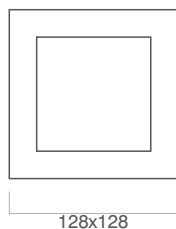

220 (Vac)

measure in mm / measurements in mm

Bianco
White

IP20/44

CODICE: CODE: ON/OFF	CCT (K)	CRI	W	Flusso luminoso reale (lm) Real luminous flux (lm)
15546-IO	3000	80	6	400 lm
15547-IO	4000	80	6	415 lm

Square 181x181xh39mm

Plafone/Ceiling

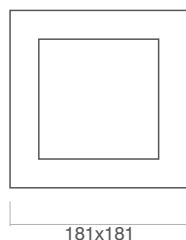

220 (Vac)

measure in mm / measurements in mm

Bianco
White

IP20/44

CODICE: CODE: ON/OFF	CCT (K)	CRI	W	Flusso luminoso reale (lm) Real luminous flux (lm)
15548-IO	3000	80	12	900 lm
15549-IO	4000	80	12	935 lm

Square 231x231xh39mm

Plafone/Ceiling

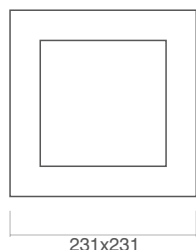

220 (Vac)

measure in mm / measurements in mm

Bianco
White

IP20/44

CODICE: CODE: ON/OFF	CCT (K)	CRI	W	Flusso luminoso reale (lm) Real luminous flux (lm)
15554-IO	3000	80	18	1430 lm
15555-IO	4000	80	18	1490 lm

ACCESSORI/ACCESSORIES

CASE A PLAFONE/CEILING CASE

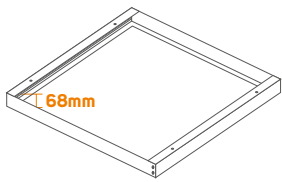

18026
Per pannello
595x595x25h mm
For panel
595x595x25h mm

18028
Per pannello
1195x295x25h mm
For panel
1195x295x25h mm

18044
Per pannello
1195x595x30h mm
For panel
1195x595x30h mm

**Back
Light**

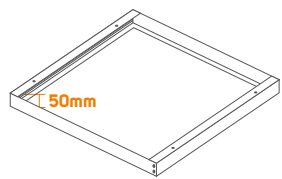

18031
Per pannello
595x595x9,5h mm
For panel
595x595x9,5h mm

18032
Per pannello
1195x295x9,5h mm
For panel
1195x295x9,5h mm

18033
Per pannello
595x295x9,5h mm
For panel
595x295x9,5h mm

**Edge
Light**

CORNICE INCASSO/RECESSED FRAME CASE

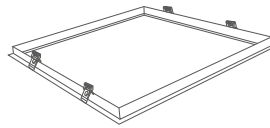

18027
Per pannello
595x595x25h mm
For panel
595x595x25h mm

18029
Per pannello
1195x295x25h mm
For panel
1195x295x25h mm

18005
Per pannello
1195x595x30h mm
For panel
1195x595x30h mm

**Back
Light**

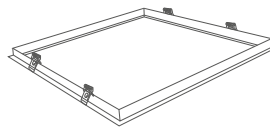

18027
Per pannello
595x595x9,5h mm
For panel
595x595x9,5h mm

18029
Per pannello
1195x295x9,5h mm
For panel
1195x295x9,5h mm

18006
Per pannello
595x295x9,5h mm
For panel
595x295x9,5h mm

**Edge
Light**

KIT SOSPENSIONE/SUSPENSION KIT

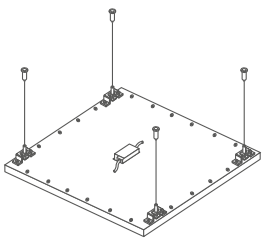

15159
Kit sospensione 4 cavi
L=1000mm
Suspension kit 4 cables
L=1000mm

**Edge
Light**

KIT ATTACCO BINARIO/TRACK ATTACHMENT KIT

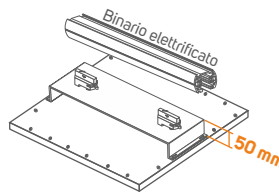

18125
Kit attacco binario
bianco per pannelli
595x595
White track attachment kit
for 595x595
panels L=1000mm

**Back
Light
Edge
Light**

18135
Kit attacco binario
bianco per pannelli
1195x295
White track attachment kit
for 1195x295
panels L=1000mm

**Back
Light
Edge
Light**





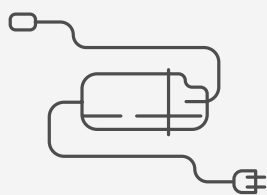

Alimentatori

Power supplies

I nostri alimentatori in tensione e in corrente offrono soluzioni affidabili e sicure per il vostro sistema di illuminazione.

Our voltage and current power supplies offer reliable and safe solutions for your lighting system.





Tensione costante/Constant voltage

Classe II - IP20

	CODE:	Watt	Output	Input	Frequency	Dimension WxLxH
	AL00256	15W	24Vdc	200/240Vac	50/60Hz	39,5x101x19,5mm
	07210	30W	24Vdc	220/240Vac	50/60Hz	44,6x123x19,2mm
	AL00254	60W	24Vdc	220/240Vac	50/60Hz	44,5x170x28mm
	AL00255	75W	24Vdc	220/240Vac	50/60Hz	45x170x29mm
	07260	100W	24Vdc	200/240Vac	50/60Hz	44,5x170x28mm
	AL00252	120W	24Vdc	220/240Vac	50/60Hz	45x316x33mm
	07145	150W	24Vdc	220/240Vac	50/60Hz	67x210x29mm
	AL00253	180W	24Vdc	220/240Vac	50/60Hz	45x316x33mm
	AL00251	320W	24Vdc	220/240Vac	50/60Hz	77,5x215x35mm

Tensione costante DALI2/PUSH/Constant voltage DALI2/PUSH

Classe II - IP20

	CODE:	Watt	Output	Input	Frequency	Dimension WxLxH
	09357	45W	24Vdc	220/240Vac	50/60Hz	45x187x30,5mm
	09358	80W	24Vdc	220/240Vac	50/60Hz	45x290x30,5mm
	09359	150W	24Vdc	220/240Vac	50/60Hz	45x290x30,5mm





Tensione costante per esterno/Constant voltage for outdoor

Classe II - IP67

	CODE:	Watt	Output	Input	Frequency	Dimension WxLxH
	AL00305	24W	24Vdc	220/240Vac	50/60Hz	40x110x29,5mm
	AL00306	35W	24Vdc	220/240Vac	50/60Hz	40x110x29,5mm
	AL00307	60W	24Vdc	220/240Vac	50/60Hz	41,5x155,5x30mm
	AL00308	100W	24Vdc	220/240Vac	50/60Hz	47,6x155,6x32,5mm
	AL00318	150W	24Vdc	220/240Vac	50/60Hz	63x191x37,5mm
	07321	200W	24Vdc	100/305Vac	47/63Hz	63x199x35,5mm
	AL00309	240W	24Vdc	200/277Vac	50/60Hz	62,5x220,6x41mm
	AL00310	320W	24Vdc	200/277Vac	50/60Hz	62,5x261x41,4mm

Tensione costante SLIM/Constant voltage SLIM

Classe II - IP20

	CODE:	Watt	Output	Input	Frequency	Dimension WxLxH
	07474	30W	24Vdc	200/240Vac	50/60Hz	30x251x16mm
	07604	60W	24Vdc	220/240Vac	50/60Hz	30x304,6x16,7mm
	07617	100W	24Vdc	200/240Vac	50/60Hz	30x321x18mm
	07619	150W	24Vdc	200/240Vac	50/60Hz	30x322x21,5mm

Tensione costante SLIM/Constant voltage SLIM

Classe II - IP66



CODE:	Watt	Output	Input	Frequency	Dimension WxLxH
07634	150W	24Vdc	200/240Vac	50/60Hz	30x356x23mm

DIMMERABILE 1-10V/DIMMABLE 1-10V

Classe II - IP67



CODE:	Watt	Output	Input	Frequency	Dimension WxLxH
07270	150W	24Vdc	190-265Vac	47/63Hz	68x228x39mm



07310	185W	24Vdc	90-305Vac	47/63Hz	68x228x39mm
-------	------	-------	-----------	---------	-------------



07280	240W	24Vdc	90-305Vac	47/63Hz	68x244x39mm
-------	------	-------	-----------	---------	-------------



07340	320W	24Vdc	90-305Vac	47/63Hz	90x252x44mm
-------	------	-------	-----------	---------	-------------

DIMMERABILE DALI/DIMMABLE DALI

Classe II - IP67



CODE:	Watt	Output	Input	Frequency	Dimension WxLxH
07515	150W	24Vdc	100/250Vac	47/63Hz	63x219x35,5mm



07521	240W	24Vdc	100/250Vac	47/63Hz	71x244x37,5mm
-------	------	-------	------------	---------	---------------

48Vdc

Classe II - IP65



CODE:	Watt	Output	Input	Frequency	Dimension WxLxH
07544	480W	48Vdc	115/230Vac	47/63Hz	125x262x43,8mm

Tensione costante taglio di fase/ Constant voltage phase cut

Classe II - IP20



CODE:	Watt	Output	Input	Frequency	Dimension WxLxH
07648	30W	24Vdc	220/240Vac	50/60Hz	45,8x158x18,3mm
07649	50W	24Vdc	220/240Vac	50/60Hz	58x177x22mm
07656	100W	24Vdc	220/240Vac	50/60Hz	58x177x22mm
07657	150W	24Vdc	220/240Vac	50/60Hz	67x195x31mm

Taglio di fase discendente (Trailing Edge): in cui il dimmer parzializza la parte finale della semionda, per cui la corrente elettrica viene spenta alla fine della forma d'onda d'ingresso AC subito prima del passaggio per lo zero crossing.

Descending phase cut (Trailing Edge): in which the dimmer chokes the final part of the half-wave, so that the electric current is switched off at the end of the AC input waveform just before the passage through the zero crossing.

EMERGENZA/EMERGENCY

Classe II - IP20 - Tempo di ricarica 24H/Charging time 24H



CODE:	Output	Input	Frequency	Autonomy	Dimension WxLxH
07550	90Vdc/2A	220/240Vac	50/60Hz	3 H	51,5x156x26mm (unit) 65x196x33mm (battery)

Corrente costante 350mA/Constant current 350mA

Classe II - IP42



CODE:	Watt	Output	Input	N°LED	Frequency	Dimension WxLxH
03170	8W	2-23Vdc	100/240Vac	1min. 7max.	50/60Hz	31x52x21mm
03040	12W	2-34Vdc	220-240Vac	2min. 10max.	50/60Hz	39x98x22mm
03241	16W	12-48Vdc	180-264Vac	5min. 16max.	47/63Hz	40x90x29mm
03259	25W	25-70Vdc	90-264Vac	9min. 22max.	47/63Hz	57x98,6x29,5mm

Corrente costante 500mA/Constant current 500mA

Classe II - IP20



CODE:	Watt	Output	Input	N°LED	Frequency	Dimension WxLxH
03120	6W	2-12Vdc	220/240Vac	2min. 3max.	50/60Hz	47x113x44mm
03130	20W	2-40Vdc	220-240Vac	1min. 12max.	50/60Hz	44x113x27mm

Corrente costante 350mA/Constant current 350mA

Classe II - IP65/IP67



CODE:	Watt	Output	Input	N°LED	Frequency	Dimension WxLxH
03020	8W	2-24Vdc	190/265Vac	1min. 6max.	50/60Hz	ø54x20mm
07440	17W	9-48Vdc	90-264Vac	4min. 16max.	47/63Hz	35x118x26mm

Corrente costante 500mA/Constant current 500mA

Classe II - IP65



CODE:	Watt	Output	Input	N°LED	Frequency	Dimension WxLxH
03022	8W	2-18Vdc	220/240Vac	1min. 4max.	50/60Hz	ø54x20mm

Multicorrente DALI/Multicurrent DALI

Classe II - IP20



CODE:	Watt	I Out DC	Input	Frequency	Dimension WxLxH
03152	0-20W	250-700mA	220/240Vac	50/60Hz	52x111x22mm
03151	0-32W	250-700mA	220/240Vac	50/60Hz	67x103x21mm

Multicorrente DALI/PUSH/Multicurrent DALI/PUSH

Classe II - IP20



CODE:	Watt	I Out DC	Input	Frequency	Dimension WxLxH
09254	0-42W	350-1050mA	180/295Vac	47/63Hz	81,5x123,5x23mm
09255	0-60W	500-1400mA	180/295Vac	47/63Hz	81,5x123,5x23mm

Multicorrente PUSH/1-10V/Multicurrent PUSH/1-10V

Classe II - IP20



CODE:	Watt	I Out DC	Input	Frequency	Dimension WxLxH
03155	0-20W	100-380mA	220/240Vac	50/60Hz	52x111x22mm
03150	0-32W	250-900mA	220/240Vac	50/60Hz	67x103x21mm

Multicorrente 1-10V/Multicurrent 1-10V

Classe II - IP20



CODE:	Watt	I Out DC	Input	Frequency	Dimension WxLxH
03230	0-42W	350-1050mA	180/295Vac	47/63Hz	81,5x123,5x23mm
09232	0-60W	500-1400mA	180/295Vac	47/63Hz	81,5x123,5x23mm





Controller

Controllers

I nostri controller per LED offrono un controllo avanzato, flessibilità e facilità d'uso per creare scenari di illuminazione personalizzati e creativi.

Our LED controllers offer advanced control, flexibility and ease of use to create customized and creative lighting scenarios.

La luce prende forma: connessa, intuitiva, essenziale

Light takes shape: connected, intuitive, essential.



ZETAQLAB azienda di Starlight Group specializzata nella gestione digitale della luce, soprattutto con tecnologie wireless, è il partner a cui ci siamo affidati per lo sviluppo dei sistemi di controllo dell'illuminazione. Crediamo che le nuove tecnologie ci aiuteranno ad ottimizzare risorse e costi, riducendo gli sprechi al minimo, e la gestione degli spazi in modi smart semplificherà ogni progetto.

ZETAQLAB, a company of Starlight Group expert in digital light management, primarily with wireless technologies is our reliable partner for the development of lighting control systems. The new technologies will help us to optimize resources and costs, minimizing waste and the smart management of the spaces will simplify every project.

Cerca il logo ZETAQLAB nelle pagine tecniche per scoprire i prodotti coinvolti.

Per approfondimenti, visita il sito:
www.zetaqlab.com

Look for the ZETAQLAB logo in the technical pages and find out the related products.

For more information, visit:
www.zetaqlab.com



Lighting

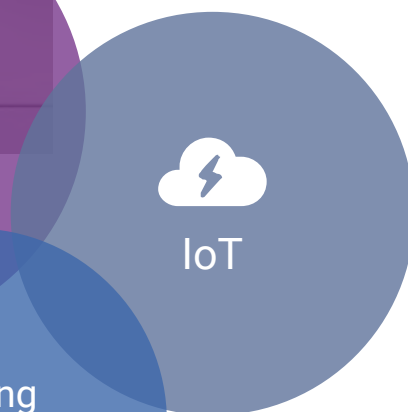

IoT

Building
Automation

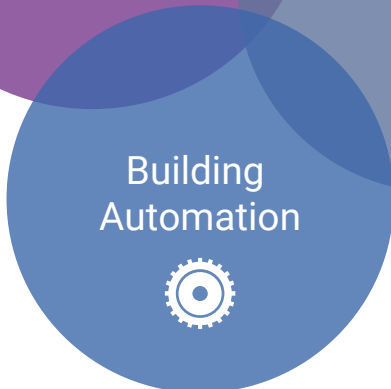

Tecnologie per la gestione cablata degli apparecchi

Technologies for wired luminaires management



I protocolli digitali DALI e DMX permettono il controllo cablato degli apparecchi d'illuminazione normali e di emergenza.

Digital DALI e DMX protocols allow wired management of standard and emergency luminaires.

Il protocollo **DALI «Digital Addressable Lighting Interface»**, normato dalla DiiA – Digital Illumination Interface Alliance (www.dali-alliance.org), costituisce lo stato dell'arte per la gestione digitale della luce, permettendo un dialogo bidirezionale tra sistema di controllo ed apparecchi e lo scambio di comandi e la ricezione di informazioni sulla diagnostica.

Mentre la prima versione del protocollo si riferiva agli attuatori (apparecchi), la nuova release **DALI-2** definisce gli standard funzionali relativi ai dispositivi di controllo, come pulsanti e sensori, ed introduce l'architettura Multi-Master che consente la presenza sullo stesso bus di più dispositivi in grado di inviare simultaneamente messaggi.

The **DALI «Digital Addressable Lighting Interface»** protocol, regulated by the DiiA - Digital Illumination Interface Alliance (www.dali-alliance.org), is the state of the art for digital light management. It allows a two-way communication between the control system and luminaires and the exchange of commands and receipt of diagnostic information.

While the first version of the protocol referred to actuators (luminaires), the new **DALI-2** release defines the functional standards of control devices, such as buttons and sensors, and introduces the Multi-Master architecture that enables multiple devices, capable of sending messages simultaneously, to be present on the same bus.

Il protocollo **DMX «Digital Multiplex»** costituisce lo stato dell'arte per la gestione digitale della luce colorata, dove spesso è richiesta un'elevata velocità di variazione di intensità e colori, ad esempio per applicazioni scenografiche sincronizzate con audio e video. L'estensione del protocollo **RDM (Remote Device Management)** permette la gestione bidirezionale degli apparecchi, semplificando le attività di configurazione e manutenzione dell'impianto.

The **DMX «Digital Multiplex»** protocol is the state of the art for the digital management of colored light, where a high speed of variation of intensity and colors is often required, for example for scenographic applications synchronized with audio and video. The **RDM (Remote Device Management)** extension of the protocol allows bidirectional management of the luminaires, simplifying system configuration and maintenance.

La tecnologia DALI permette di gestire dispositivi di natura diversa, definendo le estensioni funzionali o applicative tramite differenti Device Type (DT). I principali profili sono dedicati ai driver LED a singolo canale (DT6), a quelli con due o più canali di colore (DT8) come Tunable White o RGBW ed agli apparecchi di emergenza (DT1).

DALI technology allows to manage various types of devices, defining functional or application extensions through different Device Type (DT). The main profiles are dedicated to single channel LED drivers (DT6), to those with two or more color channels (DT8) such as Tunable White or RGBW and to emergency luminaires (DT1).



DALI-2

Su un bus DALI-2 possono essere presenti fino a 64 apparecchi e fino a 64 dispositivi di comando (sensori, interfacce pulsanti, ecc.). Si utilizza un cavo a due poli senza polarità, dello stesso tipo previsto per le linee di alimentazione. Il bus DALI può essere stesso accanto alla linea di potenza.

Up to 64 luminaires and up to 64 control devices (sensors, button interfaces, etc.) can be present on a DALI-2 bus. A polarity-free cable with two poles is used, of the same type as the power supply lines. The DALI bus can be laid next to the power line.

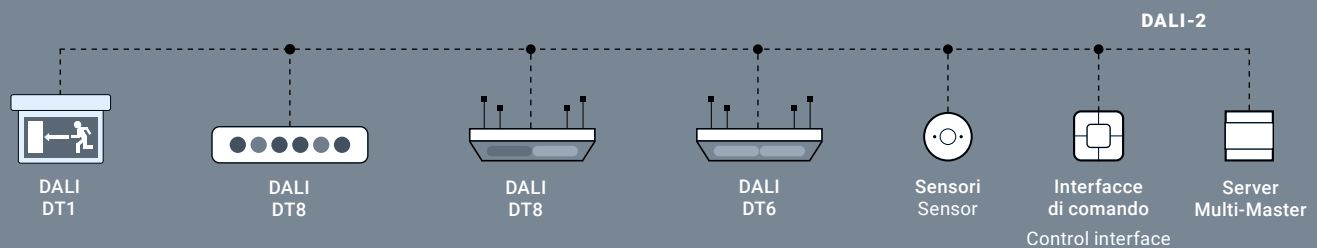

DMX-RDM

Un universo DMX-RDM può gestire fino a 512 canali di colore. Gli apparecchi possono essere collegati su rami cablati in gruppi di massimo 30 unità, utilizzando un cavo RS485 (con polarità e schermatura). Questi bus non possono essere stessi accanto alle linee di potenza.

A DMX-RDM universe can manage up to 512 color channels. The devices can be connected on wired branches in groups of up to 30 units, using a RS485 cable (with polarity and shield). These buses cannot be laid next to the power lines.

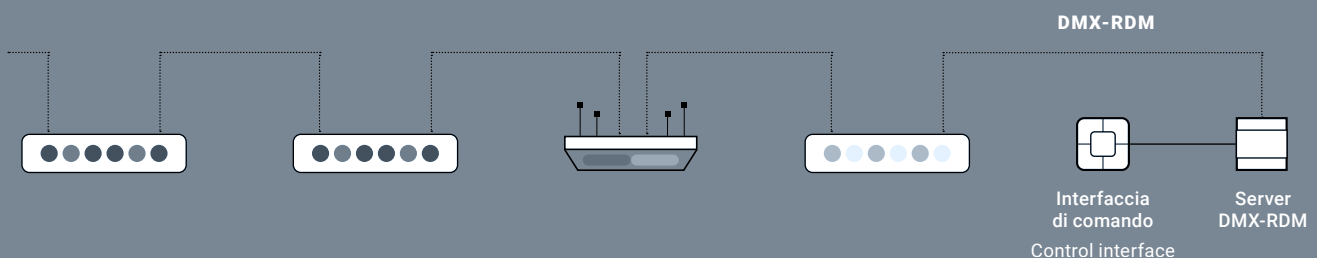

Tecnologie wireless per il controllo dell'illuminazione

Wireless technologies for lighting control

Grazie ai protocolli standard Bluetooth LE e Zigbee 3.0 è possibile gestire gli apparecchi d'illuminazione tramite smartphone.

Thanks to Bluetooth LE e Zigbee 3.0 standard protocols, luminaires can be managed by Smartphone

I sistemi ZETAQLAB sono equipaggiati con interfaccia **Wireless Mesh Network 2.4 GHz a doppia tecnologia Bluetooth LE/Zigbee 3.0**, che permette contemporaneamente la connessione di dispositivi mobile tramite Bluetooth LE e l'interconnessione dei nodi del sistema grazie al protocollo standard Zigbee 3.0, abilitandoli all'integrazione con tutto l'ecosistema di prodotti compatibili, come gli Home Assistant e gli altri dispositivi per la domotica e la Building Automation.

Ogni nodo della rete Zigbee 3.0 riceve, rigenera ed invia nuovamente il segnale ai nodi successivi, creando quindi una rete wireless Mesh Network. Poichè la distanza massima tra due nodi adiacenti non può superare i 20/30 m, in alcune applicazioni è necessario utilizzare soluzioni wireless più performanti: per tale motivo ZETAQLAB ha sviluppato un **protocollo proprietario Mesh Network Long Range basato sulla frequenza 868 MHz**, tecnologia più adatta a coprire distanze elevate (fino a 500 m), utile ad esempio per il controllo in outdoor delle torri faro.

ZETAQLAB systems are equipped with a **2.4 GHz Wireless Mesh Network interface with dual Bluetooth LE/Zigbee 3.0 technology**, which allows at the same time the connection of mobile devices via Bluetooth LE and the interconnection of the system nodes thanks to the standard Zigbee 3.0 protocol, enabling them to integrate with the entire ecosystem of compatible products, such as Home Assistants and other devices for Home and Building Automation.

Each node of the Zigbee 3.0 network receives, regenerates and sends again the signal to the subsequent nodes, thus creating a wireless Mesh Network. As the maximum distance between two adjacent nodes cannot exceed 20/30 meters, in some applications it is necessary to use more performing wireless solutions: for this reason ZETAQLAB has developed a **proprietary Long Range Mesh Network protocol based on the 868 MHz frequency**, a technology more suitable for long distances (up to 500 m), useful for example for outdoor control of light towers.

Bluetooth LE

Zigbee 3.0

868 MHz

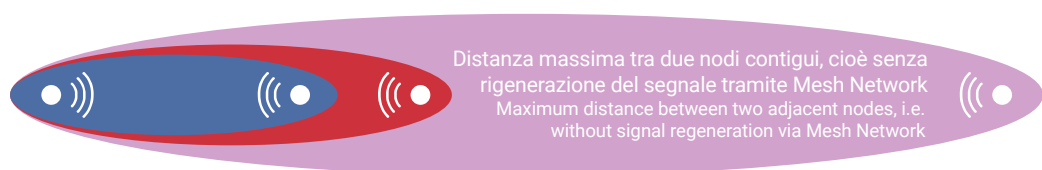

Bluetooth

zigbee

ZETAQLAB
868 MHz

SISTEMI STAND ALONE E CENTRALIZZATI

Stand alone and centralized systems

I sistemi ZETAQLAB possono essere configurati tramite App e lavorare in modo indipendente (Stand Alone) senza la necessità di un server e/o software centrale. Ciò permette di limitare il tempo ed il costo di implementazione dell'impianto, evitando la necessità di interventi di tecnici specializzati. I prodotti hardware basati su tecnologia wireless 2.4 GHz possono connettersi direttamente allo smartphone grazie a Bluetooth LE, mentre quelli a 868 MHz richiedono un componente intermedio (gateway portatile), che traduce i comandi ricevuti dalla smartphone tramite Bluetooth LE in comandi sulla rete wireless 868 MHz.

Gli impianti centralizzati e gestiti tramite software saranno completati da opportuni moduli gateway, che permettono di suddividere il sistema in aree interconnesse tra loro tramite rete Ethernet. Per maggiori informazioni si veda l'architettura del sistema a pagina seguente.

ZETAQLAB systems can be configured via App and work independently (Stand Alone) without the need for a central server and/or software. This allows to limit the time and cost of implementing the system, avoiding the need for the intervention of specialized technicians. Hardware products based on 2.4 GHz wireless technology can connect directly to the smartphone thanks to Bluetooth LE, while those at 868 MHz require an intermediate component (portable gateway), which translates the commands received from the smartphone via Bluetooth LE into commands over the 868 MHz wireless network.

The centralized systems managed by software will be completed by appropriate gateway modules, which enable the installation to be divided into interconnected areas by means of an Ethernet network. For more information, see the system architecture on the next page.

Sistemi 2.4 GHz / 2.4 GHz systems

La connessione con i nodi del sistema avviene direttamente dallo smartphone grazie alla tecnologia wireless Bluetooth LE.

The connection with the system nodes takes place directly from the smartphone thanks to the Bluetooth LE wireless technology.

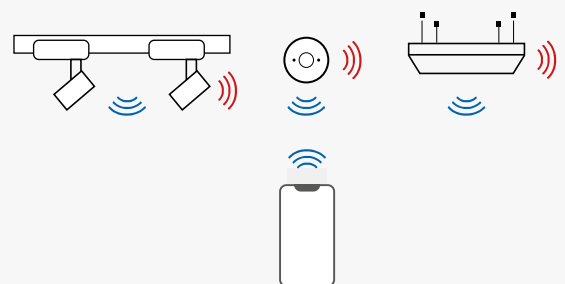

Sistemi 868 MHz / 868 MHz systems

La connessione con i nodi 868 MHz del sistema avviene tramite un gateway, che si collega allo smartphone grazie a Bluetooth LE

The connection with the 868 MHz nodes of the system takes place through the gateway, which connects to the smartphone thanks to Bluetooth LE.

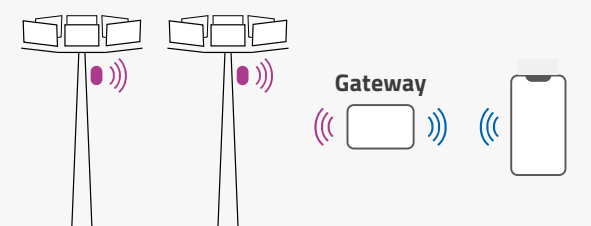

Soluzioni per il controllo dell'illuminazione

Lighting control solution

Sistemi hardware e software per la gestione cablata e wireless degli apparecchi d'illuminazione normali e di emergenza.

Hardware and software systems for wired and wireless management of standard and emergency luminaires

Sensori / Sensors



Rilevano movimento ed intensità luminosa ambientale al fine di automatizzare la regolazione degli apparecchi

They detect motion and daylight intensity in order to automate the adjustment of the luminaires

Interfacce di comando / Control interfaces



Permettono all'utente di impostare manualmente scenografie, intensità e colore degli apparecchi

They enable the user to manually set the scenes, intensity and color of the luminaires

Dimmer - Controller wireless

Wireless dimmers - controllers



Abbinati ad apparecchi, ne gestiscono l'intensità luminosa in base a comandi ricevuti via wireless

Combined with luminaires, they manage light level based on commands received via wireless

Dimmer - Controller cablati

Wired dimmers - controllers



Gestiscono l'intensità luminosa di apparecchi in base a sensori, comandi manuali e profili orari

They manage light level of luminaires based on sensors, manual controls and time profiles



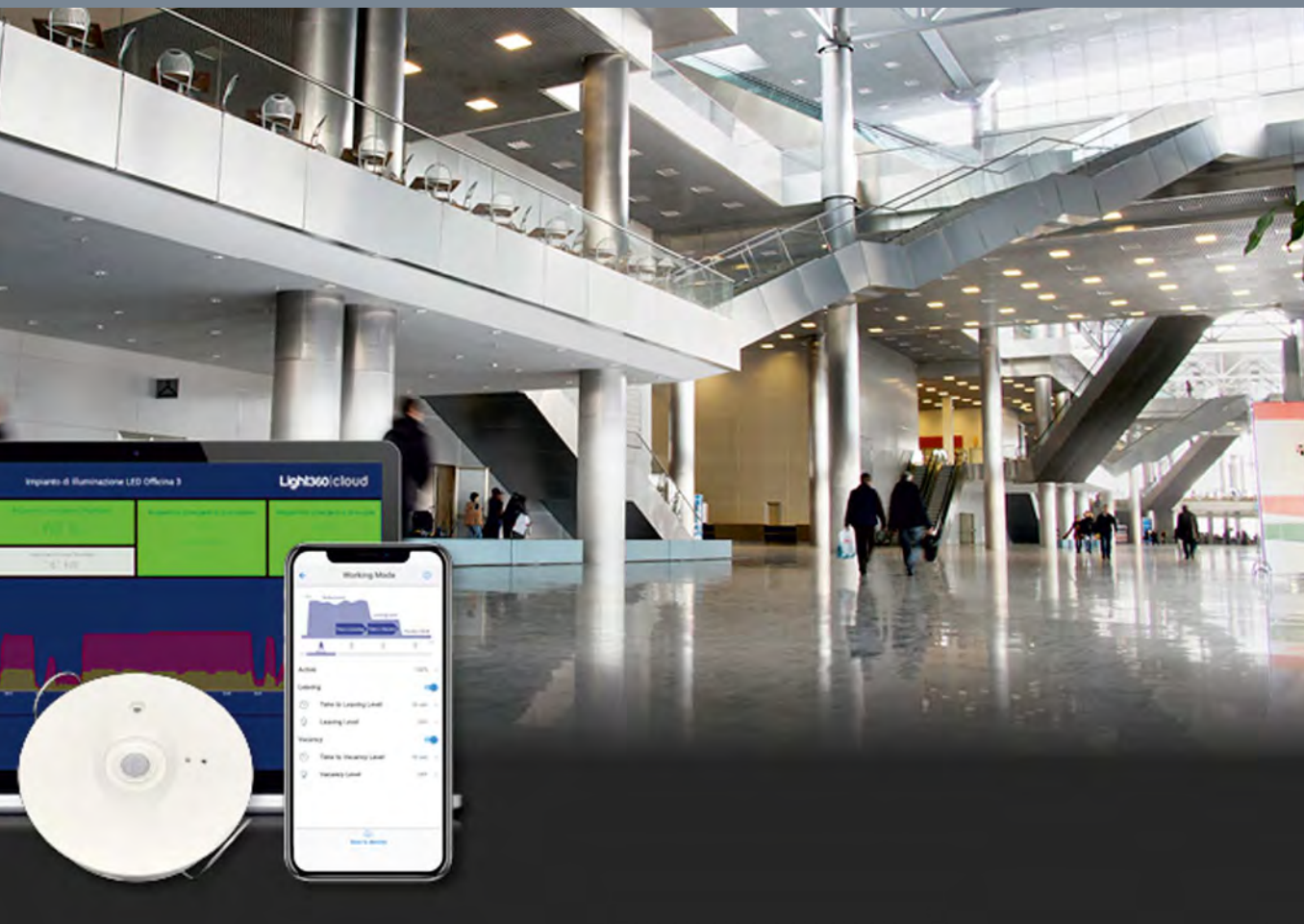

Web-Apps



Permettono all'utente di configurare e supervisionare il sistema tramite rete Intranet o Cloud (internet)

They allow the user to configure and supervise the system via the Intranet or Cloud (internet)

Apps



Permettono all'utente di configurare e gestire il sistema localmente tramite Smartphone

They allow the user to configure and manage the system locally via Smartphone

Servers



Ospitano le applicazioni software di configurazione, supervisione, integrazione e diagnostica centralizzata

They host software applications for configuration, supervision, integration and centralized diagnostics

Controllo di StripLED

LED strips control

Scenografie luminose in applicazioni residenziali e professionali.

Light scenes in residential and professional applications.

I sistemi ZETAQLAB permettono di gestire in modo automatico e manuale scenografie luminose, anche di strisce LED Tunable White, RGB ed RGBW. Grazie alle soluzioni wireless puoi eseguire il relamping di impianti esistenti senza modificare l'impianto elettrico. Tramite l'App Light360|Setup il sistema può essere configurato da personale non specializzato, riducendo tempi e costi di realizzazione e semplificando la manutenzione dell'impianto.

ZETAQLAB systems enable you to automatically and manually manage light scenes, including Tunable White, RGB and RGBW LED strips. Thanks to wireless solutions, you can relamp existing systems without modifying the electrical one. Through the Light360|Setup App, the system can be configured by non specialized personnel, reducing commissioning times and costs and simplifying system maintenance.

SOLUZIONE CABLATA / WIRED SOLUTION

Le strisce LED, i sensori ed i moduli di comando sono tutti cablati tra loro tramite bus DALI o DALI-2. Questa soluzione è ideale per impianti nuovi di qualsiasi dimensione, dove è possibile stendere un cavo dedicato al controllo degli apparecchi e dove viene richiesta la gestione sinergica di più zone. Le soluzioni cablate sono compatibili con l'ecosistema ZETAQLAB basato su standard DALI-2.

LED strips, sensors and control modules are all wired together via DALI or DALI-2 bus. This solution is ideal for new systems of any size, where it is possible to lay a cable dedicated to the control of the luminaires and where the synergical management of several zones is required. The wired solutions are compatible with the ZETAQLAB ecosystem based on the DALI-2 standard.

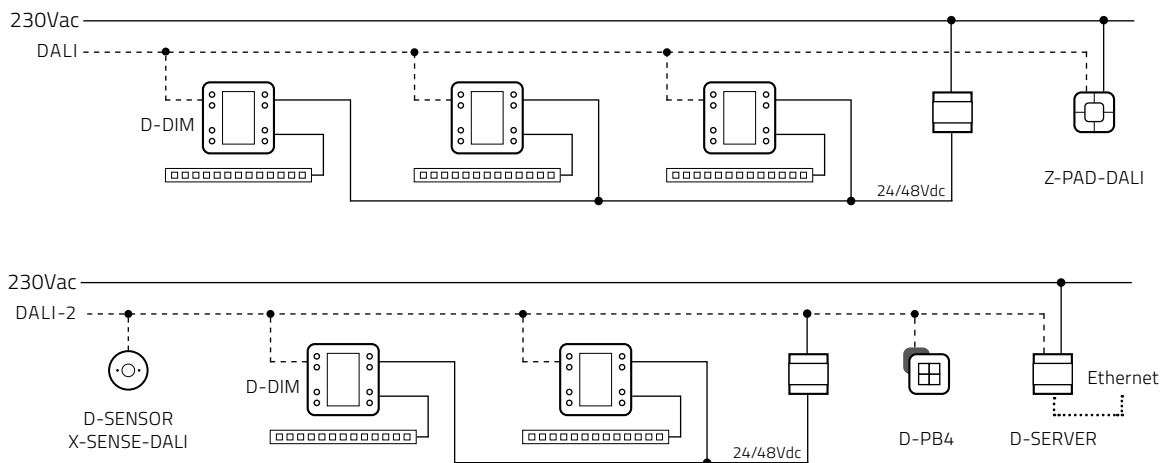

I sistemi di controllo sono ideali per la gestione della luce in molteplici e differenti contesti:

Control systems are ideal for managing light in various and different environments:

- Uffici / Offices
- Scuole / Schools
- Ospedali / Hospitals
- Industria / Industry
- Logistica / Logistics
- Campi sportivi / Sports fields
- Aeroporti / Airports
- Parcheggi / Parking lots
- Parchi / Parks
- Piste ciclabili / Cycle lanes
- Applicazioni architettoniche indoor e outdoor
Indoor and outdoor architectural applications



SOLUZIONE WIRELESS / WIRELESS SOLUTION

Le strisce LED, i sensori ed i moduli di comando sono tutti connessi tramite tecnologia wireless. Questa soluzione è ideale per impianti esistenti di qualsiasi dimensione, dove non è possibile modificare l'impianto elettrico. Le soluzioni wireless sono compatibili anche con assistenti vocali Zigbee 3.0, come ad esempio Alexa.

LED strips, sensors and control modules are all connected via wireless technology. This solution is ideal for existing systems of any size, where the electrical system can not be modified. The wireless solutions are also compatible with Zigbee 3.0 voice assistants, such as Alexa.

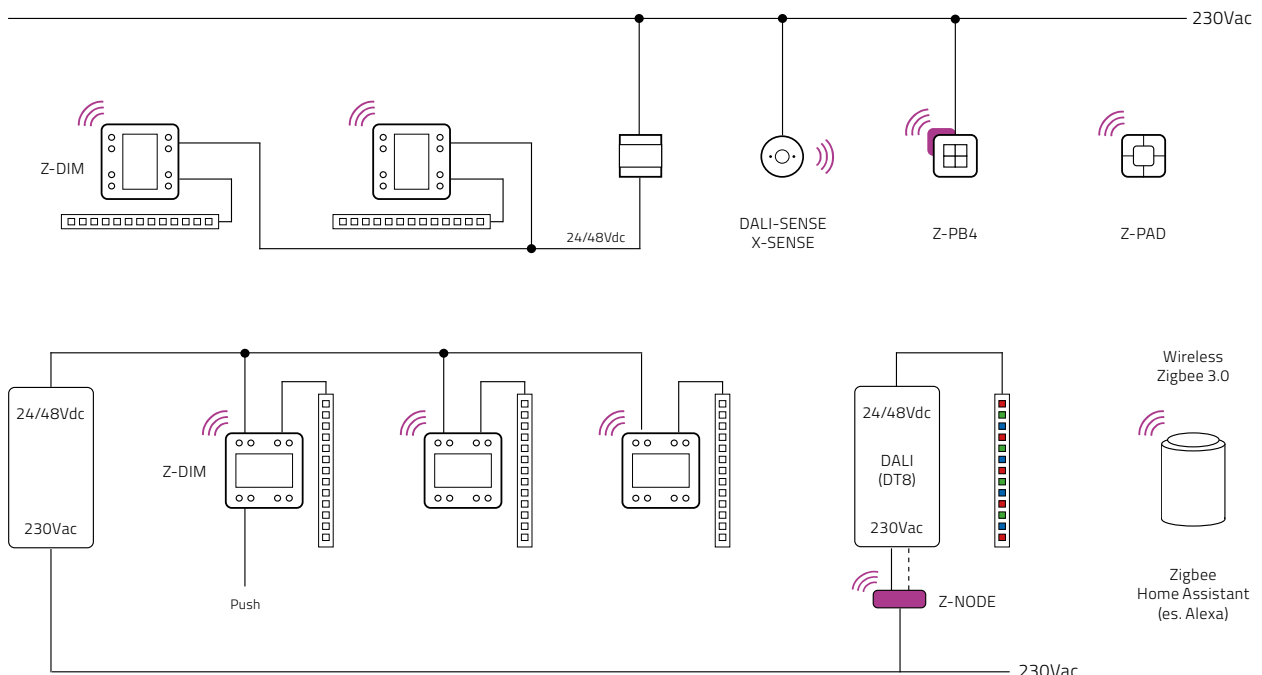

Controller

Index

	Pag.
DIMMER MONO CHANNEL DALI2/PUSH/0-10V/1-10V 24VDC - D-DIM 24	446
DIMMER MONO CHANNEL DALI2/PUSH/0-10V/1-10V 48VDC - D-DIM 48	447
MONOCROMATIC: DALI/PUSH/0-10V/1-10V - 09259	448
DIMMER MONOCROMATICO CON RADIO CONTROL - 09280	449
MULTIDIMMER MONO/TUNABLE WHITE/RGB/RGB+W - 09325	450
CONTROLLER TUNABLE WHITE CON REMOTE CONTROL - 09156	451
CONTROLLER PER LED RGB CON REMOTE CONTROL - 09000	452
CONTROLLER PER LED RGB+W + REMOTE CONTROL - 09145	453
CONTROLLER PER LED RGB + CCT + REMOTE CONTROL - 09277	454
COMPATIBLE 4 IN 1 PUSH DALI DT8 LED CONTROLLER - 09353	455
MINI DIMMER BLUETOOTH PUSH MONO - 09286	456
CONTROLLER BLUETOOTH/PUSH - 09287	457
DIMMER CASAMBI/PUSH - 09295	458
CONTROLLER TOUCH + DMX512 CAPACITIVE TUNABLE WHITE - 09309	459
CONTROLLER TOUCH CAPACITIVE RGB / RGB + W - 09042	460
CONTROLLER TOUCH + DMX512 4CH - 09330	461
COMANDO VOCALE ALEXA/GOOGLE HOME WI-FI - 09346	462
CONTROLLER MULTIDIMMER PUSH/0-10V/0-5V/DMX512 - 09171	463
CONTROL SYSTEM RGB PUSH - 09180	464
CONTROLLER RGB CURRENT REMOTE CONTROL - 09010	465
CONTROLLER GATEWAY - ZIGBEE PER MONOCOLORE E RGB - 09002	466
RGB+W - DIMMER RGB+W - 09004	467
MONOCOLORE - DIMMER MONOCROMATIC RADIO/PUSH - 09003	468
CONTROLLER STRIP LED PIXEL RGB+W - 09347	469
ACCESSORIES FOR PROFILE: PIR 03102 /DIMMER TOUCH 14071	470
DIMMER MONO CHANNEL PUSH/BLUETOOTH/ZIGBEE 3.0 24Vdc - Z-DIM 24	472
DIMMER MONO CHANNEL PUSH/BLUETOOTH/ZIGBEE 3.0 48Vdc - Z-DIM 48	473
CONTROLLER WIRELESS 2.4 GHz - Z-NB18	474
CONTROLLER WIRELESS 868 MHz - RFxLT	475
UNIVERSAL LIGHTING CONTROLLER WIRELESS 868 MHz/2.4GHz - ZQxULC-LT	476
2.4 GHz BLE/ZIGBEE TO DALI WIRELESS - Z-NODE	477
2.4 GHz BLE/ZIGBEE DIGITAL INPUT INTERFACE - Z-PB4 v1	478
2.4 GHz ZIGBEE/BLUETOOTH ETHERNET GATEWAY - Z-GWETH v1/X-CONNECT	479
DALI2 MULTI MASTER PUSH BUTTON COUPLER - D-PB4	482
DALI2 MULTI MASTER 2 CHANNEL RELAY MODULE - D-RL2	483

Touch Panel

TOUCH PANEL WITH ETHERNET WIFI/BLUETOOTH - **ZQ-TOUCH-10PDVX**

Pag.
484

Server

MULTIPURPOSE LIGHTING SERVER - **ZQxSERVER-LTE**

Pag.
480

DALI-2 MULTI-MASTER SERVER - **D-SERVER**

481

Sensori

Sensors

2.4 GHZ WIRELESS INTEGRATED - **Z-SENSOR**

Pag.

488

WIRELESS DALI MULTISENSOR - **DALI-SENSE v3**

489



DIMMER MONO CHANNEL DALI2/PUSH/0-10V/1-10V 24Vdc D-DIM24

ZQ



Scheda tecnica
Datasheet



I dimmer ZETAQLAB permettono la regolazione dell'intensità luminosa di strisce LED interponendosi tra esse ed il driver a tensione costante a 24 Vdc (non dimmerabile). La versione DALI-2 permette di integrare il dimmer con sistemi di automazione sia di ZETAQLAB che di terze parti.

ZETAQLAB dimmers enable the adjustment of light intensity of LED strips positioned between them and the constant voltage driver at 24 Vdc (not dimmable). The DALI-2 version allows the dimmer to be integrated with both ZETAQLAB and third-party automation systems.

FOR EU MARKETS ONLY

CODICE: CODE:	TENSIONE IN INGRESSO: INPUT VOLTAGE:	CORRENTE IN USCITA: OUTPUT CURRENT:	POTENZA: POWER:	CONTROLLO IN INGRESSO: CONTROL INPUT:	DIMENSIONI LxPxH: DIMENSION LxWxH:
09369 (D-DIM24)	24 Vdc	max 11A	264W	PUSH 0-10V 1-10V DALI-2	41 x 47 x 20 mm

DIMMER MONO CHANNEL DALI2/PUSH/0-10V/1-10V 48Vdc

D-DIM48



Scheda tecnica
Datasheet



I dimmer ZETAQLAB permettono la regolazione dell'intensità luminosa di strisce LED interponendosi tra esse ed il driver a tensione costante a 48 Vdc (non dimmerabile). La versione DALI-2 permette di integrare il dimmer con sistemi di automazione sia di ZETAQLAB che di terze parti.

ZETAQLAB dimmers enable the adjustment of light intensity of LED strips positioned between them and the constant voltage driver at 48 Vdc (not dimmable). The DALI-2 version allows the dimmer to be integrated with both ZETAQLAB and third-party automation systems.

FOR EU MARKETS ONLY

CODICE: CODE:	TENSIONE IN INGRESSO: INPUT VOLTAGE:	CORRENTE IN USCITA: OUTPUT CURRENT:	POTENZA: POWER:	CONTROLLO IN INGRESSO: CONTROL INPUT:	DIMENSIONI LxPxH: DIMENSION LxWxH:
09370 (D-DIM48)	48 Vdc	max 7A	336W	PUSH 0-10V 1-10V DALI-2	41 x 47 x 20 mm

DIMMER MONOCROMATIC: DALI/PUSH/0-10V/1-10V



Scheda tecnica
Datasheet

**Descrizione:**

Regolatore di luminosità per alimentatori in tensione a 12-24-48 VDC.

Funzione:

Tre modalità di funzionamento (in alternativa tra loro). Impostabili tramite jumper: Push dimming, DALI dimming e 1-10V Dimming

Caratteristiche:

Memorizzazione dell'ultimo dato di dimming. In presenza rete ad ogni ON il driver parte dall'ultimo dato impostato. Nell'interfaccia DALI la massima corrente assorbita 2mA in ricezione, e almeno 250mA in trasmissione

Description:

Brightness regulator for 12-24-48 VDC voltage power supplies.

Function:

Three modes of operation (alternatively between them). Settable via jumper: Push dimming, DALI dimming and 1-10V dimming

Features:

Storage of the last dimming data. In network presence at each ON the driver starts from the last data set. In the dali interface the maximum current absorbed 2ma in reception, and at least 250ma in transmission

CODICE: CODE:	TENSIONE IN INGRESSO: INPUT VOLTAGE:	CORRENTE IN USCITA: OUTPUT CURRENT:	POTENZA: POWER:	DIMENSIONI LxPxH: DIMENSION LxWxH:
09259	12 Vdc 24 Vdc 48 Vdc	5 A 5 A 5 A	60W 120W 240W	132 x 22 x 20 mm

DIMMER MONOCROMATICO CON RADIO CONTROL



Scheda tecnica
Datasheet



Descrizione:

Regolatore di luminosità per alimentatori in tensione a 12-24 VDC che offre una soluzione semplice ed efficace per la regolazione dell'intensità luminosa, tramite telecomando in radio frequenza, di moduli e strisce a led monocromatiche in bassa tensione.

Funzione:

- Telecomando in radio frequenza singola zona (ordinabile a parte)
- Telecomando in radio frequenza fino a 5 zone (ordinabile a parte)
- Pulsanti normalmente aperti (non compresi)

Description:



Dimmer for power supply 12-24VDC that offers a simple and effective solution for regulating the brightness with a radio frequency remote control of low voltage monochromatic strips and modules.

Function:

- Remote control single zone (ordered separately)
- Remote control up to 5 zones (ordered separately)
- Normally Open pushbuttons (not included)

CODICE: CODE:	TENSIONE IN INGRESSO: INPUT VOLTAGE:	CORRENTE IN USCITA: OUTPUT CURRENT:	POTENZA: POWER:	DIMENSIONI LxPxH: DIMENSION LxWxH:
09280	12 Vdc 24 Vdc	8 A 8 A	96 W 192 W	37 x 100 x 25 mm

OPZIONALE OPTIONAL

CODICE: CODE:	ALIMENTAZIONE: POWER SUPPLY:	FREQUENZA: FREQUENCY:	DIMENSIONI LxPxH: DIMENSION LxWxH:
REMOTE CONTROL ONE CHANNEL 09282 	6V (2xCR2025 BATTERY)	868/869.5/916.5/434 MHz	46 x 105 x 9,5 mm
REMOTE CONTROL 5 ZONE 09283 	3V (2xCR2025 BATTERY)	868/869.5/916.5/434 MHz	46 x 105 x 9,5 mm

CONTROLLER MULTIDIMMER: PUSH/0-10V/0-5V/DMX512 MONOCROMATICO/TUNABLE WHITE/RGB/RGB+W



Scheda tecnica
Datasheet



Descrizione:

Regolatore di luminosità per alimentatori in tensione a 12-24-48 VDC che offre una soluzione efficace per la regolazione dell'intensità luminosa di moduli e strisce a led RGB, RGB+W, Bianco dinamico e monocromatico in bassa tensione.

Funzione:

- Pulsanti normalmente aperti (non compresi)
- Ingressi analogici 0..10V e 0..5V
- Potenziometro (non compreso)
- DMX512 (master DMX non compreso)

Caratteristiche:

La modalità di funzionamento è impostabile tramite i selettori. Possibilità di collegare incascata più dispositivi.

Description:

Brightness regulator for 12-24-48 VDC voltage power supplies that offers an effective solution for adjusting the light intensity of RGB, RGB+W, dynamic white and monochrome modules and strips in low voltage.

Function:





- Buttons normally open
- Analog inputs 0.. 10V and 0.. 5V
- Potentiometer (not included)
- DMX512 (DMX master not included)

Features:

The operation mode can be set via selectors. Possibility to connect multiple devices.

CODICE: CODE:	TENSIONE IN INGRESSO: INPUT VOLTAGE:	CORRENTE IN USCITA: OUTPUT CURRENT:	POTENZA: POWER:	DIMENSIONI LxPxH: DIMENSION LxWxH:
09325	12 Vdc	4 x 5 A	4 x 60 W	92 x 72 x 62 mm
	24 Vdc	4 x 5 A	4 x 120 W	
	48 Vdc	4 x 5 A	4 x 240 W	

OPZIONALE OPTIONAL

CODICE: CODE:	TENSIONE IN INGRESSO: INPUT VOLTAGE:	CORRENTE/POTENZA IN USCITA: OUTPUT CURRENT/POWER:	SEGNALE IN USCITA: OUTPUT SIGNAL:	DIMENSIONI LxPxH: DIMENSION LxWxH:
RADIO FREQUENCY DMX PER RGB+W				
09085 	12 Vdc	-	DMX 512	45 x 107 x 24 mm
	24 Vdc	-	DMX 512	39 x 73 x 16 mm
DMX REPEATER/SEPARATOR				
09324 	12 Vdc	-	DMX 512	88 x 54 x 26 mm
	24 Vdc	-	DMX 512	
DMX TOUCH PANEL 503 FOR RGB+W				
09042 	12 Vdc	4 x 5 A / 4 x 60 W	DMX 512	120 x 80 x 11 mm
	24 Vdc	4 x 5 A / 4x120 W	DMX 512	
TOUCH DMX 4CH				
09330 	12 Vdc	-	DMX512	120 x 80 x 29,2 mm
	24 Vdc	-	DMX512	
CONTROLLER TOUCH FOR TUNABLE WHITE				
09309 	12 Vdc	3 x 5 A / 3 x 60 W	POTENZA: POWER: 3 x 60 W	120 x 80 x 11 mm
	24 Vdc	3 x 5 A / 3 x 120 W		

CONTROLLER TUNABLE WHITE CON REMOTE CONTROL



Scheda tecnica
Datasheet



Descrizione:

Sistema di controllo bianco dinamico con telecomando in radio frequenza.
Possibilità di controllare strip o moduli LED bianco dinamico in tensione costante in configurazione anodo comune.
20 Livelli di luminosità e 11 temperature colore richiamabili in modo semplice e pratico dal telecomando.

Funzione:

Telecomando a 2.4Ghz con trasmissione fino a 20-30 metri, funzionante tramite 2 batterie AAA (non incluse).

Caratteristiche:

Possibilità di aggiungere fino a 5 dispositivi. Ripetitori di segnale per aumentare il carico comandabile tramite il singolo telecomando.

Description:

Dynamic white control system with radio frequency remote control.
Possibility to control strips or dynamic white LED modules in constant voltage in common anode configuration.
20 brightness levels and 11 color temperatures can be easily and conveniently recalled from the remote control.

Function:

2.4ghz remote control with transmission up to 20-30 meters, working via 2 AAA batteries (not included).

Features:

Possibility to add up to 5 devices. Signal repeaters to increase the load controlled by the single remote control.

CODICE: CODE:	TENSIONE IN INGRESSO: INPUT VOLTAGE:	CORRENTE IN USCITA: OUTPUT CURRENT:	POTENZA: POWER:	DIMENSIONI LxPxH: DIMENSION LxWxH:
09156	12 Vdc 24 Vdc	2 x 6 A 2 x 6 A	2 x 72 W 2 x 144 W	83 x 80 x 33 mm (controller) 55,5 x 113,5 x 22,5 mm (remote control)

OPZIONALE OPTIONAL

CODICE: CODE:	TENSIONE IN INGRESSO: INPUT VOLTAGE:	CORRENTE IN USCITA: OUTPUT CURRENT:	POTENZA: POWER:	DIMENSIONI LxPxH: DIMENSION LxWxH:
09001	12 Vdc 24 Vdc	4 x 3 A 4 x 3 A	4 x 36 W 4 x 72 W	46 x 105 x 28 mm



CONTROLLER PER LED RGB + REMOTE CONTROL

MAX 432W



Scheda tecnica
Datasheet



Descrizione:

Sistema di controllo RGB con telecomando in radio frequenza. Possibilità di controllare strip o moduli LED RGB in tensione costante in configurazione anodo comune.

20 Programmi pre impostati richiamabili in modo semplice e pratico dal telecomando.

Funzione:

Telecomando a 2.4Ghz con trasmissione fino a 20-30 metri funzionante tramite 2 batterie AAA (non incluse)

Caratteristiche:

Possibilità di aggiungere fino a 5 dispositivi ripetitori di segnale per aumentare il carico comandabile tramite il singolo telecomando.

Description:

RGB Control system with radio frequency remote control. Controlling RGB constant voltage strip or module in common anode configuration. 20 Pre setted programs easily recallable by the remote control.

Function:

2.4Ghz Remote control with distance transmission until 20-30 meters working by 2 pic AAA battery (not included).

Features:

Up to 5 signal repeater devices can be added to increase the load controller by the single remote control.

CODICE: CODE:	TENSIONE IN INGRESSO: INPUT VOLTAGE:	CORRENTE IN USCITA: OUTPUT CURRENT:	POTENZA: POWER:	DIMENSIONI LxPxH: DIMENSION LxWxH:
09000	12 Vdc 24 Vdc	3 x 6 A 3 x 6 A	3 x 72W 3 x 144W	45 x 85 x 23 mm (controller) 52 x 110 x 20 mm (telecomando/ remote control)

OPZIONALE OPTIONAL

CODICE: CODE:	TENSIONE IN INGRESSO: INPUT VOLTAGE:	CORRENTE IN USCITA: OUTPUT CURRENT:	POTENZA: POWER:	DIMENSIONI LxPxH: DIMENSION LxWxH:
09001	12 Vdc 24 Vdc	4 x 3 A 4 x 3 A	4 x 36 W 4 x 72 W	46 x 105 x 28 mm



CONTROLLER PER LED RGB+W + REMOTE CONTROL

MAX 576W



Scheda tecnica
Datasheet



Descrizione:

Sistema di controllo RGB+W con telecomando in radio frequenza. Possibilità di controllare strip o moduli LED RGB+W in tensione costante in configurazione anodo comune. 15 Programmi pre impostati richiamabili in modo semplice e pratico dal telecomando.

Funzione:

Telecomando a 2.4Ghz con trasmissione fino a 20-30 metri funzionante tramite 2 batterie AAA (non incluse)

Caratteristiche:

Possibilità di aggiungere fino a 5 dispositivi ripetitori di segnale per aumentare il carico comandabile tramite il singolo telecomando.

Description:

RGB+W Control system with radio frequency remote control. Controlling RGB+W constant voltage strip or module in common anode configuration. 15 Pre setted programs easily recallable by the remote control.

Function:

204Ghz Remote control with distance trasmission until 20-30 meters working by 2 pic AAA battery (not included).

Features:

Up to 5 signal repeater devices can be added to increase the load controller by the single remote control.

CODICE: CODE:	TENSIONE IN INGRESSO: INPUT VOLTAGE:	CORRENTE IN USCITA: OUTPUT CURRENT:	POTENZA: POWER:	DIMENSIONI LxPxH: DIMENSION LxWxH:
09145	12 Vdc 24 Vdc	4 x 6 A 4 x 6 A	4 x 72W 4 x 144W	45 x 85 x 23 mm (controller) 52 x 110 x 20 mm (telecomando/ remote control)

OPZIONALE OPTIONAL

CODICE: CODE:	TENSIONE IN INGRESSO: INPUT VOLTAGE:	CORRENTE IN USCITA: OUTPUT CURRENT:	POTENZA: POWER:	DIMENSIONI LxPxH: DIMENSION LxWxH:
09041	12 Vdc 24 Vdc	4 x 2,5 A 4 x 2,5 A	4 x 30W 4 x 60W	53 x 88 x 26 mm



CONTROLLER PER LED RGB + CCT + REMOTE CONTROL

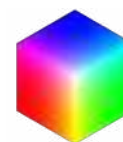

Scheda tecnica
Datasheet



Descrizione:

Sistema di controllo RGB+CCT con telecomando in radio frequenza. Possibilità di controllare strip o moduli LED RGB+CCT in tensione costante in configurazione anodo comune. 15 Programmi pre impostati richiamabili in modo semplice e pratico dal telecomando.

Funzione:

Telecomando a 2.4Ghz con trasmissione fino a 20-30 metri funzionante tramite 2 batterie AAA (non incluse)

Caratteristiche:

Possibilità di aggiungere fino a 5 dispositivi ripetitori di segnale per aumentare il carico comandabile tramite il singolo telecomando.

Description:

RGB+CCT Control system with radio frequency remote control. Controlling RGB+CCT constant voltage strip or module in common anode configuration. 15 Pre setted programs easily recallable by the remote control.

Function:

2.4Ghz Remote control with distance trasmission until 20-30 meters working by 2 pic AAA battery (not included).

Features:

Up to 5 signal repeater devices can be added to increase the load controller by the single remote control.

CODICE:

CODE:

09277

TENSIONE IN INGRESSO:

INPUT VOLTAGE:

12 Vdc

24 Vdc

CORRENTE IN USCITA:

OUTPUT CURRENT:

5 x 6 A

5 x 6 A

POTENZA:

POWER:

5 x 72W

5 x 144W

DIMENSIONI LxPxH:

DIMENSION LxWxH:

45 x 85 x 23 mm
(controller)

56 x 138 x 38 mm
(telecomando/
remote control)

COMPATIBLE 4 IN 1 PUSH DALI DT8 LED CONTROLLER



Scheda tecnica
Datasheet



Descrizione:

Sistema di controllo 4 in 1, dispositivo DALI DT8 per controllo RGBW o bianco dinamico sintonizzabili tramite un unico indirizzo DALI. Configurazione tramite interfaccia DALI master. Display digitale numerico per l'impostazione manuale dell'indirizzo DALI.

Funzione:

Controllo di quattro uscite PWM tramite dispositivo DALI tipo 8 e controllo del colore come definito nella specifica DALI dispositivo tipo 8.

Caratteristiche:

Solo 1 indirizzo necessario per controllare 4 uscite separatamente in modalità N primaria
4 Canali tensione costante o uscita corrente costante. Compatibile con interruttore a pressione universale AC.

Description:

4-in-1 control system, DALI DT8 device for RGBW control or dynamic white tuned via a single DALI address. Configuration via master DALI interface. Digital numeric display for manual DALI address setting.

Function:

Control of four PWM outputs via type 8 DALI device and color control as defined in DALI device specification type 8.

Features:

Only 1 address needed to control 4 outputs separately in primary N mode
4 Channels constant voltage or constant current output. Compatible with AC universal pressure switch.

CODICE:
CODE:

09353

TENSIONE IN INGRESSO:

INPUT VOLTAGE:

12 Vdc

24 Vdc

CORRENTE IN USCITA:

OUTPUT CURRENT:

4 x 5 A

4 x 5 A

POTENZA:

POWER:

4 x 60W

4 x 120W

DIMENSIONI LxPxH:

DIMENSION LxWxH:

53,4 x 170 x 28 mm

MINI DIMMER BLUETOOTH PUSH MONO



Scheda tecnica
Datasheet



Descrizione:

Regolatore di luminosità per alimentatori in tensione a 12-24-48 VDC che offre una soluzione semplice ed efficace per la regolazione dell'intensità luminosa di moduli e strisce a led in bassa tensione.

Funzione:

La centralina viene comandata tramite interfaccia BLUETOOTH e/o a pulsante normalmente aperto per comando locale. Funzionamento in BLUETOOTH tramite la app BLUEDIMMER scaricabile gratuitamente da Applestore o Android Market.

Caratteristiche:

Le sue piccole dimensioni rendono il dispositivo di facile installazione. Compatibile con scatola standard o fissaggio a muro.

Description:

Dimmer for power supply 12-24-48VDC that offers a simple and effective solution for regulating the brightness of low voltage monocromatic LED strips and modules.

Function:

The device is commanded by BLUETOOTH interface and/or with a Normally Open pushbutton for local command (not included). Operating in BLUETOOTH by the BLUEDIMMER app that can be free downloaded from Applestore or Android Market.

Features:

Its compact size makes the device easy to install. Compatible with a standard box or for wall mounting.



CODICE:

CODE:

09286

TENSIONE IN INGRESSO:

INPUT VOLTAGE:

12 Vdc

24 Vdc

48 Vdc

CORRENTE IN USCITA:

OUTPUT CURRENT:

8 A

8 A

8 A

POTENZA:

POWER:

96W

192W

384W

DIMENSIONI LxPxH:

DIMENSION LxWxH:

44 x 44 x 25 mm

CONTROLLER BLUETOOTH/PUSH - MONOCROMATICO-BIANCO DINAMICO/RGB/RGB+W



Scheda tecnica
Datasheet



Descrizione:

Regolatore di luminosità per alimentatori in tensione a 12-24 Vdc che offre una soluzione semplice ed efficace per la regolazione dell'intensità luminosa di moduli e strisce a led RGB, RGB+W, bianco dinamico e monocromatiche in bassa tensione.

Funzione:

- Bluetooth tramite la app BLUEDIMMER scaricabile gratuitamente da Applestore o Android Market.
 - Pulsanti normalmente aperti per comando locale (non compresi)
- La modalità di funzionamento è selezionata attraverso il DIP-SWITCH.

Caratteristiche:

Possibilità di aggiungere fino a 5 dispositivi ripetitori di segnale per aumentare il carico comandabile tramite il singolo telecomando.

Description:

Dimmer for power supply 12-24Vdc that offers a simple and effective solution for regulating the brightness of low voltage RGB, RGB+W, dynamic white and monocromatic strips and modules.

Function:

- Bluetooth by the BLUEDIMMER app that can be free downloaded from Applestore or Android Market
- Normally Open pushbuttons for local command.(not included).
- The operating mode is selected via the DIP SWITCH.

Features:

Up to 5 signal repeater devices can be added to increase the load controlled via the single remote control.

CODICE: CODE:	TENSIONE IN INGRESSO: INPUT VOLTAGE:	CORRENTE IN USCITA: OUTPUT CURRENT:	POTENZA: POWER:	DIMENSIONI LxPxH: DIMENSION LxWxH:
09287	12 Vdc 24 Vdc	4 x 2,5 A 4 x 2,5 A	4 x 30W 4 x 60W	53 x 88 x 26 mm

OPZIONALE OPTIONAL

CODICE: CODE:	TENSIONE IN INGRESSO: INPUT VOLTAGE:	CORRENTE IN USCITA: OUTPUT CURRENT:	POTENZA: POWER:	DIMENSIONI LxPxH: DIMENSION LxWxH:
09041	12 Vdc 24 Vdc	4 x 2,5 A 4 x 2,5 A	4 x 30W 4 x 60W	53 x 88 x 26 mm



DIMMER CASAMBI/PUSH - MONOCROMATICO- BIANCO DINAMICO/RGB/RGB+W



Scheda tecnica
Datasheet



Descrizione:

Regolatore di luminosità per alimentatori in tensione a 12-24 Vdc che offre una soluzione semplice ed efficace per la regolazione dell'intensità luminosa di moduli e strisce a led RGB, RGB+W, bianco dinamico e monocromatiche in bassa tensione.

Caratteristiche:

- CASAMBI tramite la app CASAMBI scaricabile gratuitamente da Applestore o Android Market.
- n°4 Pulsanti normalmente aperti (non compresi) per richiamare scenari

Description:

Dimmer for power supply 12-24Vdc that offers a simple and effective solution for regulating the brightness of low voltage RGB, RGB+W, dynamic white and monocromatic strips and modules.

Function:

- CASAMBI by the CASAMBI app that can be free downloaded from Applestore or Android Market
- 4 Normally Open pushbuttons (not included) for recall scenary

CODICE: CODE:	TENSIONE IN INGRESSO: INPUT VOLTAGE:	CORRENTE IN USCITA: OUTPUT CURRENT:	POTENZA: POWER:	DIMENSIONI LxPxH: DIMENSION LxWxH:
09295	12 Vdc 24 Vdc	4 x 2,5 A 4 x 2,5 A	4 x 30W 4 x 60W	53 x 88 x 26 mm

OPZIONALE OPTIONAL

CODICE: CODE:	TENSIONE IN INGRESSO: INPUT VOLTAGE:	CORRENTE IN USCITA: OUTPUT CURRENT:	POTENZA: POWER:	DIMENSIONI LxPxH: DIMENSION LxWxH:
09041	12 Vdc 24 Vdc	4 x 2,5 A 4 x 2,5 A	4 x 30W 4 x 60W	53 x 88 x 26 mm



CONTROLLER TOUCH + DMX512 CAPACITIVE TUNABLE WHITE



Scheda tecnica
Datasheet



Descrizione:

Regolatore di luminosità per alimentatori in tensione a 12-24 Vdc touch capacitivo per Strip o moduli LED bianco dinamico in bassa tensione.
Con **generatore di segnale DMX512**.

Funzione:

- 6 livelli di tonalità preimpostati.
- Scelta tonalità tramite ruota colori.
- Dimmerazione luminosità.

Caratteristiche:

Adatto per scatole di derivazione standard 503.

Description:

Brightness regulator for 12-24 Vdc capacitive touch voltage power supplies for Strip or dynamic white LED modules in low voltage.

With **DMX512 signal generator**.

Function:



- 6 preset tone levels.
- Choice of colour by colour wheel.
- Dimming of brightness.

Features:

Suitable for junction boxes standard 503.

CODICE: CODE:	TENSIONE IN INGRESSO: INPUT VOLTAGE:	CORRENTE IN USCITA: OUTPUT CURRENT:	POTENZA: POWER:	SEGNALE IN USCITA: OUTPUT SIGNAL:	DIMENSIONI LxPxH: DIMENSION LxWxH:
09309	12 Vdc	3 x 5 A	3 x 60W	DMX512	120 x 80 x 11 mm
	24 Vdc	3 x 5 A	3 x 120W	DMX512	
					DIMENSIONI LxPxH: DIMENSION LxWxH:

OPZIONALE OPTIONAL

CODICE: CODE:	TENSIONE IN INGRESSO: INPUT VOLTAGE:	CORRENTE IN USCITA: OUTPUT CURRENT:	POTENZA: POWER:	DIMENSIONI LxPxH: DIMENSION LxWxH:
CONTROLLER MULTIDIMMER: PUSH/0-10V/0-5V/DMX512 (VOLTAGE)				
09325 	12 Vdc	4 x 5 A	4 x 60W	92 x 72 x 62 mm
	24 Vdc	4 x 5 A	4 x 120W	
	48 Vdc	4 x 5 A	4 x 240W	
CONTROLLER MULTIDIMMER: PUSH/0-10V/0-5V/DMX512 (CURRENT)				
09171 	12 Vdc	4 x 350/500/700 mA	16/24/33 W	92 x 72 x 62 mm
	24 Vdc	4 x 350/500/700 mA	16/24/33 W	
	48 Vdc	4 x 350/500/700 mA	16/24/33 W	

CONTROLLER TOUCH CAPACITIVE RGB / RGB + W



Scheda tecnica
Datasheet



Descrizione:

Regolatore di luminosità per alimentatori in tensione a 12-24 Vdc touch capacitivo per strip o moduli LED RGB e RGB+W in bassa tensione con **generatore di segnale DMX512**.

Funzione:

20 Programmi pre impostati richiamabili.

Possibilità di aggiungere fino a 5 dispositivi ripetitori di segnale per aumentare il carico comandabile tramite il singolo touch.

Caratteristiche:

Adatto per scatole di derivazione standard 503.

Description:

Brightness regulator for live 12-24 Vdc touch capacitors for strips or low voltage RGB+W LED modules and **generator DMX512 signal**.

Functions:



20 Pre-set programs can be recalled easily. Up to 5 signal repeater devices can be added to increase the load via the single TOUCH.

Features:

Suitable for standard 503 branch boxes

CODICE: CODE:	TENSIONE IN INGRESSO: INPUT VOLTAGE:	CORRENTE IN USCITA: OUTPUT CURRENT:	POTENZA: POWER:	SEGNALE IN USCITA: OUTPUT SIGNAL:	DIMENSIONI LxPxH: DIMENSION LxWxH:
09042	12 Vdc 24 Vdc	4 x 5 A 4 x 5 A	4 x 60W 4 x 120W	DMX512 DMX512	120 x 80 x 11 mm

OPZIONALE OPTIONAL

CODICE: CODE:	TENSIONE IN INGRESSO: INPUT VOLTAGE:	CORRENTE IN USCITA: OUTPUT CURRENT:	POTENZA: POWER:	DIMENSIONI LxPxH: DIMENSION LxWxH:
CONTROLLER MULTIDIMMER: PUSH/0-10V/0-5V/DMX512 (VOLTAGE)				
09325	 12 Vdc 24 Vdc 48 Vdc	4 x 5 A 4 x 5 A 4 x 5 A	4 x 60W 4 x 120W 4 x 240W	92 x 72 x 62 mm
CONTROLLER MULTIDIMMER: PUSH/0-10V/0-5V/DMX512 (CURRENT)				
09171	 12 Vdc 24 Vdc 48 Vdc	4 x 350/500/700 mA 4 x 350/500/700 mA 4 x 350/500/700 mA	16/24/33 W 16/24/33 W 16/24/33 W	92 x 72 x 62 mm

CONTROLLER TOUCH + DMX512 4CH



Scheda tecnica
Datasheet



Descrizione:

Touch panel DMX a 4 zone adatto per il comando di centraline DMX per stripLED o moduli LED RGB+W in bassa tensione.

Funzione:

Genera il segnale DMX512 per comandare 4 zone separatamente o insieme.
10 Programmi pre impostati richiamabili in modo semplice e pratico.

Caratteristiche:

Adatto per scatole di derivazione standard 503.

Description:

DMX 4-zone touch panel suitable to control DMX control units for stripLED or Low voltage RGB + W LED modules.

Function:

Generate the DMX512 signal to control 4 zones separately or together.
10 Pre-set programs that can be called up in a simple and practical way.

Features:

Suitable for junction boxes standard 503.

CODICE: CODE:	TENSIONE IN INGRESSO: INPUT VOLTAGE:	CORRENTE IN USCITA: OUTPUT CURRENT:	SEGNALE IN USCITA: OUTPUT SIGNAL:	DIMENSIONI LxPxH: DIMENSION LxWxH:
09330	12 Vdc 24 Vdc	- -	DMX512 DMX512	120 x 80 x 29,2 mm

OPZIONALE OPTIONAL

CODICE: CODE:	TENSIONE IN INGRESSO: INPUT VOLTAGE:	CORRENTE IN USCITA: OUTPUT CURRENT:	POTENZA: POWER:	DIMENSIONI LxPxH: DIMENSION LxWxH:
CONTROLLER MULTIDIMMER: PUSH/0-10V/0-5V/DMX512 (VOLTAGE)				
09325	12 Vdc 24 Vdc 48 Vdc	4 x 5 A 4 x 5 A 4 x 5 A	4 x 60W 4 x 120W 4 x 240W	92 x 72 x 62 mm
CONTROLLER MULTIDIMMER: PUSH/0-10V/0-5V/DMX512 (CURRENT)				
09171	12 Vdc 24 Vdc 48 Vdc	4 x 350/500/700 mA 4 x 350/500/700 mA 4 x 350/500/700 mA	16/24/33 W 16/24/33 W 16/24/33 W	92 x 72 x 62 mm



Descrizione:

Centralina per comando della luce con comando vocale o via App tramite Wi-Fi per smartphone, per alimentatori in tensione a 12-24VDC che offre una soluzione per la regolazione dell'intensità luminosa di moduli e strisce a LED bianco dinamico, RGB , RGBW in bassa tensione.
Controllo tramite sistema(non incluso) Alexa/Google Home oppure tramite applicazione TUYA SMART.

Funzioni Vocali:

Accensione/spengimento. Regolazione della luminosità a percentuale. Regolazione della temperatura colore (Per Bianco Dinamico). Regolazione del colore (colori predefiniti per RGB o RGBW)

Funzioni via App:

Accensione/spengimento.Regolazione della luminosità.Regolazione della temperatura colore tramite barra dedicata (Per Bianco Dinamico). Regolazione del colore tramite ruota colori (Per RGB o RGBW).

Description:

Control unit for light control with voice command or via App through Wi-Fi for smartphones, for 12-24VDC power supplies for a solution for adjusting the light intensity of dynamic white LED RGB RGBW RGB low voltage modules and strips.
Control via Alexa / Google Home system or through TUYA SMART application.

Vocal functions:

Power on / off. Percentage brightness adjustment. Color temperature adjustment (for Dynamic White).
Color adjustment (default colors for RGB or RGBW).

Functions via App:

Power on / off. Brightness adjustment. Color temperature adjustment via dedicated bar (For White Dynamic).
Color adjustment via color wheel (For RGB or RGBW).

CODICE: CODE:	TENSIONE IN INGRESSO: INPUT VOLTAGE:	CORRENTE IN USCITA: OUTPUT CURRENT:	POTENZA: POWER:	DIMENSIONI LxPxH: DIMENSION LxWxH:
09346	12 Vdc	4 x 0,875 A	120W	104 x 43 x 23 mm
	24 Vdc	3 x 1,16 A	120W	
	48 Vdc	2 x 1,75 A	120W	

OPZIONALE OPTIONAL

CODICE: CODE:	TENSIONE IN INGRESSO: INPUT VOLTAGE:	CORRENTE IN USCITA: OUTPUT CURRENT:	POTENZA: POWER:	DIMENSIONI LxPxH: DIMENSION LxWxH:
09041	12 Vdc	4 x 2,5 A	4 x 30W	53 x 88 x 26 mm
	24 Vdc	4 x 2,5 A	4 x 60W	



CONTROLLER MULTIDIMMER: PUSH/0-10V/0-5V/DMX512 MONOCROMATICO/TUNABLE WHITE/RGB/RGB+W



Scheda tecnica
Datasheet



Descrizione:

Regolatore di luminosità per alimentatori in tensione a 12-24-48 VDC che offre una soluzione efficace per la regolazione dell'intensità luminosa di moduli e strisce a led RGB, RGB+W, Bianco dinamico e monocromatico in bassa tensione.

Funzione:

- Pulsanti normalmente aperti (non compresi)(non per versione RGBW)
- Ingressi analogici 0..10V e 0..5V (solo per il funzionamento monocromatico,RGB e Bianco dinamico)
- Potenziometro (non compreso)
- DMX512 (master DMX non compreso)

Caratteristiche:

La modalità di funzionamento è impostabile tramite i selettori. Possibilità di collegare incascata più dispositivi.

Description:

Brightness regulator for 12-24-48 VDC voltage power supplies that offers an effective solution for adjusting the light intensity of RGB, RGB+W, dynamic white and monochrome modules and strips in low voltage.

Function:

- Buttons normally open (not included)(not for RGBW version)
- Analog inputs 0.. 10V and 0.. 5V (only for monochrome operation, RGB and Dynamic White)
- Potentiometer (not included)
- DMX512 (DMX master not included)

Features:

The operation mode can be set via selectors. Possibility to connect multiple devices.

CODICE: CODE:	TENSIONE IN INGRESSO: INPUT VOLTAGE:	CORRENTE IN USCITA: OUTPUT CURRENT:	POTENZA: POWER:	DIMENSIONI LxPxH: DIMENSION LxWxH:
09171	12 Vdc	4 x 350/500/700 mA	16/24/33 W	110 x 70 x 62 mm
	24 Vdc	4 x 350/500/700 mA	33/48/67 W	
	48 Vdc	4 x 350/500/700 mA	66/96/134 W	

OPZIONALE OPTIONAL

CODICE: CODE:	TENSIONE IN INGRESSO: INPUT VOLTAGE:	CORRENTE IN USCITA: OUTPUT CURRENT:	SEGNALE IN USCITA: OUTPUT SIGNAL:	DIMENSIONI LxPxH: DIMENSION LxWxH:
RADIO FREQUENCY DMX FOR RGB+W				
09085	12 Vdc	-	DMX 512	45 x 107 x 24 mm
	24 Vdc	-	DMX 512	39 x 73 x 16 mm
SLAVE CONTROL UNITS				
09043	12 Vdc	4 x 350/500/700 mA		53 x 88 x 26 mm
	24 Vdc	4 x 350/500/700 mA		
	48 Vdc	4 x 350/500/700 mA		
DMX TOUCH PANEL 503 FOR RGB+W				
09042	12 Vdc	-	DMX 512	120 x 80 x 11mm
	24 Vdc	-	DMX 512	

CONTROL SYSTEM RGB PUSH



Scheda tecnica
Datasheet

**Descrizione:**

Sistema di controllo RGB tramite un pulsante normalmente aperto.

Funzione:

Possibilità di controllare moduli Led RGB in corrente costante (350mA).

Caratteristiche:

Possibilità di aggiungere fino a 9 dispositivi ripetitori di segnale per aumentare il carico comandabile tramite il singolo telecomando.

Description:

RGB Control System with a pushbottom normally open.

Function:

Controlling RGB constant current module (350mA).

Features:

Up to 9 signal repeater devices can be added to increase the load controlled via the single remote control.

CODICE:
CODE:

09180

TENSIONE IN INGRESSO:

INPUT VOLTAGE:

220 Vac

CORRENTE IN USCITA:

OUTPUT CURRENT:

3 x 350 mA

POTENZA:

POWER:

3 x 10,8 W

DIMENSIONI LxPxH:

DIMENSION LxWxH:

75 x 146 x 29 mm

CONTROLLER RGB CURRENT REMOTE CONTROL



Scheda tecnica
Datasheet



Descrizione:

Sistema di controllo RGB con telecomando e ricevitore infrarossi. Possibilità di controllare moduli LED RGB in corrente costante (350mA)

Funzione:

Telecomando a 2.4Ghz con trasmissione fino a 20-30 metri funzionante tramite 3 batterie AAA (non incluse)

Caratteristiche:

Possibilità di aggiungere fino a 9 dispositivi ripetitori di segnale per aumentare il carico comandabile tramite il singolo telecomando

Description:

RGB Control System with radio frequency remote control. Controlling RGB constant current module in common anode configuration.

Function:

2,4 Ghz Remote control with distance transmission until 20-30 meters working by 3AAA battery (not included)

Features:

Up to 9 signal repeater devices can be added to increase the load controlled via the single remote control..



CODICE: CODE:	TENSIONE IN INGRESSO: INPUT VOLTAGE:	CORRENTE IN USCITA: OUTPUT CURRENT:	POTENZA: POWER:	DIMENSIONI LxPxH: DIMENSION LxWxH:
09010	220 Vac	3 x 350 mA	3 x 10,8W	75 x 146 x 29 mm (controller) 34 x 122 x 20 mm (ricevitore / receiver)

OPZIONALE OPTIONAL

CODICE: CODE:	TENSIONE IN INGRESSO: INPUT VOLTAGE:	CORRENTE IN USCITA: OUTPUT CURRENT:	POTENZA: POWER:	DIMENSIONI LxPxH: DIMENSION LxWxH:
09180	220 Vdc	3x350 mA	3 x 10,8 W	75 x 146 x 29 mm



RADIO FREQUENCY DMX FOR RGB+W

CONTROLLER GATEWAY - ZIGBEE PER MONOCOLRE E RGB



Scheda tecnica
Datasheet



I dispositivi ZigBee vantano un gran numero di applicazioni: sono ideali per una rete informatica casalinga e vengono utilizzati per i sistemi di sicurezza intelligenti per la casa ed elettrodomestici automatici.

La centralina gateway:

- Gateway compatibile con tutte le interfacce a protocollo ZigBee
- APP Android e IOS gratuita per smartphone e tablet
- Protocollo radio: ZigBee PRO
- Interfaciabile tramite Home network o smartphone

Zigbee devices boast a large number of applications: they are ideal for a home computer network and are used for smart home security systems and automatic appliances.

The gateway control unit:

- Gateway compatible with all zigbee protocol interfaces
- Free Android and IOS apps for smartphones and tablets
- Radio protocol: zigbee PRO
- Interface via home network or smartphone

CODICE:
CODE:

09002

TENSIONE IN INGRESSO:
INPUT VOLTAGE:

12 Vdc

CORRENTE IN USCITA:
OUTPUT CURRENT:

ZIGBEE SIGNAL

RADIOFREQUENZA:
RADIOFREQUENCY:

2.4 GHz

DIMENSIONI LxPxH:
DIMENSION LxWxH:

110 x 85 x 24,2 mm

RGB+W - DIMMER RGB+W



Scheda tecnica
Datasheet



Descrizione:

- Interfaccia compatibile con tutte le apparecchiature a protocollo ZigBee 3.0.
- Funzioni On-Off / dimmer.
- Gestione RGB+W separato.
- Compatibile con i prodotti gateway ZigBee 3.0 universali.
- Supporta una rete ZigBee self-forming senza coordinatore.
- Supporta green-power zigbee e può associare max. 20 apparecchiature ZigBee.

Description:

- Interface compatible with all zigbee 3.0 protocol equipment.
- On-Off functions / dimmer.
- Separate RGB+W management.
- Compatible with universal zigbee 3.0 gateway products.
- Supports zigbee self-forming network without coordinator.
- Supports green-power zigbee and can associate max. 20 zigbee equipment.

CODICE: CODE:	TENSIONE IN INGRESSO: INPUT VOLTAGE:	CORRENTE IN USCITA: OUTPUT CURRENT:	POTENZA: POWER:	DIMENSIONI LxPxH: DIMENSION LxWxH:
09004	12 Vdc 24 Vdc	4 x 5 A 4 x 5 A	240 W 480 W	167 x 57 x 29 mm

OPZIONALE OPTIONAL

RGB+W - REMOTE CONTROL



- Radiocomando ZigBee RGB/RGBW
- Batteria 4.5Vdc.
- Radiofrequenza 2.4GHz.
- Comando per 4 zone separate con un massimo di 30 dispositivi ZigBee.
- Associazione e ricerca dispositivi manuale.

- Zigbee remote control RGB/RGBW
- 4.5vdc battery.
- Radio frequency 2.4ghz.
- Control for 4 separate zones with up to 30 zigbee devices.
- Manual device pairing and searching.

CODICE: CODE:	BATTERIA: BATTERY:	RADIOFREQUENZA: RADIOFREQUENCY:	DIMENSIONI LxPxH: DIMENSION LxWxH:
09005	4,5 V	2,4 GHz	120 x 55 x 17 mm

MONOCOLORE - DIMMER MONOCROMATIC RADIO/PUSH



Scheda tecnica
Datasheet



Descrizione:

- Intefaccia compatibile con tutte apparecchiature a protocollo ZigBee 3.0
- Funzioni On-Off e dimmer
- Compatibile con tutti i gateway ZigBee 3.0 universali
- Supporta una rete ZigBee self-forming senza coordinatore

Description:

- Head compatible with all zigbee protocol 3.0 equipment
- On-Off functions and dimmers
- Compatible with all universal zigbee 3.0 gateways
- Supports zigbee self-forming network without coordinator

CODICE: CODE:	TENSIONE IN INGRESSO: INPUT VOLTAGE:	CORRENTE IN USCITA: OUTPUT CURRENT:	POTENZA: POWER:	DIMENSIONI LxPxH: DIMENSION LxWxH:
09003	12 Vdc 24 Vdc	4 x 5 A 4 x 5 A	240 W 480 W	98 x 38 x 20 mm

OPZIONALE OPTIONAL

MONOCOLORE - REMOTE CONTROL



- Radiocomando ZigBee a colore singolo.
- Batteria 4.5Vdc.
- Radiofrequenza 2.4GHz.
- Comando per 4 zone separate con un massimo di 30 dispositivi ZigBee.
- Associazione e ricerca dispositivi manuale.

- Single colour zigbee remote control.
- 4.5vdc battery.
- Radio frequency 2.4ghz.
- Control for 4 separate zones with up to 30 zigbee devices.
- Manual device pairing and searching.

CODICE: CODE:	BATTERIA: BATTERY:	RADIOFREQUENZA: RADIOFREQUENCY:	DIMENSIONI LxPxH: DIMENSION LxWxH:
09006	4,5 V	2,4 GHz	120 x 55 x 17 mm

CONTROLLER STRIP LED PIXEL RGB + W

CONTROLLER BLUETOOTH

Descrizione:

Sistema di controllo Bluetooth.

Possibilità di controllare stripLED RGB - RGB+W - e monocromatiche di tipo digitale via Smartphone o con App.

Funzione:

- Bluetooth tramite la app BLUEDIMMER scaricabile gratuitamente da Applestore o Android Market.

-Regolazione tramite App della luminosità, scelta tra 200 Scene pre-impostate.

Caratteristiche:

Controllo di massimo 2048 pixelsLED

Description:

Bluetooth control system.

Possibility to control RGB stripLED - RGB+W - and digital monochrome via Smartphone or with App.

Function:

- Bluetooth via the BLUEDIMMER app downloadable free of charge from Applestore or Android Market.

-App brightness adjustment, choose from 200 Preset scenes.

Features:

Maximum control 2048 pixelsLED



Scheda tecnica
Datasheet

CODICE:
CODE:

09347

TENSIONE IN INGRESSO:

INPUT VOLTAGE:

5-12 Vdc

CORRENTE IN USCITA:

OUTPUT CURRENT:

28-40 mA

DIMENSIONI LxPxH:

DIMENSION LxWxH:

45 x 85 x 23 mm

CONTROLLER VIA SD CARD / CONTROLLER BY SD CARD

Descrizione:

Sistema di controllo via sd Card programmabile da computer.

Possibilità di controllare stripLED RGB - RGB+W - e monocromatiche di tipo digitale via SD Card programmata tramite LEDEdit scaricabile da internet.

Funzione:

Richiama programmi realizzabili tramite LEDEdit oppure programmi pre installati tramite il tasto mode.

Regolazione velocità della scena tramite i tasti Speed+ e speed.

Caratteristiche:

Controllo di massimo 2048 pixelsLED. Massimo 16 programmi impostabili.

Description:

Control system via sd Card programmable by computer. Possibility to control RGB - RGB+W - and digital monochrome strips via SD Card programmed via LEDEdit downloadable from internet.

Function:

Call programs that can be created via LEDEdit or programs that are already installed via the mode button.

Scene speed adjustment via Speed+ and Speed keys.

Features:

Maximum control 2048 pixelsLED. Maximum 16 programs can be set.



Scheda tecnica
Datasheet

CODICE:
CODE:

09348

TENSIONE IN INGRESSO:

INPUT VOLTAGE:

5-12 Vdc

CORRENTE IN USCITA:

OUTPUT CURRENT:

28-40 mA

DIMENSIONI LxPxH:

DIMENSION LxWxH:

165 x 80 x 30 mm

CONTROLLER CON RADIO COMANDO / CONTROLLER WITH REMOTE CONTROL

Descrizione:

Sistema di controllo con radio comando. Possibilità di controllare stripLED RGB - RGB+W di tipo digitale via radio.

Funzione:

ON/OFF, scelta delle modalità scenario (32 scenari preimpostati), regolazione velocità scenario, regolazione, luminosità scenario, scelta della tipologia di Strip Digitale utilizzata.

Caratteristiche:

Controllo di massimo 2048 pixelsLED. Distanza di controllo del radiocomando 30-50m.

Description:

Control system with radio control. Possibility to control RGB - RGB+W digital stripes via radio.

Function:

ON/OFF, choice of scenario modes (32 preset scenarios), setting speed scenario, setting brightness adjustment, choice of type of digital strip used.

Features:

Maximum control 2048 pixelsLED. Remote control distance 30-50m.



Scheda tecnica
Datasheet

CODICE:
CODE:

09349

TENSIONE IN INGRESSO:

INPUT VOLTAGE:

5-12 Vdc

CORRENTE IN USCITA:

OUTPUT CURRENT:

10A max

DIMENSIONI LxPxH:

DIMENSION LxWxH:

135 x 30 x 20 mm

135 x 40 x 14 mm (telecomando/remote control)

RILEVATORE DI PRESENZA PIR PIR PRESENCE DETECTOR

**Descrizione:**

Rilevatore di presenza passivo ad infrarossi. Il sensore rileva e si attiva a cambiamenti di temperatura provocati dal passaggio davanti all'ottica di persone o oggetti con una temperatura di 35-36°

Caratteristiche:

Adatto per il montaggio in profili lineari ELCOM

Description:

Passive infrared presence detector. The sensor detects and activates temperature changes caused by the passage or objects with a temperature of 35-36° in front of the lens.

Features:

Suitable for mounting in ELCOM linear profiles



Scheda tecnica
Datasheet

CODICE:
CODE:

03102

TENSIONE IN INGRESSO:
INPUT VOLTAGE:

12 - 24 Vdc

CORRENTE IN USCITA:
OUTPUT CURRENT:

12 - 24 Vdc

POTENZA:
POWER:

18 - 36 W

DIMENSIONI LxPxH:
DIMENSION LxWxH:

50 x 11,2 x 11,5 mm

DIMMER TOUCH ON/OFF/DIMMER DIMMER TOUCH ON/OFF/DIMMER

**Descrizione:**

Dispositivo da inserire tra l'alimentazione e la strip LED in tensione costante per effettuare accensione, spegnimento e dimmerazione della luce.

Caratteristiche:

Adatto per il montaggio in profili lineari ELCOM.

Description:

Device to be inserted between power supply and the LED strip for turn on, turn off and dimmer the light.

Features:

Suitable for mounting in ELCOM linear profiles



Scheda tecnica
Datasheet

CODICE:
CODE:

14071

TENSIONE IN INGRESSO:
INPUT VOLTAGE:

12 - 24 Vdc

CORRENTE IN USCITA:
OUTPUT CURRENT:

12 - 24 Vdc

POTENZA:
POWER:

36 - 72 W

DIMENSIONI LxPxH:
DIMENSION LxWxH:

42 x 10 mm

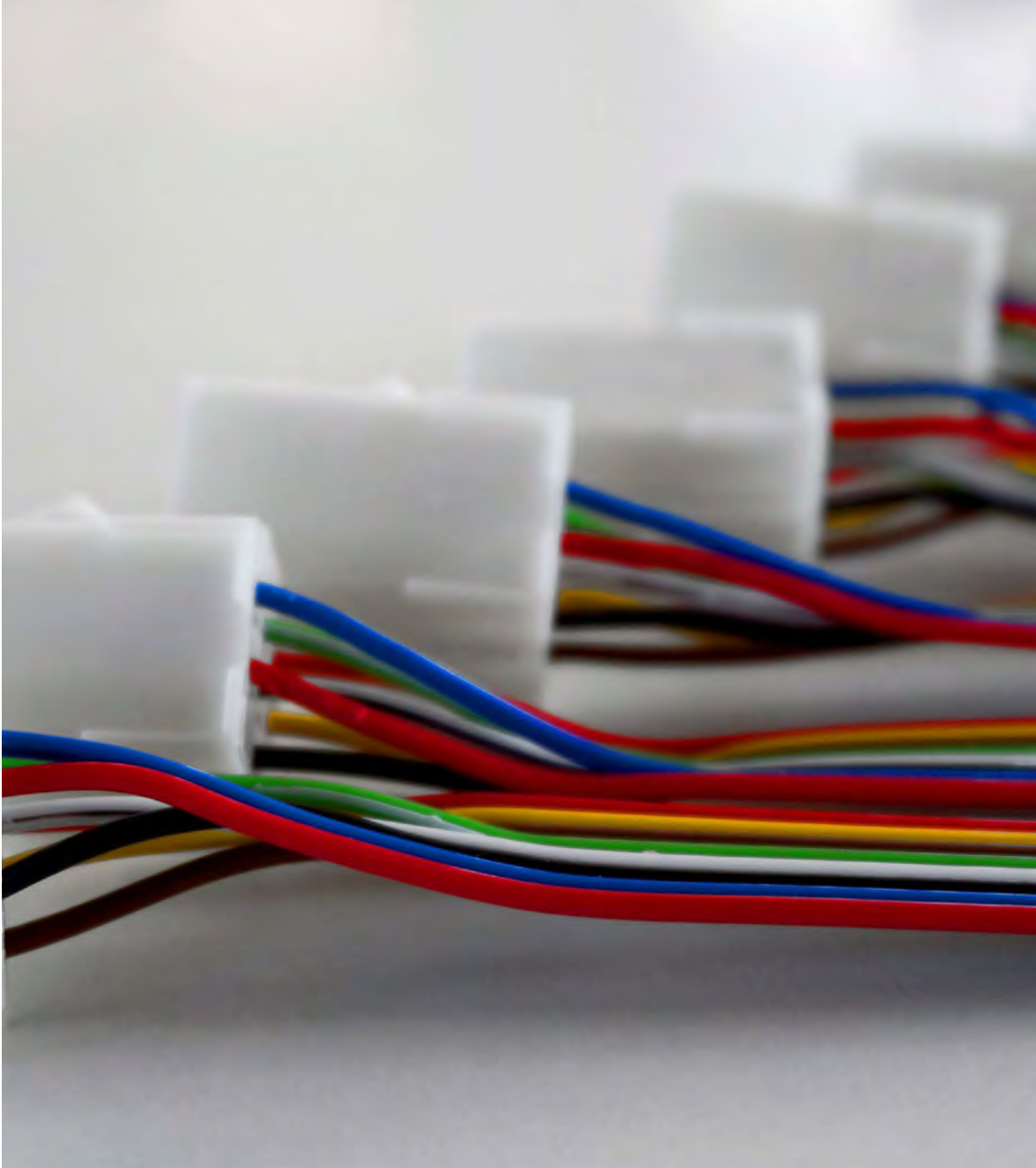

DIMMER MONO CHANNEL PUSH/BLUETOOTH/ZIGBEE 3.0 24Vdc Z-DIM24

ZQ



Scheda tecnica
Datasheet



Dimmer LED singolo canale a tensione costante. Ingresso 24Vdc, uscita PWM max 11A@24V.
Controllo tramite pulsante. Wireless mesh network 2.4 GHz Bluetooth LE/Zigbee 3.0 compatibile.

Constant voltage single channel LED dimmer. 24Vdc input, PWM output max 11A@24V.
Control via push button. 2.4 GHz wireless mesh network Bluetooth LE/Zigbee 3.0 compatible.



BANDA DI FREQUENZA 2.4 GHz
FREQUENCY BAND 2.4 GHz

FOR EU MARKETS ONLY

CODICE: CODE:	TENSIONE IN INGRESSO: INPUT VOLTAGE:	CORRENTE IN USCITA: OUTPUT CURRENT:	POTENZA: POWER:	CONTROLLO IN INGRESSO: CONTROL INPUT:	DIMENSIONI LxPxH: DIMENSION LxWxH:
ZQ20-04R0 (Z-DIM24)	24 Vdc	max 11A	264W	PUSH BLUETOOTH LE ZIGBEE 3.0	41 x 47 x 20 mm

DIMMER MONO CHANNEL PUSH/BLUETOOTH/ZIGBEE 3.0 48Vdc Z-DIM48

ZQ



Scheda tecnica
Datasheet



Dimmer LED singolo canale a tensione costante. Ingresso 24/48Vdc, uscita PWM max 7A@24/48V. Controllo tramite pulsante. Wireless meshnetwork 2.4 GHz Bluetooth LE/Zigbee 3.0 compatibile.

Constant voltage single channel LED dimmer. 24/48Vdc input, PWM output max 7A@24/48V. Control via push button. 2.4 GHz wireless mesh network Bluetooth LE/Zigbee 3.0 compatible.



BANDA DI FREQUENZA 2.4 GHz
FREQUENCY BAND 2.4 GHz

FOR EU MARKETS ONLY

CODICE: CODE:	TENSIONE IN INGRESSO: INPUT VOLTAGE:	CORRENTE IN USCITA: OUTPUT CURRENT:	POTENZA: POWER:	CONTROLLO IN INGRESSO: CONTROL INPUT:	DIMENSIONI LxPxH: DIMENSION LxWxH:
ZQ20-05R0 (Z-DIM48)	24-48 Vdc	max 7A	168-336W	PUSH BLUETOOTH LE ZIGBEE 3.0	41 x 47 x 20 mm

CONTROLLER WIRELESS 2.4 GHz Z-NB18



Scheda tecnica
Datasheet



Controller wireless Mesh Network 2.4 GHz Bluetooth LE/Zigbee compatibile. Sistema di connessione Zhaga Book 18. Gestisce in regolazione fino a 4 driver standard DALI. Alimentazione autosensing da 24Vdc oppure da linea DALI secondo le specifiche DALI-2 D4i. Versione MASTER con GPS, RTC e sensore di luminosità integrati.

Bluetooth LE/Zigbee compatible Mesh Network 2.4 GHz wireless controller. Zhaga Book 18 connector system. It manages up to 4 standard DALI drivers in regulation. Autosensing power supply between 24Vdc or DALI bus according to D4i DALI-2 specification. MASTER version with integrated GPS, RTC and light sensor.



BANDA DI FREQUENZA 2.4 GHz
FREQUENCY BAND 2.4 GHz

FOR EU MARKETS ONLY

CODICE: CODE:	TENSIONE IN INGRESSO: INPUT VOLTAGE:	SENSORE DI LUMINOSITÀ: LIGHT SENSOR:	USCITA DI CONTROLLO: CONTROL OUTPUT:	DIMENSIONI LxPxH: DIMENSION LxWxH:
ZQ12-00R0 (Z-NB18-S)	Autosensing 24 Vdc Bus DALI-2 (D4i)	-	max 4 driver DALI-2 (D4i)	Ø80 x 34 mm
ZQ12-01R0 (Z-NB18-M)	Autosensing 24 Vdc Bus DALI-2 (D4i)	Range 3-300 lux	max 4 driver DALI-2 (D4i)	Ø80 x 34 mm

CONTROLLER WIRELESS 868 MHz RFxLT



Scheda tecnica
Datasheet



Controller wireless Mesh Network 868 MHz Long Range (16 dBm).
Gestisce in regolazione da 8 a 32 driver standard DALI (broadcast o indirizzati) o 1/10V, uscita relè a contatto pulito normalmente chiusa (max 500VA). Alimentazione 24Vdc.
Grado di protezione IP20 con scheda tropicalizzata. Connettore SMA per antenna esterna (esclusa).

Long Range (16 dBm) 868 MHz Wireless Mesh Network Controller. It manages from 8 to 32 standard DALI (broadcast or addressed) or 1/10V drivers in regulation, dry contact relay normally closed (max 500VA). 24Vdc power supply. IP20 protection degree with tropicalized board. SMA connector for external antenna (not included).



BANDA DI FREQUENZA 868 MHz
FREQUENCY BAND 868 MHz

FOR EU MARKETS ONLY

CODICE: CODE:	TENSIONE IN INGRESSO: INPUT VOLTAGE:	USCITA DI CONTROLLO: CONTROL OUTPUT:	POTENZA: POWER:	DIMENSIONI LxPxH: DIMENSION LxWxH:
ZQ10-01R0 (RFxLT8)	24 Vdc	max 8 driver DALI/1-10V	4W	36 x 90 x 32 mm (DIN rail)
ZQ10-02R0 (RFxLT16)	24 Vdc	max 16 driver DALI/1-10V	4W	36 x 90 x 32 mm (DIN rail)
ZQ10-03R0 (RFxLT32)	24 Vdc	max 32 driver DALI/1-10V	4W	36 x 90 x 32 mm (DIN rail)

OPZIONALE OPTIONAL

CODICE: CODE:	TENSIONE IN INGRESSO: INPUT VOLTAGE:	GUADAGNO: GAIN:	DIMENSIONI LxPxH: DIMENSION LxWxH:
-------------------------	--	---------------------------	--

GATEWAY PORTATILE BLUETOOTH LE / PORTABLE BLUETOOTH LE GATEWAY

ZQ08-01R0
(RFxGATE-LT)



Batteria 9 Vdc (inclusa)
9 Vdc battery (included)

-

120 x 76 x 28 mm



Scheda tecnica
Datasheet

ANTENNA

ZQ06-01R0
(ZQ-ANT-1)



-

0 dBi

Ø30 x 60 mm



Scheda tecnica
Datasheet

ANTENNA

ZQ06-03R0
(ZQ-ANT-3)



-

4 dBi

77,3 x 66,5 mm



Scheda tecnica
Datasheet

UNIVERSAL LIGHTING CONTROLLER WIRELESS 868 MHz / 2.4GHz

ZQxULC-LT



Scheda tecnica
Datasheet



ZQxULC gestisce tutti i tipi di apparecchi di illuminazione, controller e sensori grazie ai suoi I/O ed alle interfacce cablate (DALI, RS485) e wireless (868MHz, 2.4GHz). ZQxULC può agire come gateway Ethernet utilizzando il protocollo Modbus TCP.

ZQxULC manages all types of lighting luminaires, controllers and sensors thanks to its I/O and to wired (DALI, RS485) and wireless (868MHz, 2.4GHz) interfaces. ZQxULC can acts as a Ethernet gateway using Modbus TCP protocol.







BANDA DI FREQUENZA 868 MHz / 2.4 GHz
FREQUENCY BAND 868 MHz / 2.4 GHz

FOR EU MARKETS ONLY

CODICE: CODE:	TENSIONE IN INGRESSO: INPUT VOLTAGE:	USCITA DI CONTROLLO: CONTROL OUTPUT:	CONTROLLO IN INGRESSO: CONTROL INPUT:	DIMENSIONI LxPxH: DIMENSION LxWxH:
ZQ15-01R0 (ZQxULC-LT)	24 Vdc	max 64 driver DALI	4 ingressi digitali	88 x 90 x 32 mm (DIN rail)

OPZIONALE OPTIONAL

CODICE: CODE:	BANDA DI FREQUENZA: FREQUENCY BAND:	GUADAGNO: GAIN:	DIMENSIONI LxPxH: DIMENSION LxWxH:	
ANTENNA ZQ06-02R0 (ZQ-ANT-2)	 868 MHz	2.1 dBi	Ø30 x 200 mm	 Scheda tecnica Datasheet
ANTENNA ZQ06-04R0 (ZQ-ANT-4)	 2.4 GHz	>2.5 dBi	Ø30 x 60 mm	 Scheda tecnica Datasheet

2.4 GHz BLE/ZIGBEE TO DALI WIRELESS LIGHTING CONTROLLER WITH I/O CONNECTOR Z-NODE



Controller wireless Mesh Network 2.4 GHz Bluetooth LE/Zigbee compatibile.
Gestisce in regolazione fino a 4 o 32 driver standard DALI. Antenna integrata.
Alimentazione autosensing da 230Vac oppure da linea DALI secondo le specifiche DALI2 D4i.
Connettore I/O per sensore esterno.

Bluetooth LE/Zigbee compatible Mesh Network 2.4 GHz wireless controller. It manages up to 4 or 32 standard DALI drivers in regulation. Integrated antenna.
Autosensing power supply between 230Vac or DALI bus according to D4i DALI2 specification. I/O connector for external sensor.



BANDA DI FREQUENZA 2.4 GHz
FREQUENCY BAND 2.4 GHz

FOR EU MARKETS ONLY

CODICE: CODE:	TENSIONE IN INGRESSO: INPUT VOLTAGE:	USCITA DI CONTROLLO: CONTROL OUTPUT:	DIMENSIONI LxPxH: DIMENSION LxWxH:
ZQ11-02R0 (Z-NODE v2)	Autosensing 120-230Vac 50/60Hz e D4i	max 4 driver DALI-2 (D4i)	122 x 33,3 x 19,3 mm
ZQ11-03R0 (Z-NODE-32)	Autosensing 120-230Vac 50/60Hz e D4i	max 32 driver DALI-2	122 x 33,3 x 19,3 mm

2.4 GHZ BLE/ZIGBEE DIGITAL INPUT INTERFACE

Z-PB4 v1

ZQ



Scheda tecnica
Datasheet



Interfaccia pulsanti wireless Mesh Network 2.4 GHz Bluetooth LE/Zigbee compatibile.
Gestisce 4 ingressi digitali configurabili per pulsanti ed interruttori standard. Antenna integrata.
Alimentazione 230Vac.

Bluetooth LE/Zigbee compatible Mesh Network 2.4 GHz wireless push-button interface.
It manages 4 configurable digital inputs for standard pushbuttons and switches.
Integrated antenna. 230Vac power supply.



BANDA DI FREQUENZA 2.4 GHz
FREQUENCY BAND 2.4 GHz

FOR EU MARKETS ONLY

CODICE:
CODE:

ZQ20-08R0
(Z-PB4 v1)

TENSIONE IN INGRESSO:
INPUT VOLTAGE:

100-240Vac 50/60Hz

CONTROLLO IN INGRESSO:
CONTROL INPUT:

4 ingressi digitali

DIMENSIONI LxPxH:
DIMENSION LxWxH:

41 x 47 x 20 mm

2.4 GHz ZIGBEE/BLUETOOTH ETHERNET GATEWAY

Z-GWETH v1

X-CONNECT



Scheda tecnica
Datasheet

Gateway Ethernet per nodi wireless 2.4 GHz Zigbee/Bluetooth. RTC ed antenna integrata. Alimentazione PoE oppure 12Vdc. La versione X-CONNECT permette di gestire nodi wireless Signify Master Connect.

Ethernet gateway for 2.4 GHz Zigbee/Bluetooth wireless nodes. Integrated RTC and antenna. PoE or 12Vdc power supply. The X-CONNECT version allows to manage Signify Master Connect wireless nodes.



BANDA DI FREQUENZA 2.4 GHz
FREQUENCY BAND 2.4 GHz

FOR EU MARKETS ONLY

CODICE: CODE:	TENSIONE IN INGRESSO: INPUT VOLTAGE:	POTENZA: POWER:	DIMENSIONI LxPxH: DIMENSION LxWxH:
ZQ24-01R0 (Z-GWETH v1)	12 Vdc / PoE	8W	124 x 100 x 35 mm
ZQ24-02R0 (X-CONNECT)	12 Vdc / PoE	8W	124 x 100 x 35 mm

MULTIPURPOSE LIGHTING SERVER ZQxSERVER-LTE



Scheda tecnica
Datasheet



Unità di controllo per la gestione dei sistemi ZETAQLAB. Interfacce Ethernet, RS232, RS485, USB, I/O. Orologio astronomico (RTC). Modem LTE integrato (SIM esclusa). Web server integrato ed applicazione xSETUP per la configurazione del sistema. Alimentazione 10-30Vdc. Scatola DIN 6 moduli. IP20.

Control unit for the management of ZETAQLAB systems. Ethernet, RS232, RS485, USB, I/O interfaces. Astronomical Clock (RTC). Integrated LTE modem (SIM excluded). Integrated web server and xSETUP application for system configuration. Power supply 10-30Vdc. 6-module DIN box. IP20.

SISTEMA OPERATIVO LINUX

LINUX OPERATING SYSTEM

FOR EU MARKETS ONLY

CODICE: CODE:	TENSIONE IN INGRESSO: INPUT VOLTAGE:	LTE MODEM (OPZIONALE): LTE MODEM (OPTION)	POTENZA: POWER:	DIMENSIONI LxPxH: DIMENSION LxWxH:
ZQ05-05R0 (ZQxSERVER-LTE)	10..30 Vdc	Modem LTE con connettore per antenna esterna SMA (ME 3630 E1C - Europa) LTE modem with external SMA antenna connector (ME 3630 E1C - Europe)	max 25W	91 x 106 x 61 mm (DIN rail)

OPZIONALE OPTIONAL

CODICE: CODE:	BANDA DI FREQUENZA: FREQUENCY BAND:	GUADAGNO: GAIN:	DIMENSIONI LxPxH: DIMENSION LxWxH:
ANTENNA ZQ06-05R0 (ZQ-ANT-5) 	698-960 MHz 1710-2170 MHz 2400-2690 MHz 3300-3800 MHz	2.1 dBi 3.5 dBi 4.5 dBi 4.5 dBi	Ø16 x 82 mm



Scheda tecnica
Datasheet

DALI-2 MULTI-MASTER SERVER D-SERVER

ZQ



Scheda tecnica
Datasheet



Server Ethernet DALI-2 Multi-Master per la configurazione, la gestione ed il monitoraggio di massimo 64 dispositivi di uscita (driver LED, uscite relè) e massimo 64 dispositivi di ingresso (sensori, interfacce pulsanti). Web server ed orologio astronomico integrati. Alimentazione 230Vac. Certificato DALI-2.

DALI-2 Multi-Master Ethernet server for configuration, management and monitoring of up to 64 output devices (LED drivers, relay outputs) and up to 64 input devices (sensors, pushbutton interfaces). Integrated web server and astronomical clock. 230Vac power supply. DALI-2 certificated.

FOR EU MARKETS ONLY

CODICE: CODE: ZQ17-00R0 (D-SERVER)	TENSIONE IN INGRESSO: INPUT VOLTAGE: 100-240 Vac 50/60 Hz	USCITA DI CONTROLLO: CONTROL OUTPUT: max 64+64 dispositivi DALI-2	POTENZA: POWER: 7.5W	DIMENSIONI LxPxH: DIMENSION LxWxH: 71 x 90 x 58 mm (DIN rail)
---	--	--	-----------------------------------	--

DALI-2 MULTI-MASTER PUSH BUTTON COUPLER D-PB4

ZQ



Scheda tecnica
Datasheet



Interfaccia DALI-2 Multi-Master per la gestione di 4 pulsanti Normalmente Aperti (contatti puliti). Alimentazione da bus DALI. Occupa un indirizzo DALI. Certificato DALI-2.

DALI-2 Multi-Master interface for coupling 4 Normally Open buttons (dry contacts). Power supply from DALI bus. One DALI address required. DALI-2 certificated.

FOR EU MARKETS ONLY

CODICE:
CODE:

ZQ17-01R0
(D-PB4)

TENSIONE IN INGRESSO:
INPUT VOLTAGE:

Bus DALI 12-22.5 Vdc

CONTROLLO IN INGRESSO:
CONTROL INPUT:

4 ingressi digitali

DIMENSIONI LxPxH:
DIMENSION LxWxH:

39 x 39 x 13 mm

DALI-2 MULTI-MASTER 2-CHANNEL RELAY MODULE D-RL2

ZQ



Scheda tecnica
Datasheet



Modulo relè a 2 canali DALI-2 Multi-Master per la gestione di un carico massimo da 2x12A. Alimentazione da bus DALI. Occupa due indirizzi DALI. Certificato DALI-2.

DALI-2 Multi-Master 2-channel relay module for managing a maximum load of 2x12A. Power supply from DALI bus. It occupies two DALI addresses. DALI-2 certificated.

FOR EU MARKETS ONLY

CODICE:
CODE:

ZQ17-02R0
(D-RL2)

TENSIONE IN INGRESSO:
INPUT VOLTAGE:

Bus DALI 12-22.5 Vdc

USCITA DI CONTROLLO:
CONTROL OUTPUT:

2 uscite relay

DIMENSIONI LxPxH:
DIMENSION LxWxH:

36 x 90 x 58 mm

TOUCHPANEL WITH ETHERNET, WIFI AND BLUETOOTH INTERFACE ZQ-TOUCH-10PDVX

ZQ



Scheda tecnica
Datasheet



Touchpanel 10" con interfaccia Ethernet, WiFi e Bluetooth. Risoluzione 1280x800 pixel. Alimentazione 12Vdc e PoE+. Attacco VESA e staffa per il montaggio a muro (opzionale).

10" Touchpanel with Ethernet, WiFi and Bluetooth interface. Resolution 1280x800 pixels. 12Vdc and PoE + power supply. VESA socket and wall mounting bracket (optional).

SISTEMA OPERATIVO ANDROID 8
ANDROID 8 OPERATING SYSTEM

FOR EU MARKETS ONLY

CODICE: CODE:	TENSIONE IN INGRESSO: INPUT VOLTAGE:	SCHERMO SCREEN:	POTENZA: POWER:	DIMENSIONI LxPxH: DIMENSION LxWxH:
ZQ13-01R0 (ZQ-TOUCH-10PDVX)	12 Vdc 2A, PoE+	Touch 10.1" Risoluzione / Definition 1280x800 pixel Luminosità / Brightness 500 cd/m2	20W	256 x 181 x 27 mm

OPZIONALE
OPTIONAL

CODICE: CODE:	COLORE: COLOUR:	DIMENSIONI LxPxH: DIMENSION LxWxH:
STAFFE DI FISSAGGIO / FIXING BRACKETS ZQ13-02R0 (ZQ-STAFF-PDVX)	NERO / BLACK	100 x 75 x 11 mm (VESA 75/100)



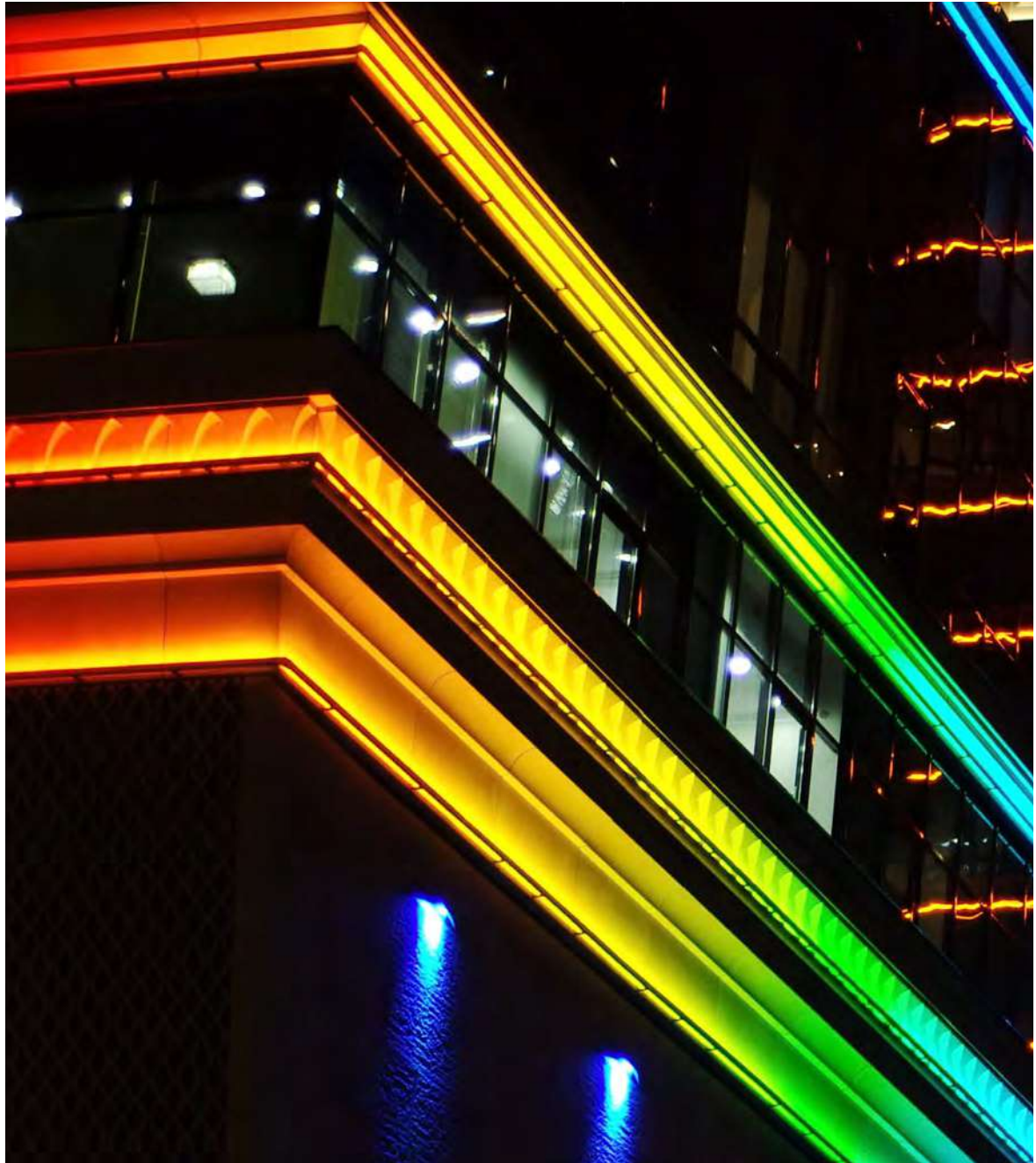

Sensori e automazione del sistema

Sensors and system automation

Gli apparecchi luminosi possono essere accesi/spenti e regolati in base alla rilevazione del movimento degli utenti ed al contributo di luce naturale per mantenere un livello luminoso costante sulla superficie di riferimento.

Per ottenere questa funzionalità si utilizzano multi sensori in grado di:

- Rilevare il movimento MD - Motion Detection
- Regolare l'intensità luminosa in funzione del contributo di luce naturale - DLR Day Light Regulation

Luminaire can be on/off and dimmed according to the movement detection of the users and daylight contribution in order to keep a constant light level on a reference surface.

To obtain this function we use multi sensors which are able to:

- Detect motion (MD - Motion Detection)
- Adjust light intensity according to daylight contribution (DLR - Day Light Regulation)

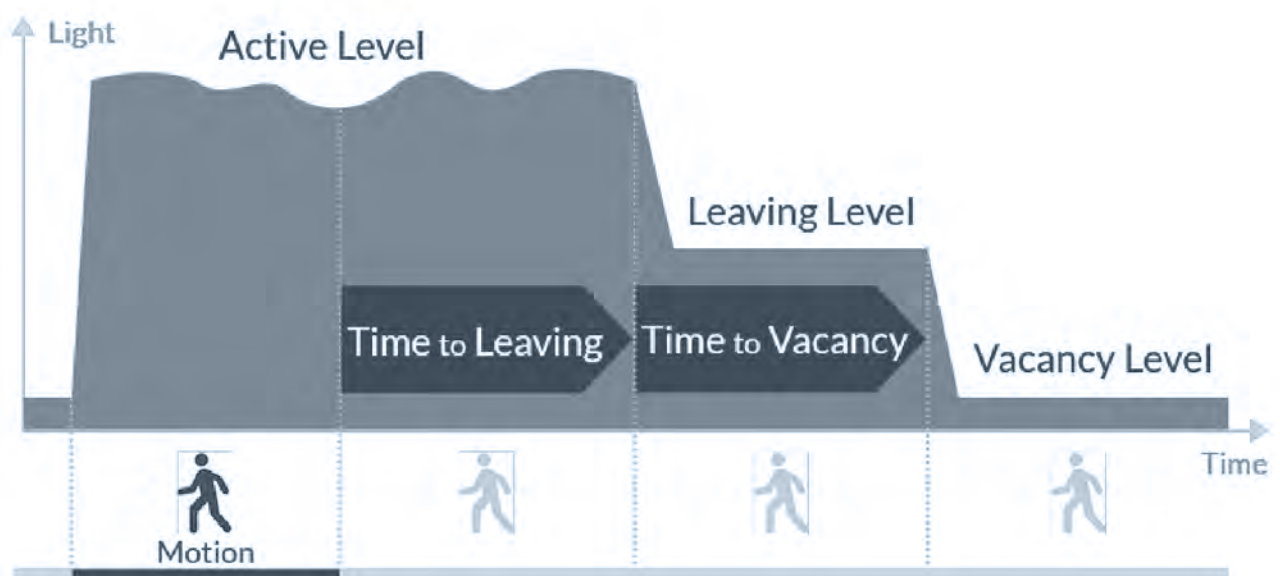

I sensori ZETAQLAB utilizzati devono essere selezionati in base all'applicazione. In particolare è necessario verificare la loro altezza di installazione che ne definisce l'area di rilevazione del movimento come riportato nei vari datasheet.

La funzionalità DLR è sconsigliata ad altezze superiori a 10 - 12 m in quanto la quantità di luce che «arriva» al sensore è scarsamente proporzionale a quella riflessa dalla superficie sottostante e molto più influenzata da quella diffusa.

Altezza di installazione (H)	Diametro dell'area di rilevamento(D)		
	Altezze basse LB	Altezze medie MB	Altezze elevate HB
2,7 m	10,4 m	7,4 m	3,7 m
5 m	19,2 m	13,8 m	6,9 m
8 m	-	22,0 m	11,0 m
10 m	-	22,5 m	13,7 m
12 m	-	-	16,5 m
17 m	-	-	23,4 m

The ZETAQLAB sensors used have to be selected according to the application. In particular it is necessary to verify their installation height which defines the movement detection area, as showed in the datasheets.

DLR functionality is not recommended at heights greater than 10 - 12 meters, as the quantity of light that «reaches» the sensor is scarcely proportional to that reflected by the underlying surface and much more influenced by the diffused one.

FOV - Field of View: Angolo di apertura del sensore

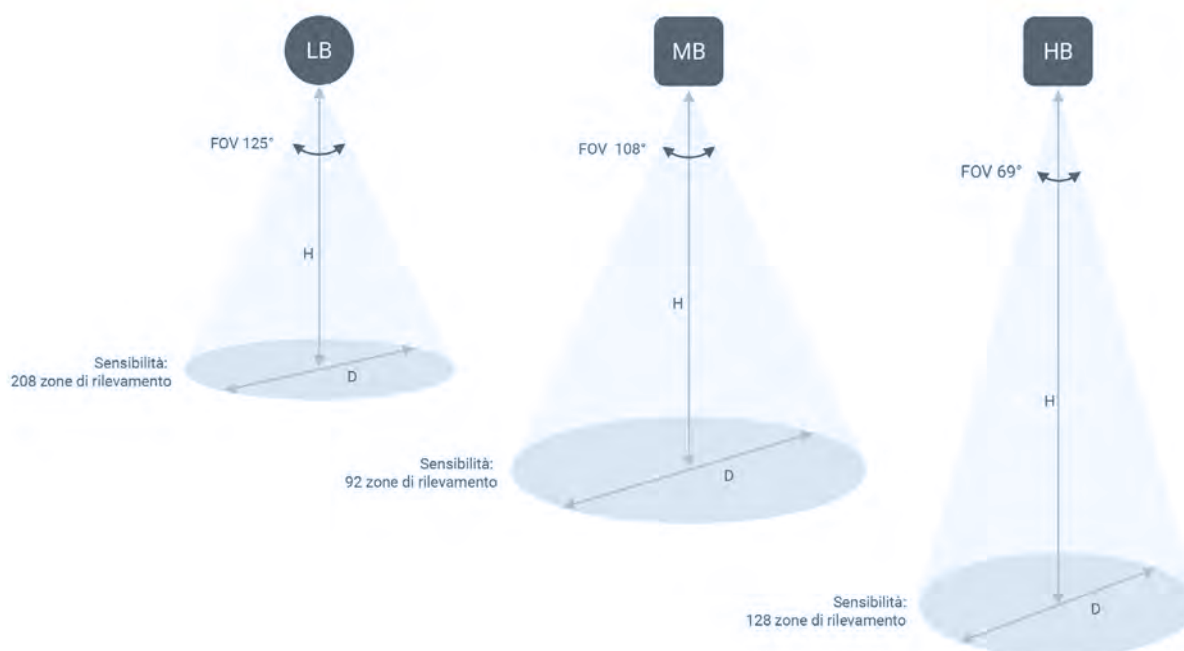

2.4 GHZ WIRELESS INTEGRATED LIGHTING CONTROLLER AND SENSOR Z-SENSOR



Multisensore wireless Mesh Network 2.4 GHz compatibile BLE/Zigbee. Gestisce in regolazione e potenza fino a 32 driver standard DALI o 1/10V, uscita relè normalmente chiusa (NC) da 500VA. Sensore di luminosità e movimento Mid Bay (Hmax 10m - FOV 108°) ed High Bay (Hmax 17m - FOV 69°). Antenna integrata. Alimentazione autosensing da 230Vac oppure da linea DALI secondo le specifiche DALI-2 D4i. IP54.

SENSORE DI LUMINOSITÀ: Range 5-500 lux (diretti)

2.4 GHz Mesh Network wireless multisensor BLE/Zigbee compatible. It manages in regulation and power up to 32 standard DALI or 1/10V drivers, 500VA normally closed (NC) relay output. Mid Bay (Hmax 10m - FOV 108°) and High Bay (Hmax 17m - FOV 69°) light and motion sensor. Integrated antenna. Autosensing power supply between 230Vac or DALI bus according to D4i DALI2 specification. IP54.



LIGHT SENSOR: Range 5-500 lux (directs)



BANDA DI FREQUENZA 2.4 GHz
FREQUENCY BAND 2.4 GHz

FOR EU MARKETS ONLY

CODICE: CODE:	TENSIONE IN INGRESSO: INPUT VOLTAGE:	USCITA DI CONTROLLO: CONTROL OUTPUT:	SENSORE DI MOVIMENTO: MOTION SENSOR:	POTENZA: POWER:	DIMENSIONI LxPxH: DIMENSION LxWxH:
ZQ16-00R0 (Z-SENSOR-MB)	Autosensing 85-305 Vac 47-63 Hz Bus DALI-2 (D4i)	max 32 driver DALI2/1-10V	Hmax 10m - FOV 108°	2W	109 x 109 x 50 mm
ZQ16-01R0 (Z-SENSOR-HB)	Autosensing 85-305 Vac 47-63 Hz Bus DALI-2 (D4i)	max 32 driver DALI2/1-10V	Hmax 17m - FOV 69°	2W	109 x 109 x 50 mm

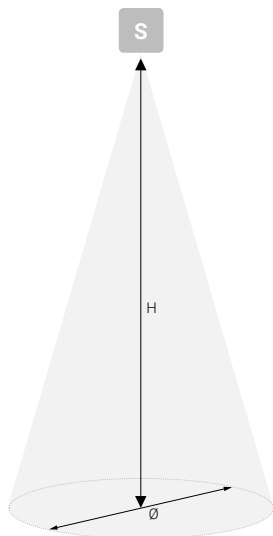

Area di rilevamento <i>Detection Area</i>		
Altezza di installazione <i>Installation height</i>	Z-SENSOR-MB (Mid Bay)	Z-SENSOR-HB (High Bay)
H	Ø	Ø
3 m	8,3 m	4,1 m
4 m	11,0 m	5,5 m
5 m	13,8 m	6,9 m
6 m	16,5 m	8,2 m
7 m	19,3 m	9,6 m
8 m	22,0 m	11,0 m
9 m	24,8 m	12,4 m
10 m	27,5 m	13,7 m
11 m	-	15,1 m
12 m	-	16,5 m
13 m	-	17,9 m
14 m	-	19,2 m
15 m	-	20,6 m
16 m	-	22,0 m
17 m	-	23,4 m

WIRELESS DALI MULTISENSOR DALI-SENSE v3



Scheda tecnica
Datasheet



Multisensore DALI wireless 2.4 GHz compatibile Zigbee 3.0 e Bluetooth LE. Gestisce fino a 32 driver standard DALI in modalità "broadcast" oppure indirizzata. 1 ingresso digitale. Sensore di luminosità e movimento (Hmax 5m - FOV 106°). Antenna integrata. Alimentazione 230Vac. IP20.

SENSORE DI LUMINOSITÀ: Range 5-500 lux (diretti)

2.4 GHz Mesh Network wireless DALI multisensor Zigbee 3.0 and Bluetooth LE compatible. It manages up to 32 standard DALI drivers in "broadcast" or addressed mode. 1 digital input. Light and movement sensor (Hmax 5m - FOV 106°). Integrated antenna. Power supply 230Vac. IP20.

LIGHT SENSOR: Range 5-500 lux (directs)



BANDA DI FREQUENZA 2.4 GHz
FREQUENCY BAND 2.4 GHz

FOR EU MARKETS ONLY

CODICE: CODE:	TENSIONE IN INGRESSO: INPUT VOLTAGE:	USCITA DI CONTROLLO: CONTROL OUTPUT:	SENSORE DI MOVIMENTO: MOTION SENSOR:	POTENZA: POWER:	DIMENSIONI LxPxH: DIMENSION LxWxH:
ZQ04-04R0 (DALI-SENSE v3)	100-240 Vac 50-60 Hz	max 32 driver DALI	Hmax 5m - FOV 106°	2W	Ø82 x 30 mm

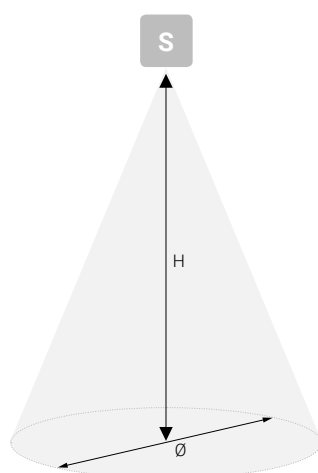

Area di rilevamento Detection Area	
Altezza di installazione Installation height	DALI-SENSE v3 (Office) Ø
H	Ø
2,7 m	7,2 m
3 m	8,0 m
3,5 m	9,3x m
4 m	10,6 m
4,5 m	11,9 m
5 m	13,3 m

CONDIZIONI GENERALI DI VENDITA

1. Condizioni generali di vendita

Le presenti condizioni generali di vendita ("Condizioni Generali"), salvo eventuali deroghe specificamente concordate per iscritto, disciplinano i rapporti di fornitura tra ELCOM S.r.l. ("ELCOM") ed il cliente ("Cliente").

Salvo diversa pattuizione scritta tra le parti, le presenti condizioni generali di vendita sostituiscono e prevalgono su qualsivoglia intesa, proposta o accordo, sia scritto sia orale, intercorso tra le parti, ivi inclusi, a titolo meramente esemplificativo, eventuali termini e condizioni del cliente.

2. Conclusione del contratto

L'ordine di acquisto inoltrato dal Cliente a ELCOM ha natura di semplice proposta contrattuale vincolante per il solo Cliente ("Ordine").

Salvo diverso accordo, l'accettazione da parte del Cliente dei preventivi rilasciati da ELCOM comporta l'emissione di un Ordine avente la medesima natura sopra prevista. L'Ordine emesso sulla base di un preventivo ("Preventivo") vale quale accettazione integrale del preventivo in tutti i suoi termini e condizioni ed ogni variazione a quanto oggetto del preventivo, per essere valida, dovrà essere espressamente indicata nell'Ordine.

La sottoscrizione dell'Ordine da parte del Cliente costituisce espressa, integrale ed incondizionata adesione alle presenti condizioni generali di vendita, fatti salvi eventuali accordi diversi conclusi fra ELCOM ed il Cliente in forma scritta. L'Ordine è vincolante per ELCOM solo dopo che quest'ultima ne abbia accettato il contenuto a mezzo di emissione e trasmissione al Cliente di apposita conferma d'ordine ("Conferma d'Ordine").

3. Oggetto della vendita

Oggetto della vendita sono esclusivamente i beni descritti nella conferma d'ordine, individuati e selezionati dal Cliente tra quelli presentati nel sito web di ELCOM e/o in cataloghi, brochure e documenti illustrativi di quest'ultima ("Prodotto/i").

Le eventuali rappresentazioni visive dei Prodotti, ove presenti e riportate nei documenti sopra elencati, corrispondono normalmente all'immagine fotografica dei Prodotti stessi e hanno valore indicativo, senza alcuna garanzia o impegno, da parte di ELCOM circa l'esatta corrispondenza dell'immagine raffigurata con il Prodotto reale.

ELCOM si riserva il diritto e la facoltà di apportare, in qualunque momento, variazioni tecniche, formali e dimensionali ai propri Prodotti.

4. Prezzo della vendita

Il corrispettivo per la fornitura dei Prodotti descritti nella conferma d'ordine è quello indicato nella relativa fattura(e) inviata(e) al Cliente.

5. Pagamento

Il pagamento del corrispettivo della fornitura deve essere effettuato secondo i termini e le modalità riportati nella relativa fattura (o fatture), da considerarsi essenziali ai sensi e per gli effetti dell'art. 1457 Codice Civile. In caso di ritardo nei pagamenti da parte del Cliente, quest'ultimo verrà ritenuto inadempiente e gli verranno applicati gli interessi di cui al D. Lgs. 9.10.2002, n. 231, senza necessità di messa in mora, a decorrere dal giorno della scadenza al saldo effettivo, fatto salvo il diritto di ELCOM di agire per il recupero delle spese sostenute e dei danni subiti.

6. Modifica, cancellazione e supplemento dell'Ordine

ELCOM si riserva il diritto di valutare ogni richiesta di modifica e/o di cancellazione e/o di supplemento dell'Ordine ricevuti dal Cliente. In ogni caso, ove ELCOM ritenesse di accettare tali richieste, il Cliente sarà comunque tenuto a versare a ELCOM gli eventuali costi sostenuti per la modifica, cancellazione e/o supplemento, in particolare qualora sia stata già avviata la produzione dei Prodotti in questione e/o siano stati forniti dei servizi e/o si sia già provveduto alla spedizione dei Prodotti. Modifiche, cancellazioni ed aggiunte di ordini di fornitura devono intendersi, a loro volta, sottoposte alle presenti condizioni generali di vendita.

7. Sospensione dell'Ordine

ELCOM si riserva, in qualsiasi momento, il diritto di sospendere l'esecuzione degli ordini ricevuti qualora dovessero verificarsi variazioni di qualsiasi genere in relazione alla capacità del Cliente ad adempiere alle proprie obbligazioni, ovvero in caso di accertata difficoltà dello stesso a provvedere puntualmente ad effettuare i pagamenti dovuti, anche nei confronti dei terzi.

8. Termini e modalità di consegna dei beni

I termini di consegna dei Prodotti oggetto di vendita indicati nella Conferma d'Ordine hanno valore puramente indicativo e non essenziale, e non impegnano ELCOM, con la conseguenza che quest'ultima non assume alcuna responsabilità in ordine al mancato rispetto degli stessi. La consegna dei Prodotti oggetto di vendita avviene secondo le modalità di spedizione usualmente adottate da parte di ELCOM ed i relativi costi sono totalmente a carico del Cliente, salvo diverso accordo scritto tra le parti.

In caso di mancata presa in consegna dei Prodotti da parte del Cliente e/o di ritardo nella presa in consegna che ecceda i 15 giorni, il contratto di vendita si intenderà risolto di diritto per grave inadempimento del Cliente, ai sensi e per gli effetti di cui all'articolo 1456, Codice Civile. I costi e le spese di ritiro e trasporto dei Prodotti saranno addebitati al Cliente in misura pari all'8% del valore dell'Ordine, quale riportato in fattura.

Resta salvo il diritto di ELCOM al risarcimento del maggior danno subito.

9. Garanzia

ELCOM garantisce la conformità dei Prodotti forniti a quanto espressamente indicato nella Conferma d'Ordine e, in caso di Prodotti oggetto di Preventivo, alla documentazione tecnica eventualmente fornita al Cliente.

ELCOM garantisce altresì che i Prodotti forniti al Cliente sono esenti da vizi e difetti che li rendano idonei all'uso per i quali sono stati fabbricati ed a cui sono normalmente destinati, così come riportato nel catalogo e nelle schede tecniche di ELCOM stessa.

ELCOM non assume alcuna responsabilità sul Prodotto fornito qualora lo stesso, dopo la consegna, venga manipolato e/o trasformato dal Cliente in autonomia e senza alcun intervento da parte di ELCOM stessa. In tale caso, il Cliente perde qualsivoglia diritto di garanzia sul Prodotto o sui Prodotti acquistati.

Fermo restando quanto sopra, in caso di accertati difetti dei Prodotti oggetto di fornitura, ELCOM provvederà, a seconda dei casi ed esclusivamente a favore del Cliente, alla sostituzione dei Prodotti difettosi, subordinatamente al rispetto da parte del Cliente delle previsioni che seguono.

Salvo diverso accordo scritto tra le parti, la richiesta di intervento in garanzia ha una durata limitata a 24 mesi, decorrenti dalla data di consegna del Prodotto ed a condizione che la denuncia sia avvenuta nei termini di seguito indicati. Trascorso tale periodo nessuna pretesa potrà essere avanzata nei confronti di ELCOM.

La denuncia di eventuali vizi o difformità con contestuale richiesta di intervento in garanzia deve essere effettuata entro e non oltre 8 giorni decorrenti dalla data di consegna del bene, mediante lettera raccomandata A/R o a mezzo di posta elettronica certificata indirizzata al Servizio Clienti di ELCOM, allegando la copia della bolla, della fattura, ovvero del documento d'accompagnamento, e indicando dettagliatamente i vizi rilevati.

La validità e l'applicazione della garanzia sono comunque subordinate all'esatto utilizzo dei Prodotti forniti, secondo le specifiche indicate in cataloghi, avvertenze e libretti d'istruzioni messi a disposizione del Cliente.

Senza pregiudizio per quanto precede, ELCOM offre ai propri Clienti la possibilità di usufruire di una garanzia convenzionale, ai termini ed alle condizioni precisati nella successiva sezione "Garanzia Convenzionale – Termini e Condizioni Generali".

10. Reclami

Eventuali reclami aventi ad oggetto la fornitura dei prodotti devono essere effettuati entro e non oltre 30 giorni dal momento in cui gli stessi Prodotti sono stati consegnati al Cliente. Trascorso tale termine, il reclamo non potrà essere più accolto.

I reclami devono essere effettuati mediante lettera raccomandata A/R o a mezzo di posta elettronica certificata, ove del caso anticipata via email, indirizzata al Back office di ELCOM, allegando la copia della bolla, della fattura, ovvero del documento d'accompagnamento, e devono indicare dettagliatamente i motivi del reclamo. Qualora il reclamo risulti infondato, il Cliente sarà tenuto a rimborsare a ELCOM tutte le spese sostenute per l'eventuale attività svolta in relazione all'accertamento dell'assunta difformità.

11. Limitazioni di responsabilità

Il Cliente si impegna ad utilizzare i Prodotti acquistati da ELCOM conformemente alla loro destinazione d'uso ed a rispettare tutte le regole e le procedure di utilizzo indicate nella documentazione tecnica eventualmente fornita da ELCOM.

Fermo restando quanto previsto alle clausole 9 e 10 che precedono, ELCOM non presta alcuna garanzia al Cliente e, in particolare, non garantisce la commerciabilità dei Prodotti acquistati dal Cliente né garantisce che questi ultimi siano idonei ad un determinato uso.

Pertanto, ELCOM non potrà in alcun caso ritenersi responsabile per inadempimenti, danni, diretti e/o indiretti, e perdite subite dal Cliente, inclusi suoi dipendenti, collaboratori e/o aventi causa né per danni provocati al Cliente od a terzi da negligenza, imprudenza od imperizia da parte del Cliente a seguito della consegna dei Prodotti.

Inoltre, in nessun caso ELCOM potrà essere ritenuta responsabile per inadempimenti, danni, diretti e/o indiretti, prodotti in tutto o in parte da cause riconducibili all'utilizzo dei Prodotti oggetto di fornitura, perdite dovute a ritardi di consegna da parte della stessa ELCOM, dei suoi dipendenti e/o suoi agenti, perdite di produzione o mancati profitti del Cliente e/o di terzi in genere.

Per gli anzidetti scopi e senza pregiudizio per l'applicazione di norme inderogabili di legge, il Cliente dichiara ed accetta di garantire, manlevare e tenere indenne ELCOM (incluse società controllanti, controllate e collegate) in relazione a qualsiasi richiesta, costo, domanda giudiziale, procedimento, azione, responsabilità, perdita, spesa, ordinanza, decreto, diritti ed onorari legali, spese di giustizia, inclusi danni di qualsiasi tipo derivanti, connessi o nascenti da qualsiasi attuale o lamentato danno che si assume originante e/o comunque riconducibile ai Prodotti oggetto di fornitura. A questo proposito, il Cliente si impegna a risarcire tutti gli eventuali danni derivanti dalle pretese in questione.

12. Disegni e documentazione tecnica

I disegni e le specifiche tecniche dei Prodotti oggetto dell'Ordine sono di esclusiva proprietà di ELCOM e/o di eventuali soggetti terzi licenziatari e non possono essere riprodotti, copiati o divulgati per nessun motivo.

I disegni e la documentazione tecnica relativi ai Prodotti od alla loro fabbricazione non potranno, senza il consenso scritto di ELCOM o del legittimo proprietario, essere utilizzati per scopi diversi rispetto a quello per il quale sono stati forniti e, in particolare, non potranno essere utilizzati o copiati, riprodotti, trasmessi o comunicati a terzi ovvero essere utilizzati per la fabbricazione, progettazione o qualsiasi altro scopo non espressamente autorizzato.

13. Diritti di proprietà industriale ed intellettuale

I diritti di proprietà industriale e/o intellettuale sui marchi, loghi, brevetti, segni distintivi, registrati e non, riportati sui Prodotti e su tutti i rispettivi materiali illustrativi, manuali, specifiche tecniche e altre informazioni fornite da ELCOM unitamente ai Prodotti medesimi e/o in relazione ad essi, resteranno di esclusiva proprietà di ELCOM e/o dei soggetti titolari dei relativi diritti. Il Cliente sarà tenuto ad indenizzare ELCOM contro qualsiasi danno, pretesa, costo e spesa che ELCOM possa subire e/o sostenere per effetto di qualsivoglia violazione e/o presunta violazione di brevetti, marchi, loghi, copyright, disegni industriali registrati e non, e/o qualsiasi altro diritto di proprietà intellettuale e/o industriale posta in essere dal Cliente.

ELCOM si riserva tutti i diritti di proprietà industriale e di esclusiva per la produzione e distribuzione dei Prodotti oggetto di fornitura.

14. Prodotti personalizzati

Qualora su espressa richiesta del Cliente, ELCOM accetti di personalizzare e, quindi, produca prodotti personalizzati per il Cliente, tale ulteriore attività sarà a totale carico del Cliente stesso, ivi inclusi eventuali costi di design e le altre spese necessarie per l'acquisto di materiale e/o lo sviluppo di componenti speciali, che saranno dettagliati in un Preventivo.

Salvo ove diversamente previsto dalle presenti condizioni generali o concordato espressamente tra ELCOM ed il Cliente, le presenti condizioni generali troveranno applicazione anche alla vendita ed alla fornitura dei prodotti personalizzati.

15. Inadempimento

Salvo quanto altro previsto dalle presenti condizioni generali, il mancato pagamento, in tutto o in parte, del corrispettivo della fornitura, ovvero l'inosservanza da parte del Cliente anche di una sola clausola delle presenti condizioni generali di vendita, autorizza ELCOM a risolvere di diritto e con effetto immediato il contratto e a richiedere al Cliente l'immediato pagamento di tutti gli importi (anche se ciò comporti l'anticipazione dei relativi termini di scadenza), delle spese accessorie e di eventuali spese legali, oltre all'applicazione degli interessi di mora sulle somme ancora dovute (secondo quanto indicato all'articolo 5 che precede) fino all'integrale soddisfo, fermo restando la possibilità da parte di ELCOM di richiedere, in ogni caso, il maggior danno subito.

Eventuali eccezioni e/o pretese avanzate dal Cliente nei confronti di ELCOM, non attribuiscono al Cliente alcun diritto di rifiutare, in tutto o in parte, l'integrale pagamento del corrispettivo della fornitura.

Qualora dovesse verificarsi anche una sola delle ipotesi di risoluzione sopra riportate, ELCOM potrà altresì interrompere il processo di lavorazione dei Prodotti e/ o sospenderne la fornitura, fermo restando il suo diritto di richiedere il pagamento di quanto indicato in precedenza.

16. Forza maggiore

ELCOM non sarà in alcun modo responsabile nei confronti del Cliente per il mancato o ritardato adempimento di una o più delle proprie obbligazioni contrattuali nell'eventualità in cui tale mancato o ritardato adempimento sia dovuto a cause di forza maggiore, intendendosi per tali, a titolo esemplificativo e non esaustivo, sciopero, serrate sindacali, provvedimenti dell'autorità, furti di materie prime o prodotti finiti, guerra o per qualsivoglia altra causa, comprese calamità naturali, quali sisma, alluvione, maremoto, che non possa essere ragionevolmente prevista o per cui non sia ragionevolmente possibile trovare un rimedio e che non possa essere risolta per il tramite dell'ordinaria diligenza.

Fermo restando quanto precede, ELCOM si adopererà con la massima diligenza per limitare gli effetti negativi derivanti dalla sopravvenuta impossibilità della propria prestazione.

17. Legge applicabile e Foro competente

Le presenti condizioni generali sono disciplinate in via esclusiva dalla legge italiana, con esclusione delle disposizioni di cui alla Convenzione di Vienna sul commercio internazionale. Per qualsiasi controversia relativa o comunque collegata ai contratti cui si applicano le presenti condizioni generali di vendita, ivi incluse quelle inerenti la relativa interpretazione, esecuzione e cessazione, è competente, in via esclusiva, il Foro di Brescia.

18. Immagini prodotto

L'immagine del prodotto è puramente indicativa e potrebbe non rispecchiare appieno le caratteristiche estetiche dell'oggetto che verrà spedito.

GENERAL CONDITIONS OF SALE

1. General conditions of sale

These general terms and conditions of sale ("General Terms and Conditions"), unless otherwise specifically agreed in writing, govern the supply relationship between ELCOM S.r.l. ("ELCOM") and the customer ("Customer"). Unless otherwise agreed in writing between the parties, these General Terms and Conditions of Sale shall supersede and override any agreement, proposal or agreement, whether written or oral, between the parties, including but not limited to: any terms and conditions of the customer.

2. Conclusion of the contract

The purchase order submitted by the Customer to ELCOM is a simple contractual proposal binding only for the Customer ("Order"). Unless otherwise agreed, acceptance by the Customer of the quotations issued by ELCOM entails the issuance of an Order of the same nature as provided above. The Order issued on the basis of a quote ("Estimate") is valid as full acceptance of the estimate in all its terms and conditions and any change to the subject of the estimate, to be valid, must be expressly indicated in the Order. The Customer's signature of the Order constitutes express, complete and unconditional adherence to these General Terms and Conditions of Sale, without prejudice to any other agreements concluded between ELCOM and the Customer in writing. The Order is binding on ELCOM only after ELCOM has accepted its contents by issuing and sending the Customer an order confirmation ("Order Confirmation").

3. Object of sale

The object of the sale is exclusively the goods described in the order confirmation, identified and selected by the Customer among those presented on the ELCOM website and/or in catalogues, brochures and illustrative documents of the latter ("Product/s"). Any visual representations of the Products, where present and reported in the documents listed above, normally correspond to the photographic image of the Products themselves and have indicative value, without any guarantee or commitment, by ELCOM about the exact correspondence of the image depicted with the real Product. ELCOM reserves the right and the right to make technical, formal and dimensional changes to its Products at any time.

4. Price of sale

The payment for the supply of the Products described in the order confirmation is the one indicated in the relevant invoice(s) sent(s) to the Customer.

5. Payment

The payment of the consideration of the supply must be made according to the terms and methods indicated in the relevant invoice (or invoices), to be considered essential pursuant to and for the purposes of art. 1457 Civil Code. In case of delay in payments by the Customer, the latter will be deemed to be in default and will be charged the interest referred to in D. Lgs. 9.10.2002, n. 231, without the need for formal notice, from the day of expiry to the actual balance, without prejudice to the right of ELCOM to take action for the recovery of costs incurred and damages suffered.

6. Modification, cancellation and supplement of the Order

ELCOM reserves the right to evaluate any request for modification and/or cancellation and/or supplement of the Order received by the Customer. In any case, if ELCOM considers that it accepts such requests, the Customer will still be required to pay ELCOM any costs incurred for the modification, cancellation and/or supplement, in particular if the production of the Products in question has already started and/or services have been provided and/or the Products have already been dispatched. Changes, cancellations and additions of supply orders are, in turn, subject to these general conditions of sale.

7. Suspension of the Order

ELCOM reserves the right, at any time, to suspend the execution of orders received if there are any changes of any kind in relation to the Customer's ability to fulfil its obligations, or in the event of its difficulties in making timely payments, including to third parties.

8. Terms and conditions of delivery of goods

The terms of delivery of the Products for sale indicated in the Order Confirmation have a purely indicative and non-essential value, and do not bind ELCOM, with the consequence that the latter assumes no responsibility for failure to comply with them. The delivery of the Products for sale takes place in accordance with the shipping methods usually adopted by ELCOM and the costs are fully borne by the Customer, unless otherwise agreed in writing between the parties.

In the event of failure to take delivery of the Products by the Customer and/or delay in taking over that exceeds 15 days, the contract of sale will be terminated by right for serious breach of the Customer, pursuant to and for the purposes of Article 1456, Codice Civile. The costs and the costs of collection and transport of the Products will be charged to the Customer equal to 8% of the value of the Order, as shown in the invoice.

This is without prejudice to ELCOM's right to compensation for the greatest damage suffered.

9. Guarantee

ELCOM guarantees that the Products supplied comply with the Order Confirmation and, in the case of Products subject to a Quote, with the technical documentation provided to the Customer.

ELCOM also guarantees that the Products supplied to the Customer are free from defects and defects that make them unsuitable for the use for which they were manufactured and for which they are normally intended, as reported in the catalog and in the data sheets of ELCOM itself.

ELCOM assumes no responsibility for the Product supplied if it is handled and/or transformed by the Customer after delivery, independently and without any intervention by ELCOM itself. In this case, the Customer loses any warranty rights on the Product or Products purchased. Without prejudice to the foregoing, in the event of defects in the Products supplied, ELCOM will, as appropriate and exclusively in favour of the Customer, replace the defective Products, subject to the Customer's compliance with the following provisions.

Unless otherwise agreed in writing by the parties, the warranty claim shall be limited to 24 months, starting from the date of delivery of the Product and provided that the complaint has been made within the terms indicated below. After this period, no claims may be made against ELCOM.

The complaint of any defects or discrepancies with simultaneous request for intervention in warranty must be made no later than 8 days from the date of delivery of the goods, by registered letter A/R or by certified e-mail addressed to ELCOM Customer Service, enclosing a copy of the bill, invoice or accompanying document, and detailing the defects detected.

The validity and application of the warranty are however subject to the exact use of the Products provided, according to the specifications indicated in catalogues, warnings and instruction booklets made available to the Customer.

Without prejudice to the foregoing, ELCOM offers its Customers the possibility to take advantage of a conventional guarantee, subject to the terms and conditions specified in the following section "Conventional Warranty - General Terms and Conditions".

10. Complaints

Any complaints concerning the supply of the products must be made no later than 30 days from the moment the same Products were delivered to the Customer. After this period, the complaint can no longer be granted. Complaints must be made by registered letter A/R or by certified e-mail, if necessary in advance by email, addressed to the ELCOM Back Office, attaching a copy of the form, invoice or accompanying document, and must state in detail the reasons for the complaint. If the complaint is found to be unfounded, the Customer will be required to reimburse ELCOM for all costs incurred for any activity carried out in connection with the finding of the non-conformity.

11. Limitations of liability

The Customer undertakes to use the Products purchased by ELCOM in accordance with their intended use and to respect all the rules and procedures of use indicated in the technical documentation provided by ELCOM. Notwithstanding the provisions of clauses 9 and 10 above, ELCOM makes no warranty to the Customer and, in particular, does not guarantee the marketability of the Products purchased by the Customer or guarantee that the latter are suitable for a certain use. Therefore, ELCOM shall in no case be liable for any default, direct and/or indirect damage or loss suffered by the Customer, including its employees, collaborators and/or claimants, or for damage caused to the Customer or to third parties by negligence, imprudence or inexperience on the part of the Customer following the delivery of the products. In addition, in no event shall ELCOM be liable for any default, damage, direct and/or indirect, produced in whole or in part due to the use of the Products supplied, losses due to delays in delivery by ELCOM itself, its employees and/or agents, production losses or lost profits of the Customer and/or third parties in general. For the aforementioned purposes and without prejudice to the application of mandatory legal provisions, the Customer declares and agrees to guarantee, indemnify and hold ELCOM (including parent companies, subsidiaries and associates) harmless in relation to any request, cost, claim, proceedings, action, liability, loss, expense, order, decree, legal fees and charges, costs of justice, including damages of any kind arising, connected or arising from any current or alleged damage that is assumed originating and/or in any case attributable to the products supplied. In this regard, the Customer undertakes to compensate for any damage resulting from the claims in question.

12. Drawings and technical documentation

The drawings and technical specifications of the Products subject to the Order are the exclusive property of ELCOM and/or any third party licensee and may not be reproduced, copied or disclosed for any reason. Drawings and technical documentation relating to the Products or their manufacture may not, without the written consent of ELCOM or the rightful owner, be used for purposes other than those for which they were supplied and, in particular, may not be used or copied, reproduced, transmitted or communicated to third parties or be used for manufacturing, design or any other purpose not expressly authorized.

13. Industrial and intellectual property rights

The industrial and/or intellectual property rights on trademarks, logos, patents, distinctive signs, registered and unregistered, shown on the Products and on all the respective illustrative materials, manuals, technical specifications and other information provided by ELCOM together with the Products themselves and/or in relation to them, will remain the exclusive property of ELCOM and/or the subjects who hold the relevant rights. The Customer shall be obliged to indemnify ELCOM against any damages, claims, costs and expenses that ELCOM may incur and/or incur as a result of any infringement and/or alleged infringement of patents, trademarks, logos, copyrights, registered and unregistered industrial designs, and/or any other intellectual and/or industrial property rights put in place by the Customer. ELCOM reserves all industrial property rights and exclusive rights for the production and distribution of the Products supplied.

14. Customized Products

If, at the express request of the Customer, ELCOM agrees to customize and, therefore, produce customized products for the Customer, this additional activity will be fully borne by the Customer, including any design costs and other expenses necessary for the purchase of material and/or the development of special components, which will be detailed in a Quote. Unless otherwise provided in these general terms and conditions or expressly agreed between ELCOM and the Customer, these general terms and conditions shall also apply to the sale and supply of customized products.

15. Failure to fulfil obligations

Except as otherwise provided in these general conditions, the non-payment, in whole or in part, of the consideration of the supply, or the non-compliance by the Customer even of a single clause of these general conditions of sale, authorises ELCOM to terminate the contract by right and with immediate effect and to require the Customer to immediately pay all amounts (even if this entails the anticipation of the relevant deadlines), incidental costs and any legal fees, in addition to the application of default interest on sums still due (as indicated in Article 5 above) to the full satisfaction, without prejudice to the possibility for ELCOM to claim, in any case, the greatest damage suffered. Any exceptions and/or claims made by the Customer against ELCOM, do not give the Customer any right to refuse, in whole or in part, the full payment of the delivery fee. If only one of the above mentioned resolution scenarios should occur, ELCOM may also interrupt the production process of the Products and/ or suspend their supply, without prejudice to its right to request payment of the above mentioned.

16. Force majeure

ELCOM shall in no way be liable to the Customer for any failure or delay to fulfil one or more of its contractual obligations in the event that such failure or delay is due to reasons of force majeure, by way of example and not exhaustive, strike, union lockouts, authority measures, theft of raw materials or finished products, war or any other cause, including natural disasters, such as earthquake, flood, tsunami, which cannot reasonably be foreseen or for which a remedy cannot reasonably be found and which cannot be resolved by ordinary diligence. Notwithstanding the foregoing, ELCOM will do its utmost to limit the adverse effects resulting from the impossibility of its performance.

17. Applicable law and jurisdiction

These general conditions are governed exclusively by Italian law, with the exclusion of the provisions of the Vienna Convention on International Trade. The Court of Brescia shall have exclusive jurisdiction over any dispute relating to or in any way connected with the contracts to which these general conditions of sale apply, including those relating to their interpretation, execution and termination.

18. Product images

The image of the product is purely indicative and may not fully reflect the aesthetic characteristics of the item that will be shipped.

member of
STARLIGHT
www.starlight.lighting

ELCOM SRL - MEMBER OF STARLIGHT GROUP

Via Ugo la Malfa, 5 - 25030
Castel Mella (BS) - Italia

+39 030 6830559
info@elcomsrl.net

elcomledcomponents.com

Distributore per l'estero:
Ivela srl - Member of Starlight Group

Direzione artistica

ELCOM - Ufficio Marketing e comunicazione

Fotografie

Bordegoni srl - Stefano Ferrando, Studio Vetroblu

Stampa

Tipolitografia Pagani Srl

Anno

2023

elcom

IVELA.

IALUX
cruise to light

ZETAQLAB
Lighting Control Expert

O.
CREATIONS

elcomledcomponents.com

ELCOM SRL - MEMBER OF STARLIGHT GROUP

+39 030 6830559

info@elcomsrl.net

